

**B**

VS 10-75 CG OPTIMA  
VS 40-150 CG OPTIMA SUP  
VS 40-150 CG OPTIMA SUP-EXH

APPLICATION: AD2-S / AD2-R



common ground terminal GND



common terminal 24VAC

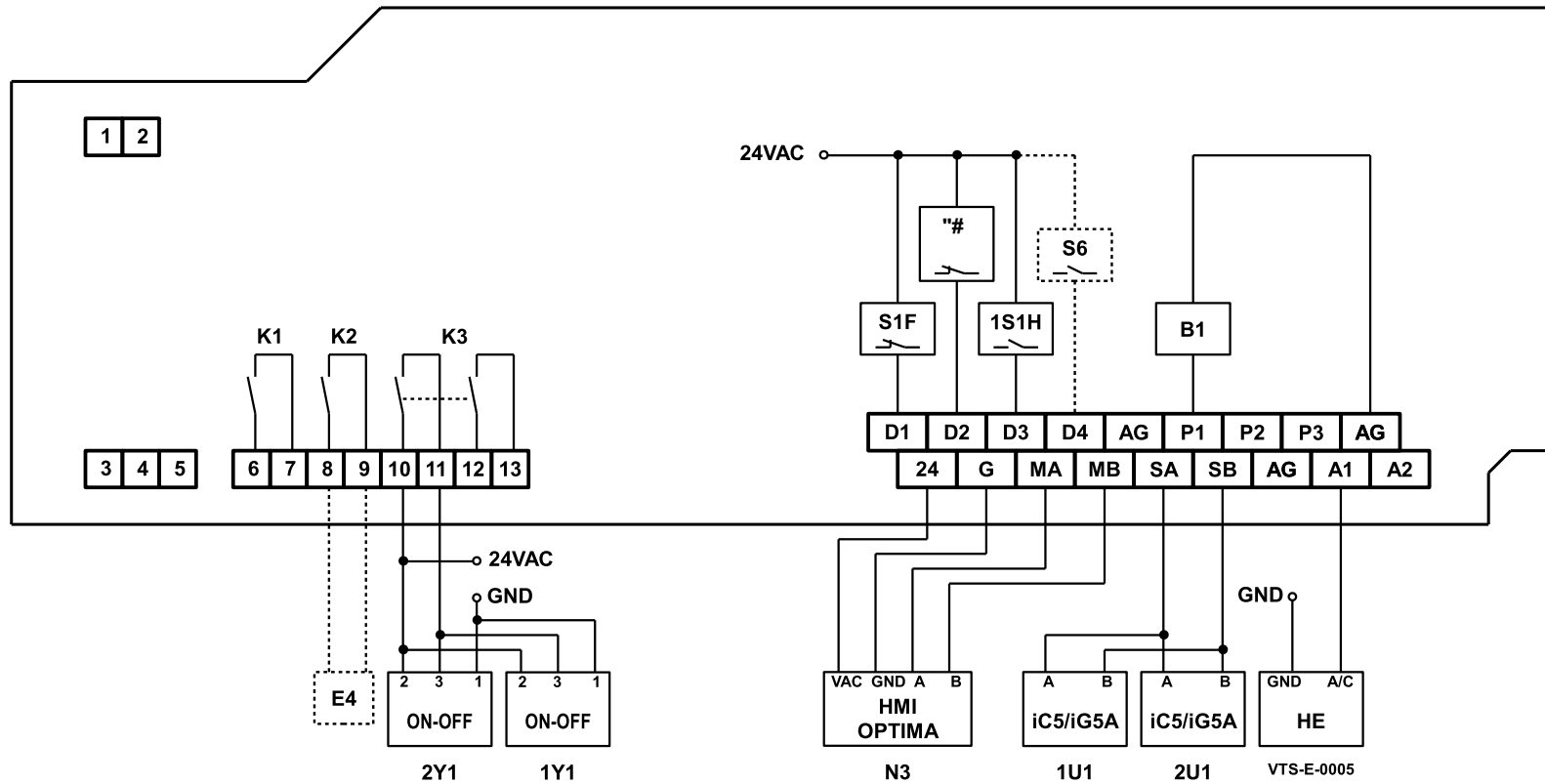

**B**

VS 10-75 CG OPTIMA  
VS 40-150 CG OPTIMA SUP  
VS 40-150 CG OPTIMA SUP-EXH

RS485 / Modbus connection details

