



EN

User Manual (Installation, Operation, and Maintenance Manual)

Compact air handling units

VENTUS COMPACT TOP VVS023c-VVS043c

CE

ventus

Content

1	HEALTH AND SAFETY INSTRUCTIONS	5
2	GENERAL INFORMATION	12
3	TRANSPORT AND STORAGE	15
4	THE UNIT INSTALLATION	19
4.1	LOCATION OF THE DEVICE.....	19
4.2	INSTALLATION OF <i>VENTUS COMPACT</i> AIR HANDLING UNIT.....	20
4.3	CONNECTING AIR DUCTS.....	25
4.4	REQUIREMENTS FOR EQUIPMENT TO BE INSTALLED ON THE SITE	26
4.5	CONNECTING BASE BLOCK SECTIONS	27
5	CONNECTION OF EXCHANGERS.....	30
5.1	CONNECTION OF WATER HEATERS AND COOLERS.....	30
5.2	CONNECTION OF DX EXCHANGERS (DIRECT EXPANSION)	33
5.3	CONDENSATE DRAINAGE	34
6	ELECTRICAL CONNECTION TO THE CONTROL PANEL	35
6.1	ELECTRICAL CONNECTION	35
6.2	CONNECTION OF THE VERSION WITHOUT FACTORY WIRING	36
7	ELECTRIC HEATER	38
7.1	GENERAL INFORMATION.....	38
7.2	HEATER POWER CONNECTION AND CURRENT PROTECTION	40
7.3	THERMAL CUT-OUT (THERMIC).....	43
7.4	DIFFERENTIAL PRESSURE SWITCH.....	44
7.5	CONNECTION OF ELECTRIC HEATER CONTROL	45
8	PLUG&PLAY CONTROL COMPONENTS	46
8.1	STANDARD EQUIPMENT WITH FACTORY-FITTED CONTROL ELEMENTS.....	47
8.2	CONNECTION TERMINAL 1 (T1).....	48
8.3	CABLE STANDARDS.....	49
8.4	ANALOGUE INPUTS (NTC10K)	50
8.4.1	SUPPLY AIR TEMPERATURE SENSOR B1	51
8.4.2	TOUCHSCREEN WATER HEATER TEMPERATURE SENSOR B5.....	52
8.5	DIGITAL INPUTS	53
8.5.1	FIRE ALARM SIGNAL DI1	54
8.5.2	WATER HEATER FROST SENSOR DI2.....	54
8.5.3	COLD SOURCE ALARM DI3.....	55



8.6	ANALOGUE OUTPUTS (0-10V DC).....	56
8.6.1	VALVE ACTUATOR OF THE WATER MAIN HEATER AND CONTROL SIGNAL OF THE ELECTRIC MAIN HEATER Y1	57
8.6.2	VALVE ACTUATOR FOR WATER PRE- OR RE-HEATER AFTER DX-H Y1	57
8.7	DIGITAL OUTPUTS (24V DC)	58
8.8	CONNECTION OF CONDENSING UNIT SIGNALS.....	59
8.9	CONNECTION OF THREE-WAY VALVES.....	60
8.10	CONNECTION OF AIR DAMPER ACTUATORS	61
8.11	MODBUS RTU RS485 COMMUNICATION	61
8.12	CONNECTION OF OPERATOR PANELS	62
8.12.1	HMI ADVANCED.....	62
8.12.2	HMI BASIC (2HY).....	63
8.12.3	WebHMI and VMS.....	64
8.12.4	mHMI APPLICATION - BLUETOOTH DEVICE PAIRING	65
9	FIRST START-UP	66
9.1	PREPARATION FOR THE FIRST START-UP	66
9.1.1	CHECKING THE CONDITION OF THE INSTALLATION	66
9.1.2	POWER CONFIGURATION OF OPTIONAL ELECTRIC HEATERS	68
9.2	FIRST START-UP	69
9.2.1	FACTORY PARAMETERS.....	69
9.2.2	COMMISSIONING	71
9.2.3	HMI ADVANCED.....	72
9.2.4	HMI BASIC 2HY	74
9.2.5	BLUETOOTH MODULE AND mHMI APPLICATION.....	79
9.2.6	OPERATING MODES OF THE CONTROL PANEL.....	90
9.2.7	VERIFICATION OF OPERATION DURING INITIAL START-UP	91
9.2.8	MEASUREMENT OF AIR VOLUME.....	93
9.2.9	THE MOST COMMON ADAPTATIONS TO THE NEEDS OF THE FACILITY	94
10	MAINTENANCE	97
10.1	MAINTENANCE	97
10.2	CONSUMABLES.....	102
10.2.1	FILTRY POWIETRZA	102
10.3	ELECTRIC HEATER DIAGRAM	105
10.3.1	LOW POWER – 6KW – VVS023c, VVS033c.....	105
10.3.2	LOW POWER – 6KW – VVS043c.....	106
10.3.3	HIGH POWER – 18KW – VVS023c, VVS033c.....	107

10.3.4	HIGH POWER – 24KW – VVS043c.....	108
10.3.5	HIGH POWER – 36KW – VVS023c, VVS033c.....	109
10.3.6	HIGH POWER – 48KW – VVS043c.....	110
10.3.7	HIGH POWER – 72KW – VVS043c.....	111
10.3.8	HIGH POWER – 54KW – VVS033c.....	112
10.4	UNIT WIRING DIAGRAM	113
10.4.1	PLUG&PLAY HEX (1/4)	113
10.4.2	PLUG&PLAY HEX (2/4)	114
10.4.3	PLUG&PLAY HEX (3/4)	115
10.4.4	PLUG&PLAY HEX (4/4)	116
11	SUPPLEMENTARY INFORMATION.....	118
11.1	TECHNICAL INFORMATION FOR REGULATION (EU) N327/2011 IMPLEMENTING DIRECTIVE 2009/125/EC.....	118
11.2	ASSOCIATED INSTRUCTIONS	120
11.3	DESCRIPTION OF UPC3 CONTROLLER SCREENS	120
11.4	DISMANTLING AND DISPOSAL OF AHU	121
11.5	NOTES.....	122
11.6	EU DECLARATION OF CONFORMITY.....	123

1 HEALTH AND SAFETY INSTRUCTIONS

Thorough familiarisation with the contents of this manual, as well as installation, commissioning and operation of the air handling unit in accordance with the instructions provided and in compliance with all applicable occupational health and safety regulations, will provide a sound basis for efficient, safe and trouble-free operation of the unit.

This document does not cover all possible configurations of these units, does not provide all examples of their assembly and installation, nor does it discuss all aspects of their commissioning, operation, repair and maintenance. If the units are used in accordance with their intended design purpose, both this documentation and any other materials dedicated to the supplied unit contain information intended exclusively for qualified technical personnel.

	<p>This symbol is displayed to indicate issues and operations that may involve a risk. Carefully read the section marked with this symbol and follow the instructions</p>
 <p>WARNING</p>	<p>Indicates that failure to follow the instructions may result in minor injury or damage to the product.</p>
 <p>DANGER</p>	<p>Indicates that failure to follow the instructions may result in serious injury or death.</p>

RECOMMENDATIONS REGARDING THE MANUAL

- Failure to follow the recommendations contained in this manual may result in property damage and personal injury. The manufacturer shall not be held liable for any damage that may result, directly or indirectly, from failure to observe these instructions.
- Depending on the configuration used, the unit may be supplied with additional manuals for the delivered components. It is strongly recommended to read and observe the safety requirements contained in those manuals.
- This manual and the air handling unit documentation, as well as any additional manuals for the components used, if available, must be carefully stored in a place that is easily accessible to operating and service personnel.



WARNING

INSTALLATION, SERVICE WORK AND USE

- ! BEFORE CARRYING OUT ANY WORK, DISCONNECT THE POWER SUPPLY AND SECURE IT AGAINST UNCONTROLLED START-UP OF THE AIR HANDLING UNIT. THE SERVICE WORK IN PROGRESS MUST BE COMMUNICATED AND CLEARLY MARKED.
- ! **THE UNIT IS FACTORY-CONFIGURED TO START AUTOMATICALLY WHEN THE POWER SUPPLY IS CONNECTED FOR THE FIRST TIME.**
- ! PERSONAL PROTECTIVE EQUIPMENT (PPE) MUST BE USED DURING WORK.
- ! IN PARTICULAR:
 - o CUT-RESISTANT GLOVES (EN 388) TO PROTECT HANDS AGAINST SHARP EDGES,
 - o SAFETY HELMET (EN 397) WHEN INSTALLING ABOVE HEAD HEIGHT, PROTECTIVE MASK TO PREVENT DUST AND DIRT PARTICLES FROM ENTERING THE LUNGS,
 - o SAFETY GOGGLES AND ANY OTHER PPE REQUIRED BY APPLICABLE REGULATIONS.
- ! ALL SERVICE ACTIVITIES MUST BE CARRIED OUT WITH THE UTMOST CARE.
- ! INSTALLATION, COMMISSIONING AND SERVICING OF AIR HANDLING UNITS AND THEIR EQUIPMENT MAY INVOLVE CERTAIN SAFETY HAZARDS AND THEREFORE REQUIRE SPECIFIC KNOWLEDGE AND TRAINING.
- ! INSTALLATION, COMMISSIONING AND OPERATION OF THE UNIT MUST BE CARRIED OUT BY A PERSON HOLDING THE APPROPRIATE QUALIFICATIONS REQUIRED BY APPLICABLE REGULATIONS.
- ! IT IS RECOMMENDED THAT INSTALLATION, COMMISSIONING, POST-WARRANTY REPAIRS, TECHNICAL INSPECTIONS AND MAINTENANCE WORK REQUIRED FOR AIR HANDLING UNITS BE CARRIED OUT BY A VTS-AUTHORIZED SERVICE PROVIDER.
- ! UNITS THAT ARE INCORRECTLY INSTALLED, ADJUSTED OR REPAIRED BY A PERSON WITHOUT THE REQUIRED QUALIFICATIONS MAY CAUSE SERIOUS PERSONAL INJURY OR EVEN DEATH. THE ABOVE RELEASES THE MANUFACTURER FROM LIABILITY AND FROM ANY OBLIGATIONS UNDER THE WARRANTY AND STATUTORY WARRANTY.
- ! THIS UNIT IS NOT INTENDED FOR USE BY PERSONS, INCLUDING CHILDREN, WITH REDUCED PHYSICAL, SENSORY OR MENTAL CAPABILITIES, OR WITHOUT EXPERIENCE AND KNOWLEDGE, UNLESS THEY ARE SUPERVISED OR HAVE BEEN INSTRUCTED IN THE USE OF THE UNIT BY A PERSON RESPONSIBLE FOR THEIR SAFETY.
- ! CHILDREN MUST BE SUPERVISED TO ENSURE THAT THEY DO NOT PLAY WITH THE UNIT.
- ! CLEANING AND USER MAINTENANCE MUST NOT BE CARRIED OUT BY CHILDREN WITHOUT SUPERVISION.
- ! THE UNIT MUST BE USED IN ACCORDANCE WITH ITS INTENDED PURPOSE AND WITHIN THE OPERATING PARAMETERS FOR WHICH IT HAS BEEN DESIGNED. IN THE EVENT OF IMPROPER USE, THE MANUFACTURER SHALL NOT BE HELD LIABLE FOR ANY RESULTING CONSEQUENCES.



DANGER

ELECTRICAL INSTALLATIONS

- ! ALL ELECTRICAL WORK MUST BE CARRIED OUT BY A LICENSED ELECTRICIAN HOLDING AT LEAST AN E1 QUALIFICATION CERTIFICATE FOR THE OPERATION OF EQUIPMENT, INSTALLATIONS AND NETWORKS, AND A D1 QUALIFICATION CERTIFICATE FOR THE SUPERVISION OF EQUIPMENT, INSTALLATIONS AND NETWORKS.
- ! IF THE UNIT IS EQUIPPED WITH COMPONENTS OR CONNECTED TO INSTALLATIONS THAT REQUIRE E2 AND D2 QUALIFICATIONS, THE INSTALLER AND THE TECHNICAL SUPERVISOR MUST HOLD SUCH QUALIFICATIONS.
- ! CONNECTIONS MUST BE MADE IN ACCORDANCE WITH THE GUIDELINES PROVIDED IN THIS DOCUMENT.
- ! MAKE SURE THAT THE MAINS SUPPLY VOLTAGE COMPLIES WITH THE INFORMATION PROVIDED ON THE RATING PLATES OF THE ELECTRICAL DEVICES. THE PERMISSIBLE DEVIATIONS ARE:
 - o SUPPLY VOLTAGE: +/- 5%
 - o FREQUENCY: +/- 2%
- ! IT IS ALSO RECOMMENDED TO CHECK THAT ALL EARTHING CONDUCTORS ARE PROPERLY SECURED.
- ! A DEDICATED CIRCUIT AND A MAIN SWITCH WITH A LOCKING DEVICE MUST BE INSTALLED. BEFORE STARTING ANY SERVICE OR MAINTENANCE WORK, SET THE MAIN DISCONNECT SWITCH TO THE OFF POSITION.
- ! INCORRECT WIRING OR INSTALLATION MAY CAUSE FIRE OR ELECTRIC SHOCK.
- ! DO NOT USE A DAMAGED OR INCORRECTLY SELECTED SWITCH OR CABLE.



WARNING

CAUTION! HOT PARTS

- ! THE UNIT CONTAINS COMPONENTS WHOSE SURFACE TEMPERATURE MAY BE HIGH, SUCH AS HEAT EXCHANGERS, HEATERS OR THE MOTOR HOUSING. DIRECT CONTACT WITH THESE PARTS MAY RESULT IN BURNS OR OTHER INJURIES. SPECIAL CARE MUST BE TAKEN, APPROPRIATE PROTECTIVE CLOTHING MUST BE WORN, AND SERVICE WORK MAY ONLY BE STARTED ONCE THEIR TEMPERATURE HAS FALLEN BELOW 40°C.

CAUTION! SHARP EDGES

- ! THE UNIT CONTAINS SHARP EDGES, FOR EXAMPLE HEAT EXCHANGER FINS. CONTACT WITH THEM MAY RESULT IN CUTS. THEREFORE, SPECIAL CARE MUST BE TAKEN AND PROTECTIVE CLOTHING MUST BE WORN.

CAUTION! MOVING PARTS

- ! THE UNIT CONTAINS MOVING PARTS, SUCH AS FAN IMPELLERS. CONTACT WITH THEM MAY RESULT IN CUTS OR SERIOUS INJURY. SERVICE WORK MAY ONLY BE STARTED AFTER THESE PARTS HAVE COME TO A COMPLETE STOP.
- ! OPENING INSPECTION PANELS WHILE THE AIR HANDLING UNIT IS OPERATING, OR STARTING THE UNIT WITH INSPECTION PANELS OPEN, IS STRICTLY PROHIBITED.
- ! BEFORE OPENING THE INSPECTION PANELS, SWITCH OFF THE AIR HANDLING UNIT AND WAIT FOUR MINUTES FOR ALL MOVING PARTS TO COME TO A COMPLETE STOP.



WARNING

RESIDUAL RISK

DURING THE DESIGN AND MANUFACTURING PROCESS OF THE UNITS, THE RISK TO PEOPLE AND PROPERTY HAS BEEN MINIMISED. NEVERTHELESS, A CERTAIN LEVEL OF RISK MAY STILL OCCUR WHICH IS BEYOND THE MANUFACTURER'S CONTROL:

- **HAZARDS RESULTING FROM INCORRECT INSTALLATION AND ASSEMBLY:**
 - INSTALLATION IN LOCATIONS ACCESSIBLE TO UNAUTHORISED PERSONS, WHICH MAY CREATE A RISK TO HEALTH AND LIFE.
 - INSTALLATION IN LOCATIONS WHERE SERVICE WORK IS DIFFICULT OR DANGEROUS TO HEALTH OR LIFE.
 - ACCUMULATION AND LEAKAGE OF CONDENSATE, WHICH MAY LEAD TO PROPERTY DAMAGE, ELECTRICAL SHORT CIRCUITS OR SLIPPERY SURFACES.
 - LEAKAGE OF REFRIGERANT OR HEATING MEDIUM FROM THE CIRCUIT, CREATING A RISK TO HEALTH AND LIFE AND CAUSING PROPERTY DAMAGE.
 - FALLING OF A UNIT INSTALLED ON AN UNSUITABLE SUPPORT STRUCTURE, CREATING A RISK TO HEALTH AND LIFE AND CAUSING PROPERTY DAMAGE.
- **HAZARDS RESULTING FROM INCORRECT TRANSPORT:**
 - FALLING OR TIPPING OVER OF THE TRANSPORTED UNIT OR ITS COMPONENTS, CREATING A RISK TO HEALTH AND LIFE AS WELL AS TO PROPERTY.
- **HAZARDS RESULTING FROM INCORRECT STORAGE:**
 - STORAGE UNDER CONDITIONS THAT MAY LEAD TO DAMAGE, DEFORMATION OR CHANGES IN THE PROPERTIES OF THE UNIT OR ITS COMPONENTS, AS A RESULT OF WHICH THE UNIT MAY OPERATE INCORRECTLY OR FAIL TO MEET THE DECLARED REQUIREMENTS.
- **HAZARDS RESULTING FROM INCORRECT ELECTRICAL INSTALLATION:**
 - SHORT CIRCUITS, FIRES AND THE RELEASE OF TOXIC FUMES, WHICH CONSTITUTE A REAL RISK TO HEALTH AND LIFE AND MAY LEAD TO PROPERTY DAMAGE.
 - OPERATION OF THE UNIT WITHOUT FITTED PANELS AND PROTECTIVE GUARDS:
 - CONTACT WITH MOVING OR HOT PARTS MAY CREATE A RISK TO HEALTH AND LIFE.



WARNING

FAULTS, REPAIRS, MODIFICATIONS

- ! IF A FAULT OR INCORRECT OPERATION OF THE UNIT IS DETECTED, THE UNIT MUST BE SWITCHED OFF IMMEDIATELY AND AN AUTHORISED SERVICE PROVIDER MUST BE CONTACTED.
- ! ALL REPAIRS MUST BE CARRIED OUT BY THE MANUFACTURER'S AUTHORISED SERVICE PROVIDER, USING ORIGINAL SPARE PARTS.
- ! ROUTINE INSPECTIONS CARRIED OUT BY QUALIFIED TECHNICAL PERSONNEL OR BY A VTS-AUTHORISED SERVICE PROVIDER ENSURE LONG-TERM, RELIABLE AND TROUBLE-FREE OPERATION OF THE UNITS. OUR SERVICE PERSONNEL ARE AVAILABLE AT ALL TIMES TO PROVIDE SUPPORT DURING COMMISSIONING, MAINTENANCE AND IN THE EVENT OF ANY EMERGENCY SITUATIONS RELATED TO THE OPERATION OF THE UNIT.
- ! VTS-AUTHORISED SERVICE STATIONS SELL SPARE PARTS AND ACCESSORIES FOR OUR AIR HANDLING UNITS. WHEN ORDERING PARTS, PLEASE PROVIDE THE AIR HANDLING UNIT TYPE, SIZE AND SERIAL NUMBER.



INFORMATION FOR USERS ON THE PROPER HANDLING OF WASTE ELECTRICAL AND ELECTRONIC EQUIPMENT (WEEE).

WITH REFERENCE TO EUROPEAN UNION DIRECTIVE 2002/96/EC OF 27 JANUARY 2003 AND THE RELATED NATIONAL REGULATIONS, PLEASE NOTE THAT:

- ! WASTE ELECTRICAL AND ELECTRONIC EQUIPMENT (WEEE) MUST NOT BE DISPOSED OF AS MUNICIPAL WASTE. SUCH WASTE MUST BE COLLECTED AND DISPOSED OF SEPARATELY.
- ! PUBLIC OR PRIVATE WASTE COLLECTION SYSTEMS SPECIFIED IN LOCAL REGULATIONS MUST BE USED.
- ! THE EQUIPMENT MAY CONTAIN HAZARDOUS SUBSTANCES. IMPROPER USE OR INCORRECT DISPOSAL OF SUCH SUBSTANCES MAY HAVE A NEGATIVE IMPACT ON HUMAN HEALTH AND THE ENVIRONMENT.
- ! THE SYMBOL OF THE CROSSED-OUT WHEELED BIN, PLACED ON THE PRODUCT, PACKAGING OR TECHNICAL LEAFLET, MEANS THAT THE EQUIPMENT WAS PLACED ON THE MARKET AFTER 13 AUGUST 2005 AND MUST BE DISPOSED OF SEPARATELY.
- ! BY SORTING AND HANDING OVER WASTE ELECTRICAL AND ELECTRONIC EQUIPMENT FOR PROCESSING, RECOVERY, RECYCLING AND DISPOSAL, YOU PROTECT THE ENVIRONMENT AGAINST POLLUTION AND CONTAMINATION, HELP REDUCE THE USE OF NATURAL RESOURCES AND LOWER THE COST OF MANUFACTURING NEW EQUIPMENT.
- ! IN THE EVENT OF ILLEGAL DISPOSAL OF ELECTRICAL AND ELECTRONIC WASTE, PENALTIES ARE SPECIFIED IN LOCAL WASTE DISPOSAL REGULATIONS.



DANGER



EMERGENCY SITUATIONS – FIRE

PROCEDURE IN THE EVENT OF A FIRE INVOLVING ELECTRICAL EQUIPMENT:

KEEP CALM - DO NOT PANIC, ASSESS THE SITUATION.

DISCONNECT THE POWER SUPPLY:

- IF POSSIBLE, CUT OFF THE POWER SUPPLY, E.G. BY SWITCHING OFF THE FUSES OR THE MAIN SWITCH.
- DO NOT TOUCH THE UNIT OR CABLES WITH BARE HANDS, AS THEY MAY STILL BE LIVE.

CALL FOR HELP:

- CALL THE EMERGENCY NUMBER.
- PROVIDE THE EXACT ADDRESS AND A BRIEF DESCRIPTION OF THE SITUATION.

EXTINGUISHING THE FIRE:

DO NOT USE WATER! WATER CONDUCTS ELECTRICITY AND MAY CAUSE ELECTRIC SHOCK.

- USE SUITABLE FIRE-FIGHTING EQUIPMENT:
 - CO₂ FIRE EXTINGUISHER, CARBON DIOXIDE, RECOMMENDED FOR EXTINGUISHING LIVE ELECTRICAL EQUIPMENT.
 - ABC POWDER FIRE EXTINGUISHER, MAY BE USED, BUT MAY DAMAGE ELECTRONIC COMPONENTS.

EVACUATION:

- IF THE FIRE IS SERIOUS OR CANNOT BE EXTINGUISHED SAFELY, LEAVE THE ROOM AND CLOSE THE DOOR BEHIND YOU TO LIMIT THE OXYGEN SUPPLY.
- HELP OTHERS LEAVE THE BUILDING.
- DO NOT USE LIFTS.

IN THE EVENT OF A FIRE, there is a risk to health and life due to high temperature, heavy smoke and the release of harmful gases, including carbon monoxide, carbon dioxide, hydrogen chloride, hydrogen cyanide and dioxins.

! THE USE OF RESPIRATORY PROTECTIVE EQUIPMENT (RPE) IS REQUIRED!

2 GENERAL INFORMATION

Floor-mounted VENTUS COMPACT TOP VVS023c-VVS043c air handling units (AHUs) are designed for indoor installation. The low height of the unit allows it to fit perfectly into standard inter-floor spaces or spaces above suspended ceilings.









VENTUS VVS023c-VVS043c air handling units are designed to operate with supply and extract air duct systems, in accordance with the ventilation design. Connection of the air ducts prevents access to the rotating parts of the unit, such as the fan impeller.

The nominal parameters of the unit are specified in the unit selection sheet.



- ! IT IS STRICTLY FORBIDDEN TO OPEN THE INSPECTION PANELS WHILE THE AIR HANDLING UNIT IS IN OPERATION OR TO START UP THE AIR HANDLING UNIT WITH THE INSPECTION PANELS OPEN.
- ! SWITCH OFF THE CONTROL UNIT AND WAIT TWO MINUTES FOR ALL ELEMENTS IN MOTION TO STOP BEFORE OPENING THE INSPECTION PANELS.
- ! DISCONNECT AND SECURE THE POWER SUPPLY TO PREVENT UNCONTROLLED START-UP OF THE CONTROL PANEL.
- ! AN CONTROL SYSTEM IS REQUIRED TO ENSURE CONTROL OF OPTIMAL OPERATION OF THE UNIT AND TO PROTECT THE UNIT AGAINST FAILURE. THE AUTOMATICS MUST INDICATE THE DEGREE OF DIRTINESS OF THE AIR FILTERS.

The unit is equipped with a number of duct functions and accessories and an Control system. The unit's functions and their parameters are given in the selection sheet generated from the manufacturer's IT system according to the design guidelines.

FUNCTION		FUNCTIONAL VERSIONS				
F	Air filter		Air filter initial		Air filter secondary	
V	Fan					
H	Heater		Heater Water		Heater Electric	
S	Noise suppressor					
E	Empty section					

OTHER DESIGNATIONS IN THE CONTROL PANEL

AD	Air damper	
FLX.CON	Flexible duct connection	
IN	Inlet (supply of e.g. medium)	
OUT	Outlet (return e.g. medium)	

VENTUS COMPACT units have inspection panels located at the front of the unit.

BASE BLOCK DIMENSIONS BY SECTION

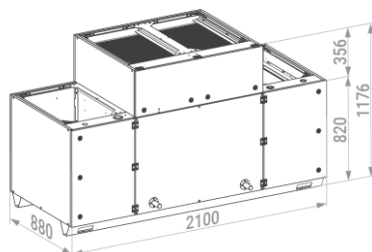

VVS023c

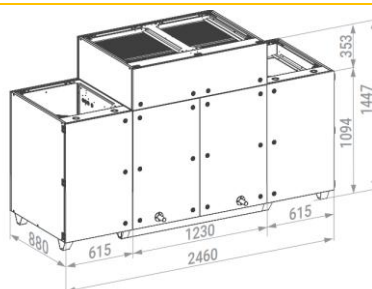

VVS033c

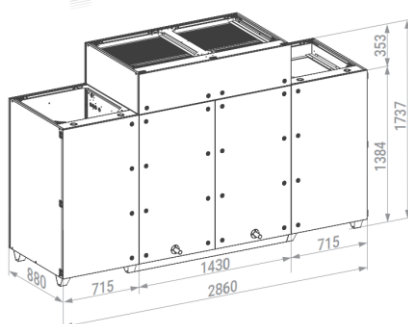

VVS043c

The units can be manufactured as right- or left-sided. The orientation of the unit is determined by the direction of airflow in the supply path (air outlet) in relation to the side of the unit where the inspection panels are located.

The units can be manufactured as right- or left-sided. The orientation of the unit is determined by the direction of airflow in the supply (bottom) path relative to the side of the unit where the inspection panels are located.

**AIR INLET AND OUTLET DESIGNATION
INSPECTION SIDE VIEW - RIGHT-HAND VERSION**

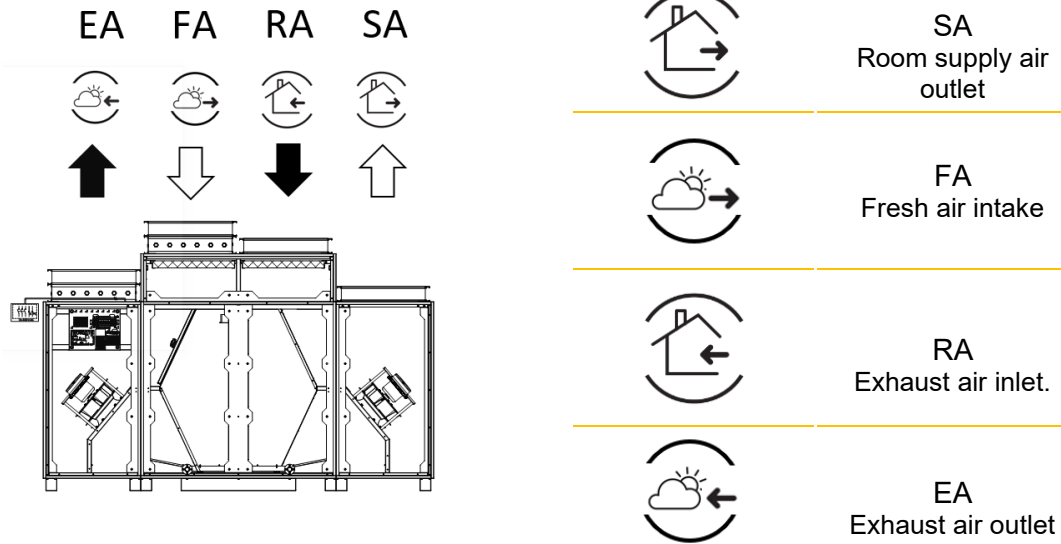

**AIR INLET AND OUTLET DESIGNATION
INSPECTION SIDE VIEW - LEFT-HAND VERSION**

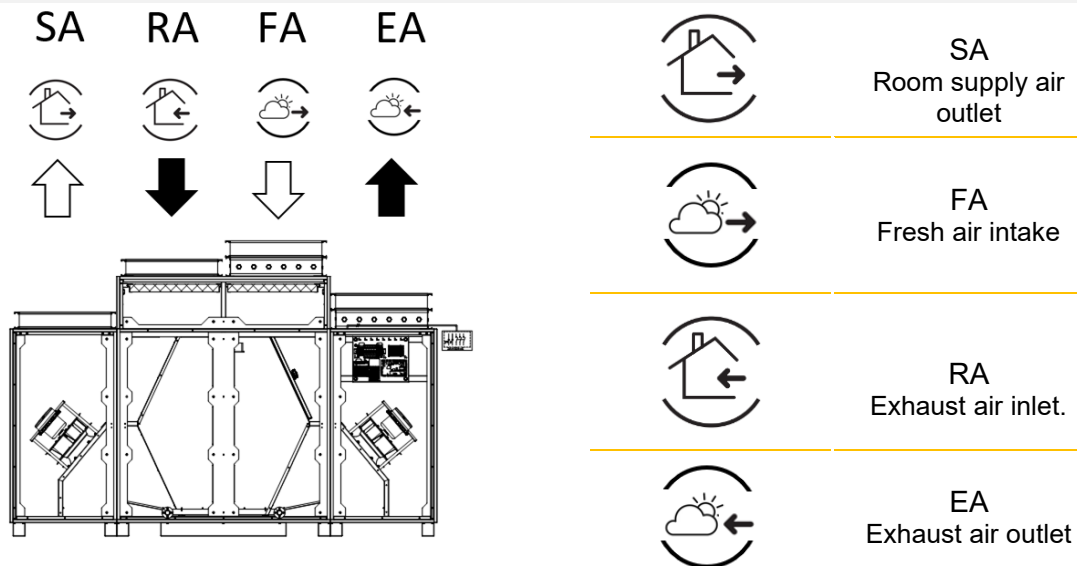

3 TRANSPORT AND STORAGE

The air handling units are packaged for easy internal transport and storage at the installation site. Upon delivery of the unit, all components must be checked to ensure that no damage has occurred in transit. Detailed instructions for this are included in the table Checklist on receipt.

Immediately upon receipt of the consignment with the equipment, a check for transport damage must be carried out according to the points in the checklist.

ACCEPTANCE CHECKLIST	
1	All individual packages must be checked before accepting the consignment. Check packaging for damage and completeness according to the consignment note.
2	If any device (package) appears to be damaged, it should be inspected immediately before accepting the entire consignment. Appropriate, damage-related entries should also be made on the consignment note. Delivery should not be refused.
3	Check the appliance immediately after delivery and before storage for concealed damage. Report concealed damage to the carrier within the time limit specified for this purpose from the date of delivery. Check with the carrier its deadline for making a claim.
4	Do not move the damaged appliance from the place to which it was delivered directly from the delivery. It is the responsibility of the recipient of the delivery to provide adequate evidence that the concealed damage has not already occurred after delivery.
5	If the unit in question appears to be damaged, stop unpacking it. Save all internal packaging, cartons and boxes. If possible, take photographs of the damage.
6	Immediately notify the carrier of the identified damage: by telephone and email in accordance with the procedure. Immediate joint damage control by a joint team of the carrier and consignee of the shipment should be requested.
7	Notify the VTS representative of the damage found and make arrangements for repair. The carrier's representative should inspect the damage before repairing it.
8	Compare the electrical data on the unit's rating plate with that on the order and in the shipping documentation to check that the unit received is correct.



- ! Any damage caused as a result of incorrect transport, unloading or storage is not covered by the guarantee and any claims submitted for cases of the above nature will not be considered by VTS.
- ! VENTUS COMPACT AHUs are supplied in assembled functional sections that need to be connected on site.
- ! The delivery of the control panels and their optional equipment becomes the property of the customer when the bill of lading is signed by the customer's representative.
- ! The opening, by the customer, of sealed transport packages before the arrival of the VTS Authorised Service Centre involves assuming full responsibility for the contents and completeness of the delivery.
- ! Immediately upon receipt of the equipment, the condition of the packaging and the completeness of the delivery should be checked on the basis of the enclosed specifications and waybills.
- ! The unloading of parcels with PBX components from the means of transport, their transport to the installation site and the transport of PBX components or blocks to the foundation site must be carried out using specialised equipment (e.g.: forklift, crane) and suitably qualified personnel.

RULES FOR THE TRANSPORT OF AHU SECTIONS

- ! The air handling units must be transported in the position and in the manner marked on the original manufacturer's packaging.

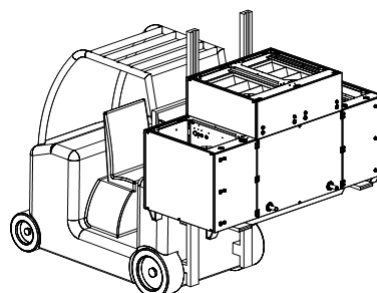
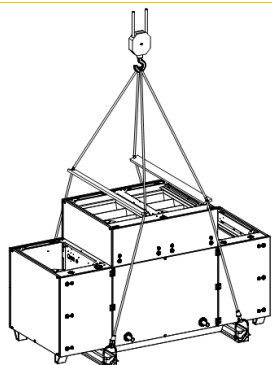

VVS023c

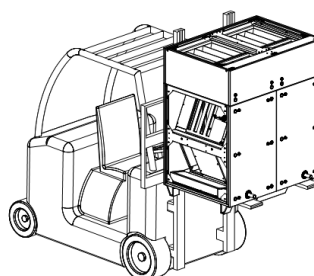
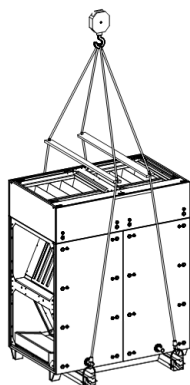

VVS033c , VVS043c



! **Equipment packaging:**

- should be placed in paved, dry locations protected from precipitation,
- should be placed and stored away from areas with active mechanical equipment (vehicles, cranes and other construction machinery),
- should be stored in places where they will not be exposed to any mechanical damage: moisture, aggressive chemicals, liquids, dust and any other external factors whose influence may impair their technical and functional condition.

VTS recommends leaving the units and their equipment in their transport packaging on pallets for protection and facilitating proper positioning during installation.



- ! The equipment as well as its components should be:
 - stored in rooms with the following conditions:
 - relative humidity: $\phi < 80 \%$, at $t = (+20) ^\circ\text{C}$,
 - ambient temperature: $(-40) ^\circ\text{C} < t < (+60) ^\circ\text{C}$.
 - protected from contact with corrosive (caustic) dusts, gases or vapour, as well as with any other chemical substances liable to have a corrosive effect on the equipment or its accessories.
- ! The inside of the air handling unit and all unit components, in particular air filters, must be protected against moisture and contamination from the surroundings, such as dust, dirt and other impurities.
- ! The air filters should be stored in their original packaging or in another manner that provides protection against contamination.
- ! All air filters must also be protected against direct sunlight, which may adversely affect the filter media and structural components of the filter. It is recommended to store filters in a dry, clean and shaded place.

4 THE UNIT INSTALLATION

Transport of the equipment requires lifting equipment at the installation site. Make sure that once the unit is installed, there will be enough space to properly bring the technological and electrical installations to the unit and to carry out maintenance on the unit without any problems.

4.1 LOCATION OF THE DEVICE

Allow adequate space for the placement of piping and electrical connections. All piping and ducting should be fixed independently of the air handling unit to reduce excessive noise and vibration.

RECOMMENDATIONS FOR THE LOCATION OF THE DEVICE

1	The weight of the appliance must be taken into account. When doing so, refer to the weight of the appliance on its rating plate. The weight on the rating plate does not take into account the weight of the media, which should be taken into account when installing the appliance.
2	Sufficient space should be left to allow for the removal of enclosure panels and for access to carry out maintenance work.
3	The installer must provide a lifting device to lift the panel or heavier panel components.
4	All equipment must be mounted horizontally.
5	Consideration should be given to the requirements for coil and drain pipework and condensate drainage.

4.2 INSTALLATION OF VENTUS COMPACT AIR HANDLING UNIT



- ! The control panel should be located on:
 - foundation screed,
 - concrete cast into the floor of the steel foundation frame,
 - a specially prepared rigid steel structure
- ! The foundation, frame or steel structure must be flat and level and should have sufficient strength to match the weight of the control panel including the weight of the media.
- ! The foundation, frame or steel structure must be flat and level and should have sufficient strength to match the weight of the panel.
- ! In stacked units, the part of the upper unit which projects beyond the contour of the lower unit must be supported by a suitable substructure (See SUPPORTING THE TOP BLOCKS OF AHUS).
- ! The height of the screed or foundation frame must allow for the installation of a drip tray drain trap. For drip trays installed in the lower sections of the air handling unit, it is necessary to provide the unit with an additional foundation or to create a recess in the floor directly under the siphon. (See DRIPPING).
- ! Any optional section that is present in the upper air path requires adequate support.
- ! The dimensions of the base block and additional functions are available in the unit's technical data sheet.

VVS023c AHU FOUNDATION LAYOUT

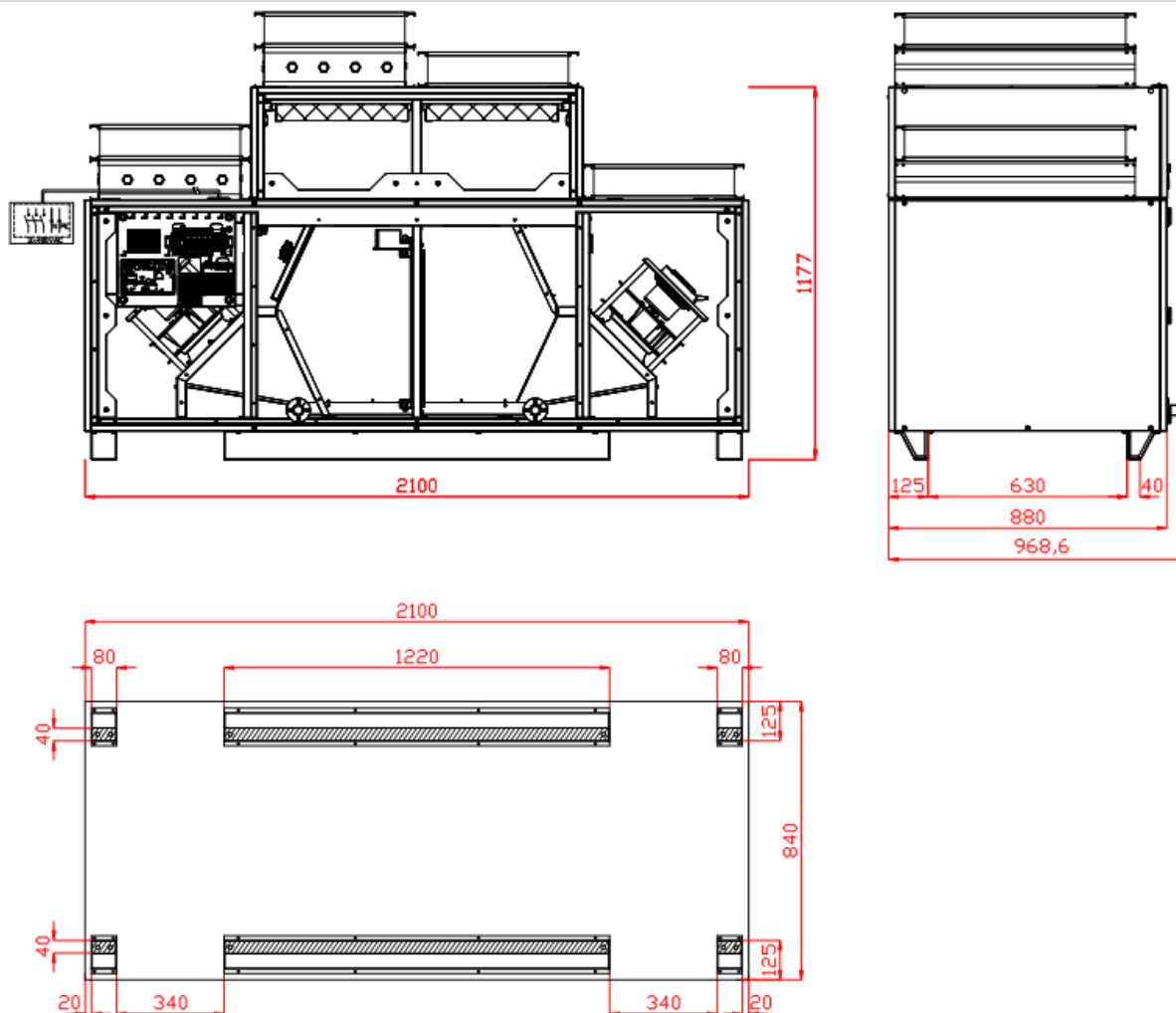

! The dimensions of the base block and additional functions are available in the unit technical data sheet.

VVS033c AHU FOUNDATION LAYOUT

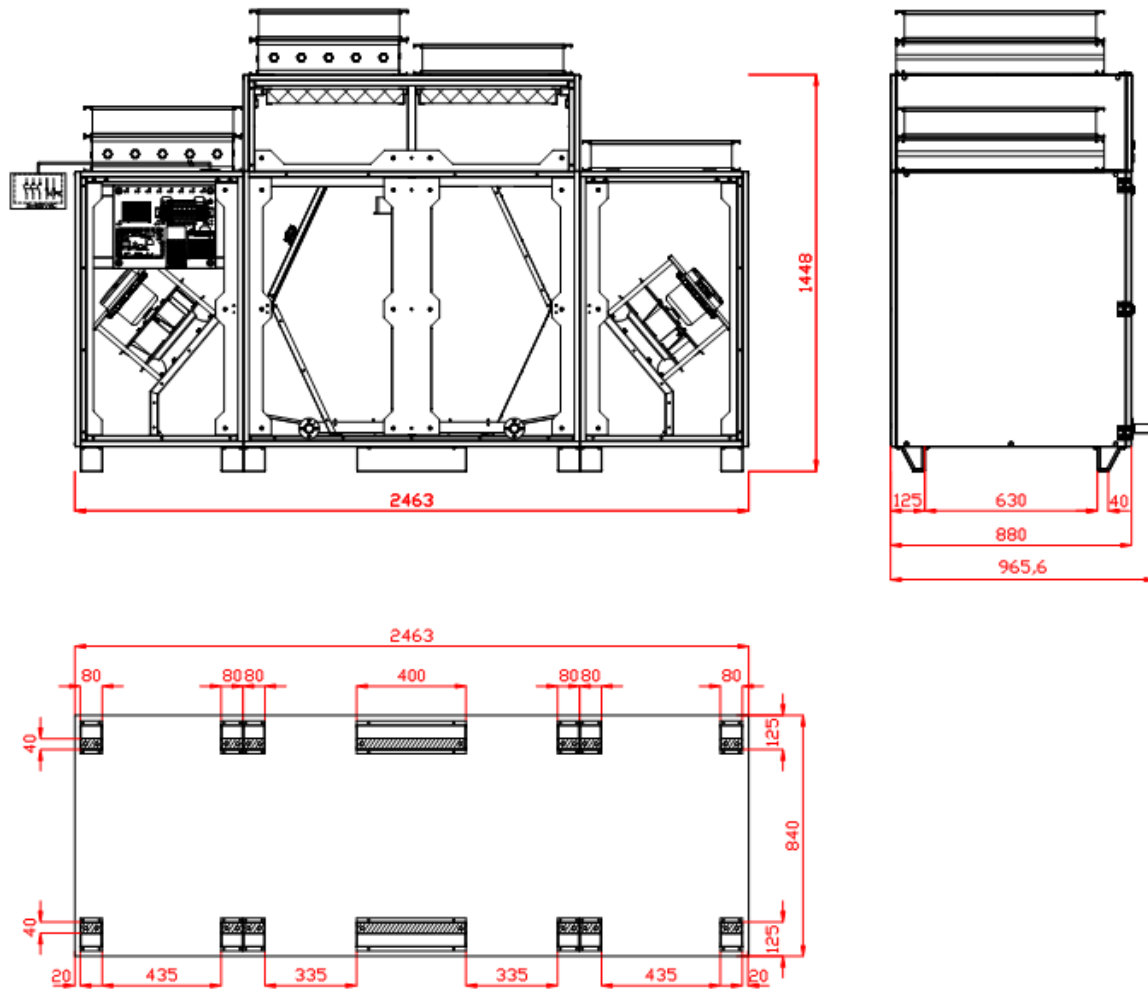

- ! The dimensions of the base block and additional functions are available in the unit technical data sheet.

VVS043c AHU FOUNDATION LAYOUT

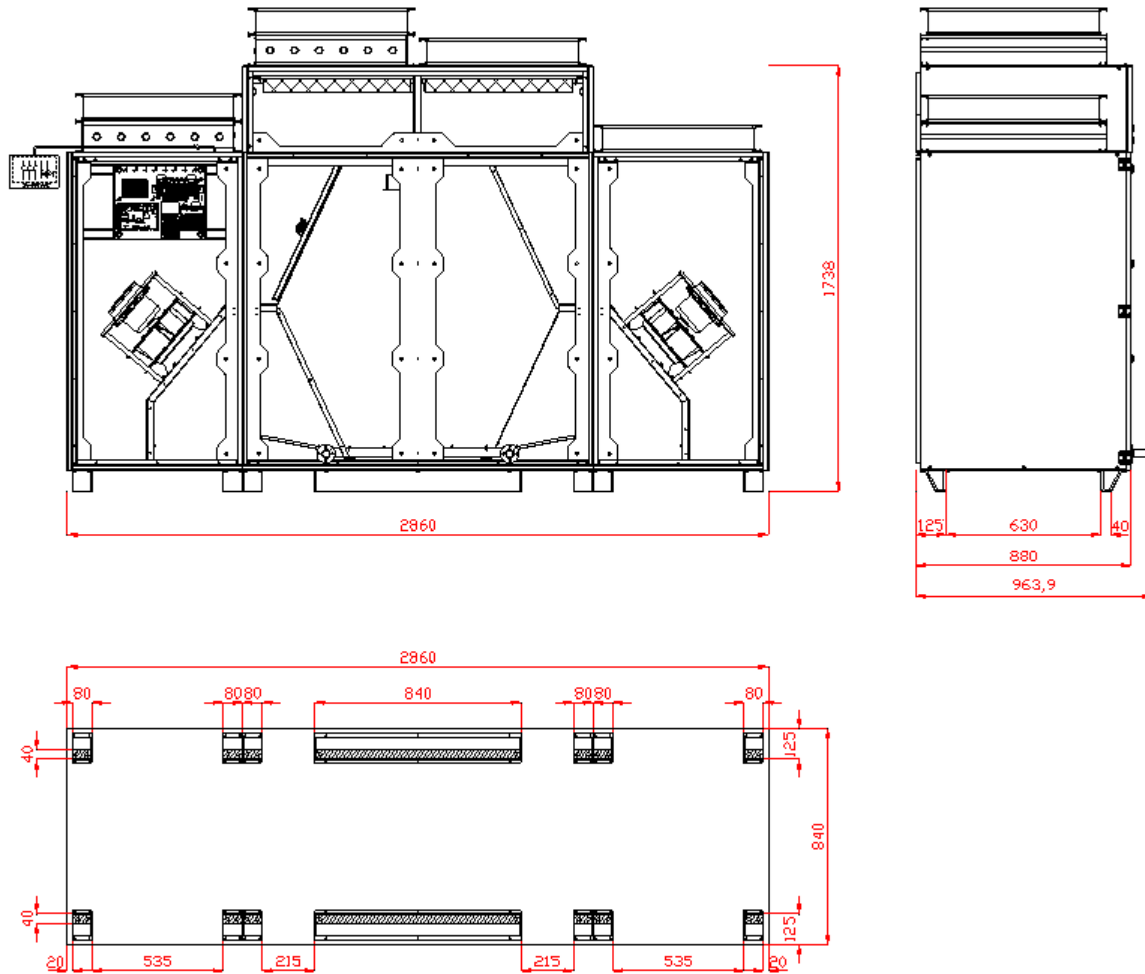

! The dimensions of the base block and additional functions are available in the unit technical data sheet.

FIXING OF THE FRAME/FOOTPLATE TO THE GROUND

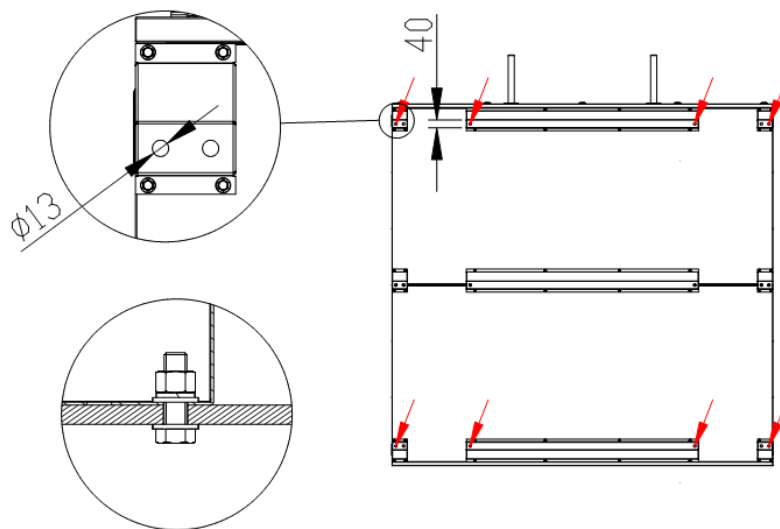

! The frame should be fixed through the extreme holes in the feet/frame.



- ! All profiles of the panel frame must be supported.
- ! Use M10 screws or dowels to secure the frames to the foundation.
- ! Frame deflection of 1mm/1m must not be exceeded
- ! The extreme foundation holes in the longitudinal profiles of the frames can be used for anchoring the HV frames (footers).

CONDENSATE DRAINAGE

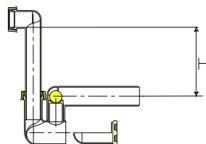

! When planning the foundation of the unit, provision must be made to drain the condensate from the drip trays.

H [mm] = total fan discharge in mm water column ($\text{Pa} \times 0.1$)

- ! The dimensions of the base block and additional functions are available in the unit's technical data sheet.

4.3 CONNECTING AIR DUCTS

INSTALLATION OF AIR DUCTS

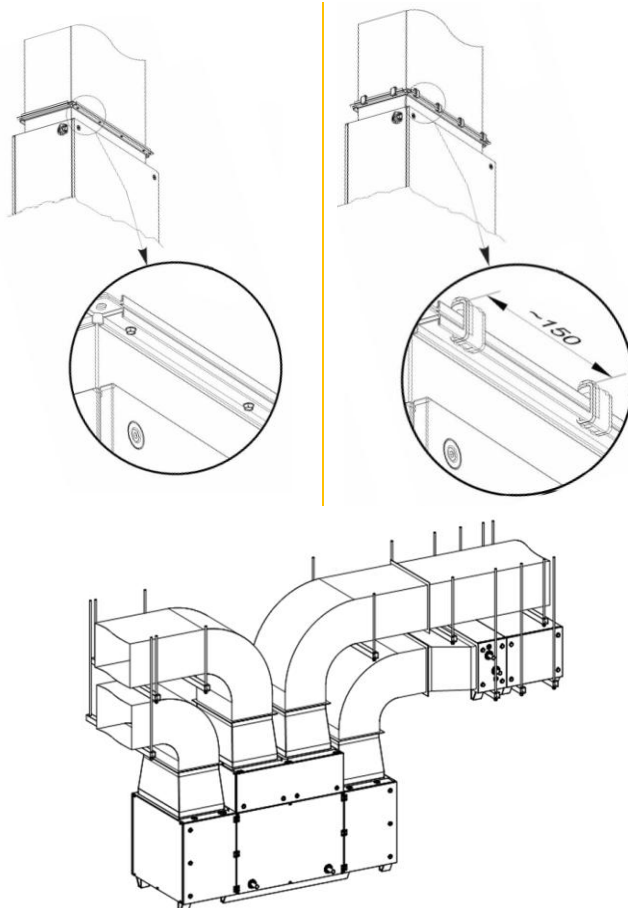

Air ducts should be connected to the air handling unit with flexible connections (optional equipment) that dampen unit vibrations and compensate for the misalignment of duct and air handling unit outputs.

Flexible connections are fitted with sealed flanges. Flexible flanges should be connected to the ducts using self-tapping screws or additional clamping elements.

The components used to connect the ducts are not included in the standard delivery.

Air ducts must not support their weight on the air handling unit!

DIMENSIONS OF AIR DUCT CONNECTION OPENINGS

	BASE BLOCK	DUCT-MOUNTED FUNCTIONS (ADD-ON SECTIONS)
VVS023c	700x445	860x345
VVS033c	700x513	860x480
VVS043c	700x613	1065x480

4.4 REQUIREMENTS FOR EQUIPMENT TO BE INSTALLED ON THE SITE

BASIC CONDITIONS FOR ASSEMBLY ON SITE - DELIVERY IN SECTIONS	
1	Section connection is outside the standard VTS offer. It is possible to purchase an additional option of section connection by an Authorised VTS Service.
2	Assembly may take place at ambient temperatures which allow all technical assembly procedures to be carried out correctly, i.e. in the temperature range: from (+5)° C to (+35) C.°
3	In the case of outdoor installation, the installation process can be carried out in conditions that ensure the absence of precipitation. It is permissible to start installation provided that all safety requirements are met.
4	Installation is carried out on site. Preparation of the unit's foundation site (frame, foundation, etc. is on the customer's side). Attention must be paid to the requirement described in this manual.
5	The following are required for the installation site: <ul style="list-style-type: none"> • access to power supply 1~ 230V, • adequate lighting of the installation site, • providing a safe environment for the installation team, • availability of individual panel components or pallets including packaging at the site of the specific panel, • ensures that AHU components and AHU blocks are transported to the installation site, • the possibility for the service to enter the site and begin installation immediately upon arrival, • provision of the warranty card and delivery documents for the specific PBX for the installation service.
6	When installing on your own, follow the separate instructions provided with the AHU in the installation kit. The instructions are available on the manufacturer's website.
7	When connecting the section, care must be taken to ensure that the "D" gasket, which is part of the section assembly kit, is correctly applied (a connection made without using the enclosed gasket will result in the housing not being airtight - warranty claims for this reason will not be considered).

4.5 CONNECTING BASE BLOCK SECTIONS

BASE BLOCK ASSEMBLY

RIGHT-HAND

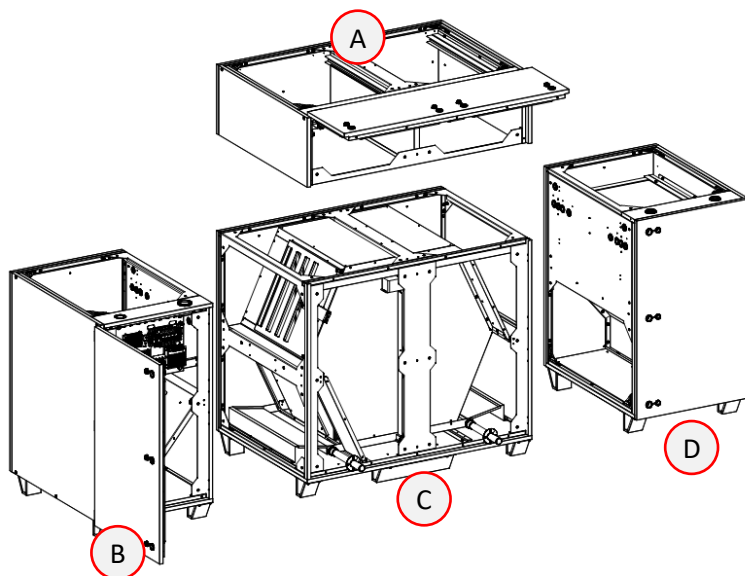

A - air filter section

B - extract fan section with control cabinet

C - heat recovery section with a hexagonal counter-flow heat exchanger and by-pass function

D - supply fan section. Optionally, the section is equipped with a water heater.

LEFT-HAND

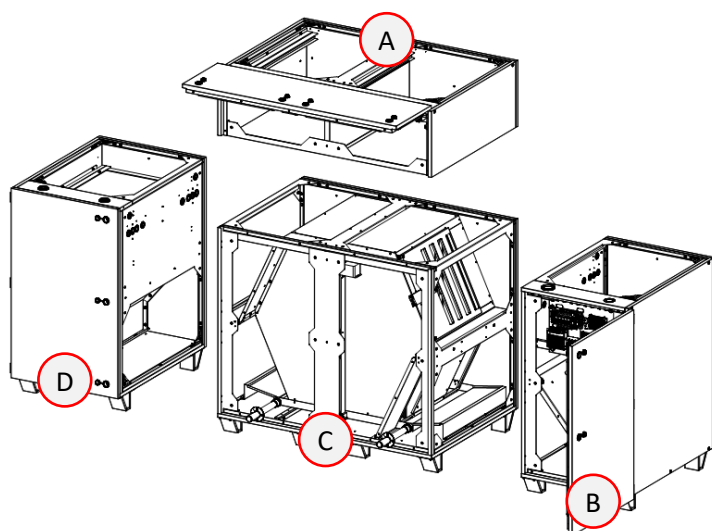

- ! Sekcje B, C, D w modelu VVS023c są dostarczane jako jedna nierozbieralna sekcja BCD.

BASE BLOCK ASSEMBLY

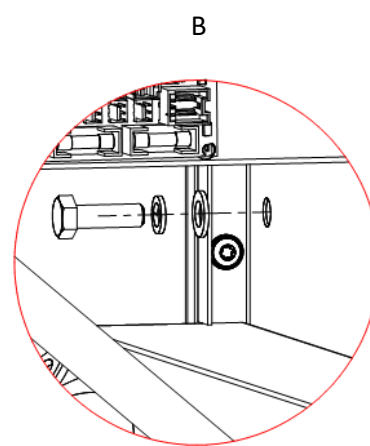
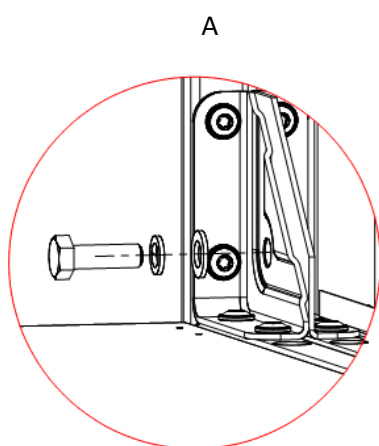
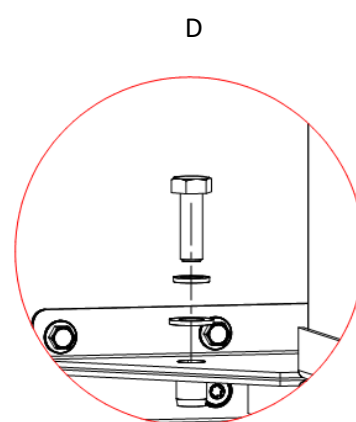
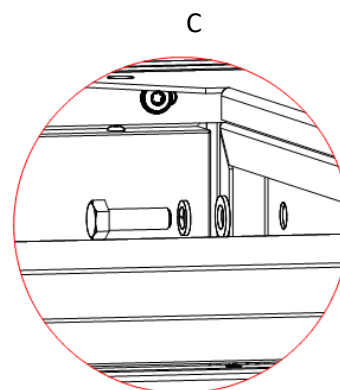
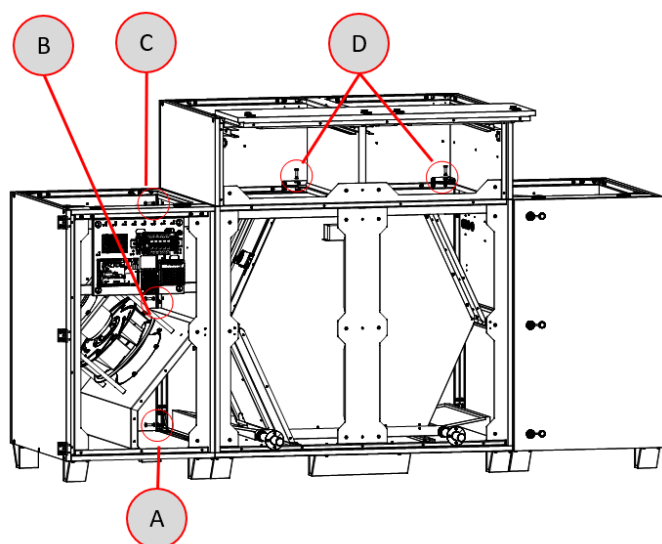

CONNECTING THE FAN SECTION

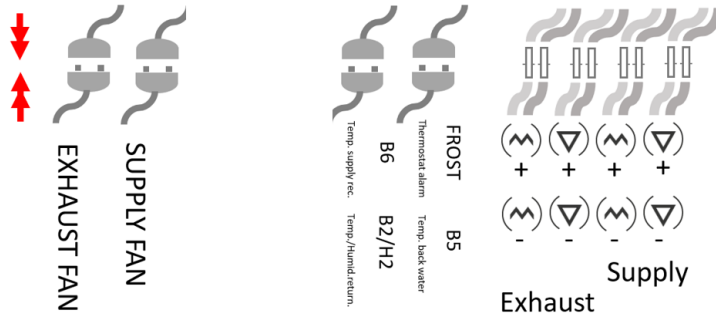

The VENTUS COMPACT base configuration with heat recovery is supplied as a wired unit with the Control system connected and configured. Using the supplied connectors (electrical cable, pneumatic cable), connect the fan and air filtration sections to the base section (with heat pump).

"+" higher pressure side (red wire), "-" lower pressure side (blue wire),

5 CONNECTION OF EXCHANGERS

5.1 CONNECTION OF WATER HEATERS AND COOLERS



- ! The operation of the water exchanger requires its connection to the heat system process depending on the designed function of this exchanger.
- ! Exchangers must be protected against freezing (if there is a risk of this).
- ! The connection of additional heat exchangers must be carried out in such a way that no stresses are caused which could result in mechanical damage or leaks. The weight of the pipes and thermal stress must not be transferred to the exchanger connections.
- ! Supply lines should be routed to avoid collision with other sections of the air handling unit and other installations.
- ! It must be possible to easily disconnect the heat exchangers from the process heat installation for maintenance and servicing.
- ! Compensation should be used at the inlet and outlet of the joints to compensate for linear expansion of the pipes.
- ! Hydraulic lines must not be routed over electrical lines.

QUALITY REQUIREMENTS FOR THE SUPPLY MEDIUM WATER EXCHANGERS

- ! Oil and grease < 1 mg/l ! pH at (+25) °C 8-9.
- ! Oxygen < 0.1 mg/l (as low as possible).
- ! Minimum radiator temperature (+3) °C.
- ! Maximum operating temperature (+130) °C.
- ! Maximum operating pressure 16 bar.
- ! At sub-zero flow temperatures, a freezing point-lowering additive, e.g. glycol, should be used (up to a maximum of 50% in the mixture).
- ! Water hardness no greater than:
 - normal concentration = 4.101 [mval/l] [mval/dm³]
 - molar concentration = 2.051 [mmol/l] [mmol/dm³].
 - Ca⁺²/l = 82.189 [mg Ca⁺²/l] [mg Ca⁺²/dm³].
 - CaCO₃ = 205.25 [mg CaCO₃/l] [mg CaCO₃/dm³] (ppm)
 - French degrees = 20.525 [°F] [°TH].
 - English degrees = 14,400 [°e] [grain CaCO₃/gal(UK)]
 - US = 11.990 [grain CaCO₃/gal(US)].
 - CaO = 115,000 [mg CaO/l] [mg CaO/dm³].
 - German degrees = 11,500 [°n] [°dH].



SECURING THE SCREWED CONNECTIONS OF THE WATER EXCHANGER

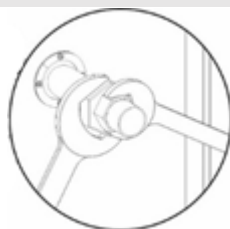

- ! When assembling the supply system for exchangers equipped with bolted connections, the exchanger connector must be relieved with an additional spanner.



WATER HEAT EXCHANGER CONNECTIONS IN THE BASE SECTION

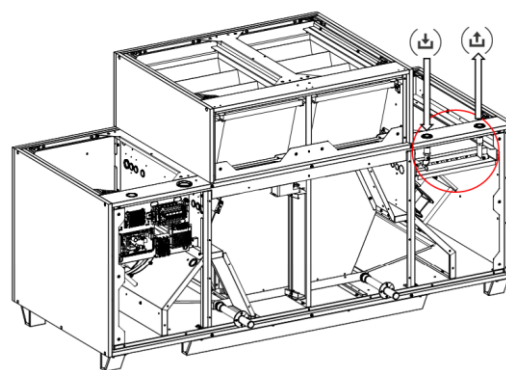
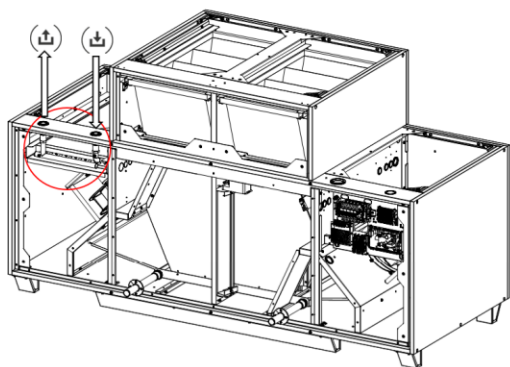



SUPPLY PRINCIPLE FOR WATER EXCHANGERS

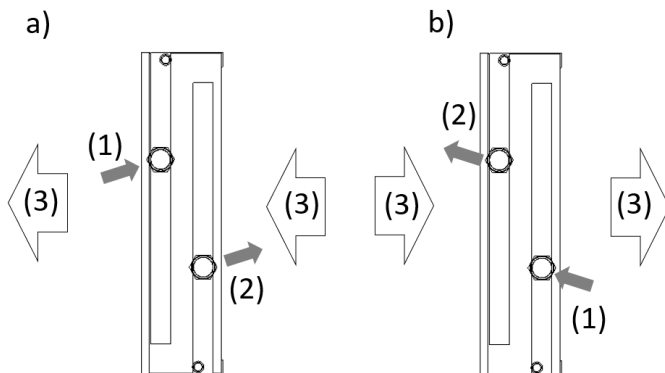

- a) Left-hand execution
- b) Right-hand execution
- (1) Heating/cooling medium supply to the exchanger
- (2) Return from the factor exchanger
- (3) Direction of air flow in the air handling unit

The exchanger's fluid supply and return connections should be configured so that the exchanger operates in countercurrent mode. The co-current mode of operation of the exchanger provides a lower average temperature difference, affecting its operating efficiency.

NOMINAL DIAMETERS OF CONNECTIONS DN [mm].	WATER EXCHANGERS	
	CONNECTION MATERIAL	METHOD OF COONNECTIONS
20	Brass	3/4" R-thread
25	Brass	R 1" thread
32	Brass	Thread 1 1/4"
50	Steel	2" thread
80	Steel	3" R-thread

5.2 CONNECTION OF DX EXCHANGERS (DIRECT EXPANSION)

- ! Connection of the DX exchanger must be carried out by a qualified refrigeration fitter in accordance with the rules and regulations in force for freon refrigeration appliances (F-gas qualification).
- ! The DX heat exchanger is designed for use with R410A or R32 refrigerant (not supplied) in a system with an expansion valve.
- ! To ensure proper operation of the DX coolers or heaters, these exchangers should be connected to the DX installation with the condensing/cooling unit in accordance with all applicable regulations, rules and best practices.
- ! Maximum operating pressure 42 bar (for 5/16" exchangers)
- ! Operation or standstill in sub-zero temperatures requires a protection system and a defrosting system. The coil should be protected against frost build-up on its surface
- ! The exchanger must not be allowed to FROST or frost over completely.
- ! For units equipped with a freon installation - check the applicable regulations relating to the obligations of the installer, owner (operator) of the heat pump or DX installation before installing the unit (see F-Gas Act).
- ! The refrigerant must not be released into the atmosphere! If the addition or extraction of refrigerant is required, then the service technician carrying out this operation must comply with all local regulations.
- ! The owner of the heat pump or the owner (operator) of the DX plant is required to set up a Product Card in which all inspections, repairs or modifications to the unit are recorded.

SUPPLY PRINCIPLE FOR DX EXCHANGERS (COOLERS, HEATERS)

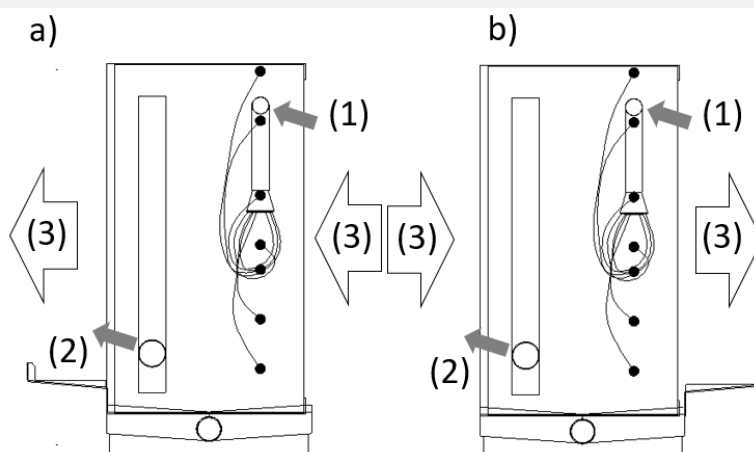

- a) Left-hand execution
- b) Right-hand execution
- (1) Exchanger feed (liquid line - medium supply to the manifold)
- (2) Suction line (vapour line - return of refrigerant to compressor)
- (3) Direction of air flow in the air handling unit

- ! DX heat exchangers have copper stubs suitable for brazing.
- ! DX heat exchangers have capillary connections. When brazing or welding pipes, avoid exposing pipe components to high temperatures when making capillary connections and protect the valve closest to the connection to be made with a wet cloth.

5.3 CONDENSATE DRAINAGE

Moisture can condense on the surfaces of the air coolers and heat recovery exchanger from the air. The condensed moisture (condensate) flows into the drip tray located below these functions. The installer must connect the drip trays to the drainage system, including the use of traps. Condensate drainage is led outside the air handling unit casing. The outlets are located in the condensate drip trays of the coolers (the diameter of the drain pipe is 32 mm).



- ! For proper operation of the air handling unit, it is required to install traps for the baths on the suction side of the fan (on vacuum).
- ! The use of siphons is recommended for baths located on the discharge side of the fan (at positive pressure).
- ! Ball valves cannot be used on the discharge side of the fan.
- ! It is not possible to combine different condensate drains into one trap.
- ! Fill the siphon with water before starting the air handling unit.
- ! If the environment is cold, insulate the drainage pipes.
- ! If the condensate is in danger of freezing, a suitable system for heating it must be used.

CONDENSATE DRAIN – U-TRAP (SIPHON) CONNECTION

$p < p$ atmospheric

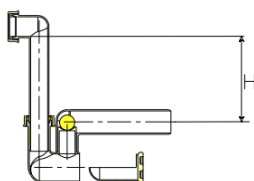

$p > p$ atmospheric

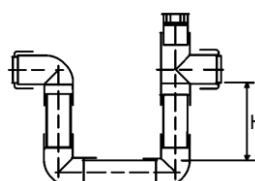

H [mm] = total fan discharge in mm H₂O

$$H \text{ [mm]} = Dp \text{ [Pa]} * 0.1$$

Dp [Pa] - fan discharge in pascals

6 ELECTRICAL CONNECTION TO THE CONTROL PANEL

6.1 ELECTRICAL CONNECTION

Supply and extract units with a hexagonal counter-flow heat recovery exchanger are factory-wired and equipped with advanced control and safety automation.

The connection box (electrical isolator) for the unit power supply is routed outside the AHU. The isolator is connected to a 4 m cable. The isolator must be installed and connected to the power supply on site.

The extract fan section contains the control cabinet and the power supply connection point for the main water heater pump. The control cabinet includes a dedicated terminal for connecting peripheral control components installed outside the AHU on site.

JUNCTION BOX (CONTROL SWITCHBOARD) IN A HEAT RECOVERY UNIT

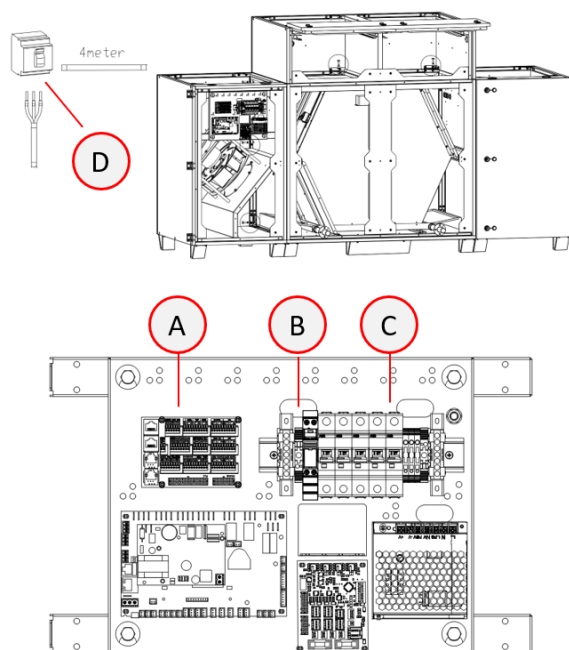

A - Terminal 1 (T1) - connection point for peripheral control components (signal cables for water valve actuators, duct sensors, etc.)

B - connection for the main water heater pump

C - overcurrent circuit breaker

D - AHU power supply connection and main switch



- ! The cross-sections and types of cable (e.g. shielded cable) supplying power to individual functional components should be selected based on the rated current and specific operating conditions (e.g. ambient temperature, wiring method, distance from power source).
- ! The electric heaters and water pumps for the pre- and post-heaters are to be supplied from an external switchgear (outside the scope of supply).
- ! Electric heaters are to be connected to individual junction boxes located in the heaters.



- ! AHUs without heat recovery require an external power and control switchgear and Control components to be installed, connected and configured on site.
- ! See instructions:
 - "Control gear for Supply and Supply-Exhaust Air Handling Units." / "Control gear for Supply and Supply-Exhaust Air Handling Units."

CONNECTING THE POWER SUPPLY TO THE HEAT RECOVERY SECTION (3~400V AC 50Hz)

AHU	Maximum number of fans up to 0.75 kW per section	Rated Current	Overcurrent protection	Power supply cable
[-]	[-]	[A]	[-]	[-]
VVS023c	x1	19	C20/3	5x 2,5mm ²
VVS023c	x2	19	C20/3	5x 2,5mm ²
VVS033c	x2	22	C20/3	5x 2,5mm ²
VVS033c	x3	19	C25/3	5x 4,0mm ²
VVS043c	x2	19	C20/3	5x 2,5mm ²
VVS043c	x3	22	C25/3	5x 4,0mm ²

The units are equipped with modern and efficient fans with EC motors. The IP degree of protection of the motors with the controller is 44. The motors' own electronics protect them from overloading and failure.

6.2 CONNECTION OF THE VERSION WITHOUT FACTORY WIRING



- ! Cable cross-sections and types (e.g. shielded cable) supplying individual functional components should be selected based on the rated current and specific operating conditions, such as ambient temperature, wiring method, and distance from the power supply source.
- ! EC motors are controlled by a Modbus RTU (RS485) signal. If control by a 0-10 V signal is required, a 0-10 V / Modbus RTU converter must be used.
- ! Fan motors are supplied with 1~230 V AC, 50 /60Hz.

MOLEX CONNECTING BRACKET EC MOTOR 0,75kW

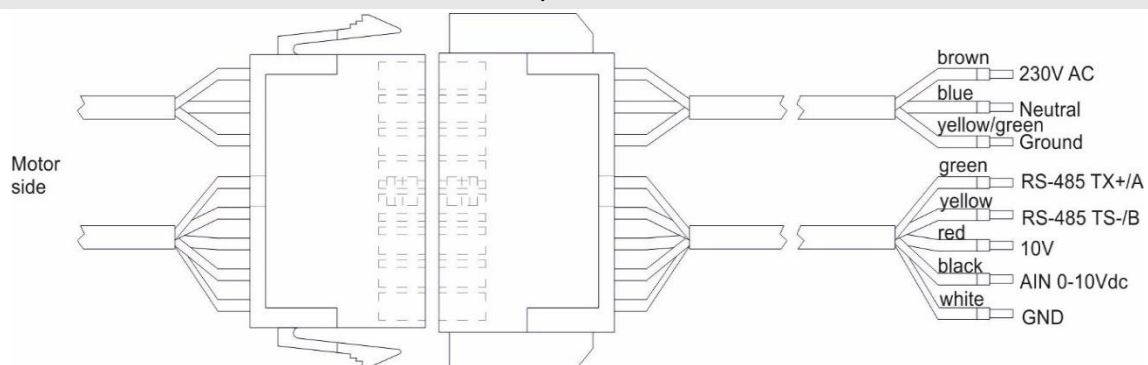

Colour coding: brown - 230V AC , blue - neutral , green/yellow - earthing
 green - RS485 TX+/A, yellow - RS485 TX-/B, red - 10V DC output, black - 0-10V DC AIN input,
 white - GND

7 ELECTRIC HEATER

7.1 GENERAL INFORMATION

The electric heater can be an optional accessory (separate section) or built into the base block of the air handling unit (VVS021c, VVS030c). If the heater is built into the base block, the heater is connected at the factory to the main supply point of the air handling unit.

The method of connecting the optional heater is described in separate documentation, which is available via the link provided in the QR code on the plate. Detailed information can also be found in the document "Electric heaters - slices Technical and operating documentation" on the manufacturer's website www.vtsgroup.com.

The heater consists of heating elements (heaters), a connection terminal, control Control (SCCR) and over-temperature protection.

The heaters are Cr-Ni-Fe heating wires of 6kW/400V. They are connected in heating slices (heating sections). The heater can consist of 1, 2 or 3 heating slices.

Electric heaters can be supplied in two power variants - low power to suit AHUs with relatively low heating requirements and high wattage, covering AHU cases for facilities with higher heating requirements. These types differ primarily in the types of electrical connection of the individual heaters in the heater unit (star connection for low power or delta connection for high power).

The appropriate connection of the heaters to each other is made at the heater manufacturing stage - the installer is only required to connect the power and control wires - no modifications to the heater system connections from the factory configuration are allowed.

DUCT INSULATION ELECTRIC HEATER - TO BE MADE ON SITE.



- ! Electric heaters are available in a ducted version (without thermal insulation and feet/frames) as well as a built-in version in the MW40 insulation casing.
- ! When insulating the ventilation ducts, which must include the housing of the electric heater, it must be ensured that the connection point (especially its ventilation openings) is outside the insulation layer.



See instructions at www.vtsgroup.com :

- ! Installation, Operation and Maintenance Manual - Electric Heater supply and control system/ Electric heater supply and control system Technical and operating documentation,
- ! Operation and Maintenance manual - Electric Heaters - Power Slices / Electric Heaters - Slices Technical and Operational Documentation.

The electric heater is an optional accessory and consists of heating elements (heaters), connection terminal, control Control (SCCR) and over-temperature protection.

The heaters are Cr-Ni-Fe heating wires of 6kW/400V. They are connected in heating slices (heating sections). The heater can consist of: 1, 2 or 3 heating slices.

Electric heaters can be supplied in two power variants - low power, which is suited to AHUs with relatively low heating requirements, and high power, which includes AHU cases for facilities with higher heat requirements. These types differ primarily in the types of electrical connection of the individual heaters in the heater unit (star connection for low power or delta connection for high power).

The appropriate connection of the heaters to each other is made at the heater manufacturing stage - the installer is only required to connect the power and control wires - no modifications to the heater system connections from the factory configuration are allowed.

MODULATING THE SUPPLY VOLTAGE DEPENDING ON THE HEATING POWER DEMAND (FIRST HEATING SLICE).



The first slice is controlled steplessly 0-10V, each remaining slice (ON/OFF) ON-OFF.

Each time a regulated slice reaches full output, the demand is passed on to the next slice, which starts operating at full capacity. Any additional heating power will be realised by steplessly increasing the regulated heating power of the modulating slice.

DETAILS OF THE ELECTRICAL INSTALLATION

Type of network	TN
Rated supply voltage	3x400V AC
Rated insulation voltage	400V
Rated withstand surge voltage	2500V
Rated short-circuit current I _{cw} for individual circuits - effective value of the periodic component withstanding for 1s, i.e. the short-circuit current expected at the switching voltage	6kA
Rated short-circuit current	6kA
Simultaneity factor	0,8
Rated frequency	50 Hz
Degree of protection	IP00
Permissible operating temperature	0 °C ÷ (+50) °C
Supply voltage of control circuits	24V DC
Type of network	TN
Rated supply voltage	3~400V AC
Rated insulation voltage	400V
Rated withstand surge voltage	2500V

7.2 HEATER POWER CONNECTION AND CURRENT PROTECTION



- ! The power supply connection must be made using a separate switchboard, which is not supplied by VTS.
- ! The heater connection should be made in such a way that the heater cannot be switched on when the fan is not switched on - this is ensured by factory-fitted, series-connected safety devices in the form of a thermostat and pressure switch, which prevent the heater from being switched on if the temperature and air flow conditions are not met.
- ! If the fan stops, it is essential to switch off the power supply to the heater.

The type of conductors used for the various heater functions is shown in the table below. The conductor cross-section and its protection should be selected based on the information indicated in the table above.

TYPES OF CABLES FOR CONNECTING ELECTRIC HEATERS			
Application of the cable	Rated voltage	Type	Operating temperature
Power supply for electric heaters	3~400V AC	multi-stranded, stranded copper wire	(-30) C°÷ (+60) C°
Power supply for the control system	1~230V AC	multi-stranded, stranded copper wire	(-30) C°÷ (+60) C°
Control of the heater Control system	24V DC	multi-stranded, stranded copper wire	(-30) C°÷ (+60) C°

EXAMPLE OF CONNECTING AN ELECTRIC HEATER WITH A 1x18kW UNIT

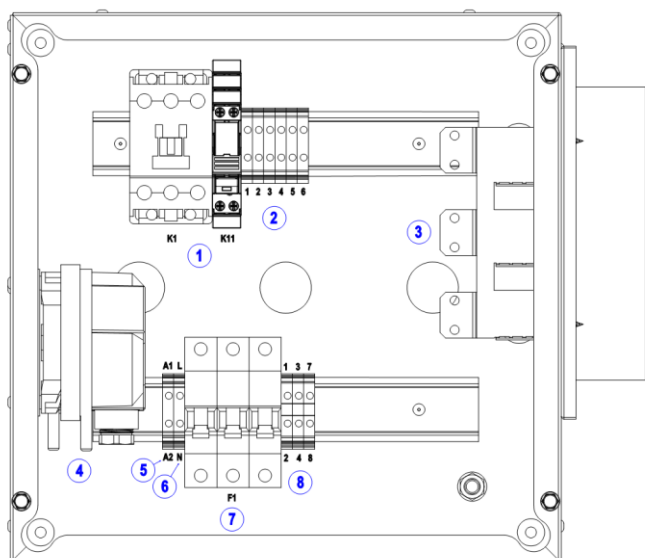

Designation	Description	Connection	Comments
1	relays / contactors	factory	-
2	heater terminals	factory	-
3	heaters	factory	-
4	pressure switch	factory / <u>installer</u>	<u>the connection of the pressure switch tubes is made by the user</u>
5	signal terminals - alarm	<u>on site / installer</u>	-
6	power terminals 1f	<u>on site / installer</u>	-
7	overcurrent circuit breakers	<u>on site / installer</u>	-
8	signal terminals - control	<u>on site / installer</u>	-

The switchgear views shown are intended to illustrate the arrangement of components inside the switchgear enclosure. Please note that they are for illustrative purposes only - when making electrical connections, always refer to the electrical diagrams.

CONNECTION OF ELECTRIC HEATER WITH 4X18KW SWITCHBOARD

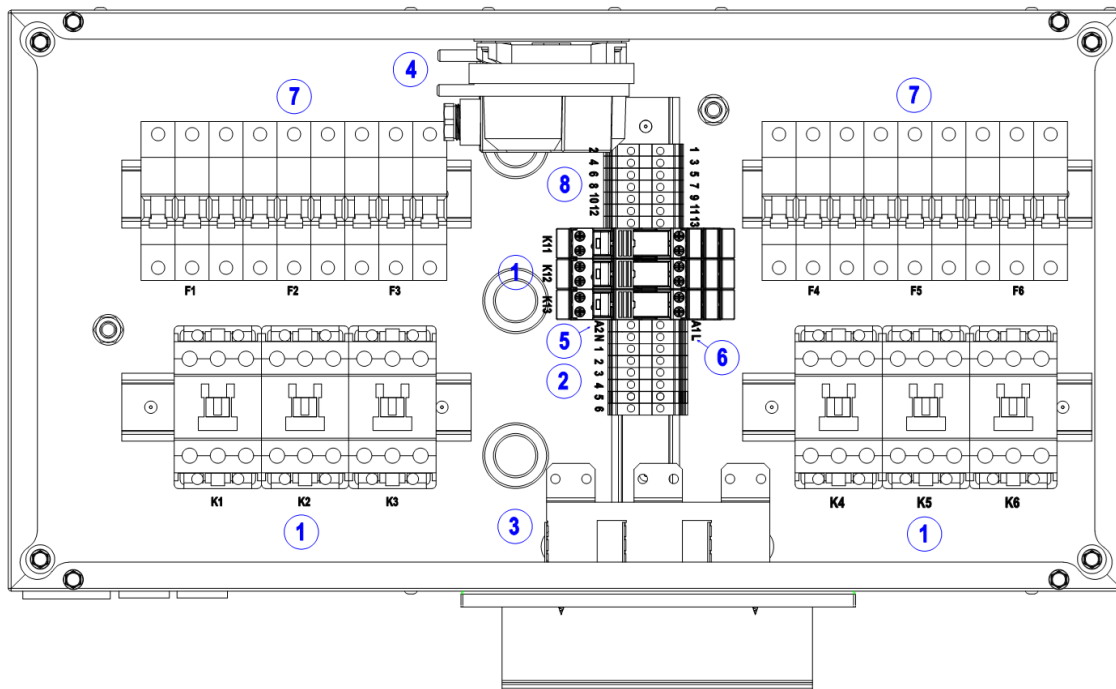

P.	DESCRIPTION	CONNECTION	COMMENTS
1	relays / contactors	factory	-
2	heater terminals	factory	-
3	heaters	factory	-
4	pressure switch	factory / <u>installer</u>	<u>the connection of the pressure switch tubes is made by the user</u>
5	signal terminals - alarm	<u>on site / installer</u>	-
6	power terminals 1f	<u>on site / installer</u>	-
7	overcurrent circuit breakers	<u>on site / installer</u>	-
8	signal terminals - control	<u>on site / installer</u>	-

The switchgear views shown are intended to illustrate the arrangement of components inside the switchgear enclosure. Please note that they are for illustrative purposes only - when making electrical connections, always refer to the electrical diagrams.

7.3 THERMAL CUT-OUT (THERMIC)

The functionality of the thermostat is based on the properties of the bimetallic element - it causes the contacts of the heater control circuit to open when the air temperature near the thermostat is 65°C. After an emergency shutdown, the heater automatically switches on when the air temperature drops by 20°C. After a deliberate or emergency (due to overheating) power off, the supply fan must run for some time (0.5-5 min) so that the heaters reach normal temperature.



! The thermal switch is an integrated, factory-fitted component of each heater patch - no additional installation or electrical connection by the installer is required.

THERMAL CUT-OUT - CHARACTERISTICS

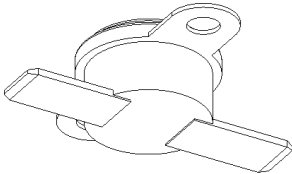
THERMAL BREAKER	CONNECT	COMMENTS
	Function	heater overheating protection (temperature control of heating elements)
	Construction	<ul style="list-style-type: none"> metal housing two screw terminals bimetallic element with NC contact function
	Rated operating voltage	30V DC
	Output signal type	potential-free (changeover contact)
	Activation temperature	(+65) °C
	Temperature hysteresis	17 °C

7.4 DIFFERENTIAL PRESSURE SWITCH

The differential pressure switch is another safety element, in addition to the thermostat, which prevents the heater from operating under unallowable conditions. It prevents the heater from switching on if the pressure generated by the fan units on the supply side of the air handling unit is insufficient to ensure safe operation of the heating elements.



! The pressure switch is a factory fitted and electrically connected component - **the connection of the pressure switch pressure hoses must be made on site according to the following instructions:**

- one of the conductors should be routed to atmospheric pressure - if the switchboard is installed on a duct (outside), the cable does not need to be connected - there is atmospheric pressure in the switchboard,
- the second of the hoses should be connected to the positive or negative pressure in the air handling unit or duct (before or after the supply motor),
- it is permissible to relocate the pressure switch outside the switchboard (in the duct version of the heater) in order to avoid the need to run long measuring tubes - the recommended position of the pressure switch is horizontal, in the vertical position the reading is 11Pa higher than the actual one.



! The switching threshold of the pressure switch is 20 Pa. When connected to the AHU, check that the pressure switch is operating correctly for the smallest available capacity of the air handling unit. **If no differential pressure is detected**, change the connection point of the second pressure hose to the system.

! In the opposite case - **when for a given pressure switch setting the pressure difference is detected even if the unit is switched off** (allowing the heater to operate **even if the fans are not running**), the setting should be gradually increased until correct operation is obtained - it is indicated by the electric heater not operating despite the occurrence of control signals, if the pressure switch does not detect the pressure difference between the measurement channels - permission should be given only after the fans are started up.

! **Once the pressure switch is fully connected, the heater shutdown test must be performed.** To do so, force the electric heater control manually (e.g. by providing control signals for the heater from the controller) and at the same time stop controlling the fans. The pressure switch should prevent the electric heater from operating (this will be visible e.g. by disconnecting the contactors in the switchgear).

DIFFERENTIAL PRESSURE SWITCH - CHARACTERISTICS

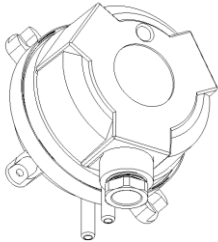
DIFFERENTIAL PRESSURE SWITCH	CONNECT	NOTES
	Function	protection of the heater against overheating (control of pressure difference between supply air and atmospheric pressure)
	Construction	<ul style="list-style-type: none"> plastic housing, two screw terminals, diaphragm connected to mechanical module
	Rated operating voltage	30 V DC
	Output signal type	potential-free (changeover contact)
	Measuring range	20-300 Pa

7.5 CONNECTION OF ELECTRIC HEATER CONTROL

ELECTRIC HEATER CONNECTION CABLE MARKING - PLUG&PLAY CONTROL

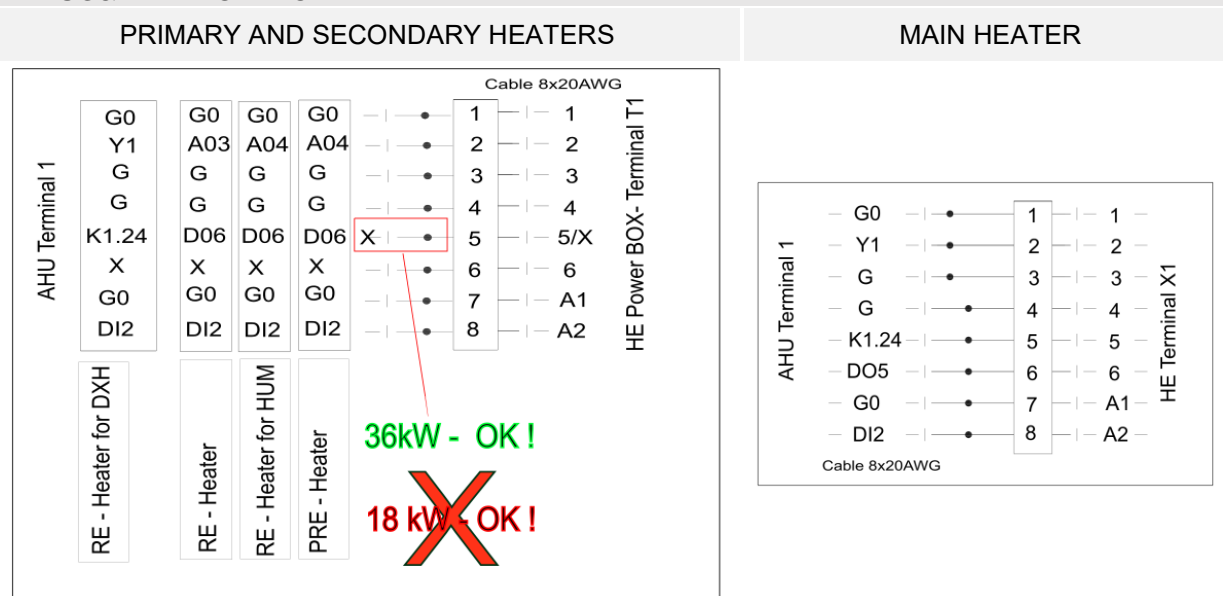

5/x - connect only up to 36kW

AHU Terminal 1 - Connection terminal "Terminal 1" in the panel box/distribution panel.

HE Power BOX - Connection terminal X1 in the electrical heater box/distribution panel.

RE-Heater - Secondary heater for a case other than the following.

RE-Heater DXH - Secondary heater for heat pump unit (C_dhx).

RE-Heater for HUM - Secondary heater for the humidifier unit.

PRE-Heater - Pre-heater.

K1.24 - the connection should be made to pin 24 of the pump relay (K1) located in the control panel of the AHU

8 PLUG&PLAY CONTROL COMPONENTS

The *VENTUS COMPACT* base unit with heat recovery (counter-flow hexagonal exchanger or rotary exchanger), fans and air filters is supplied as a pre-wired unit with the configured Control system connected. The Control system is based on the factory-programmed and built-in uPC3 controller.

Peripheral Control components whose specifics require installation outside the base unit (room or duct mounted sensors, actuators, valves) are supplied in separate packages. It is necessary to connect them on site according to the installation and connection instructions.

LABELLING OF PLUG&PLAY CONTROL COMPONENTS

Control components requiring connection on site are equipped with connection cables that include a label with the method of connection to Terminal 1.

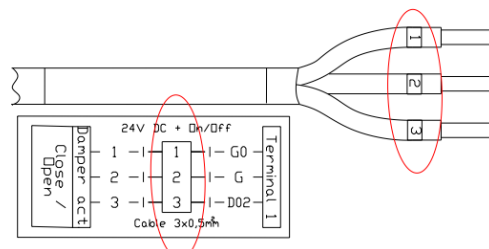

8.1 STANDARD EQUIPMENT WITH FACTORY-FITTED CONTROL ELEMENTS

STANDARD CONTROL COMPONENTS - ASSEMBLY AND CONNECTION AT THE FACTORY		
Designation	Name	Location
	uPC3 controller	Control switchgear
	Terminal 1 (T1)	Connection terminal for peripheral Control components
	Security	Control switchgear (according to the diagram)
B2	Temperature sensor	Return air from the room (extract before recovery)
H2	Moisture sensor	Return air from the room (extract before recovery)
B4	Temperature sensor	Exhaust air (exhaust after recovery)
B6	Temperature sensor	Supply air (for recovery)
B3	Temperature sensor	Outside air (before recovery)
	Differential pressure sensor	Supply air (pre-filter)
	Differential pressure sensor	Supply air (fan)
	Differential pressure sensor	Exhaust air (pre-filter)
	Differential pressure sensor	Exhaust air (fan)

The sensors are mounted in the heat recovery section.

8.2 CONNECTION TERMINAL 1 (T1)

Terminal 1 (T1) is connected at the factory to the uPC3 controller and is a dedicated terminal for the connection of peripheral Control elements that exist outside the base unit of the unit and therefore could not be connected at the factory. Additional Control elements outside the VTS range can also be connected to Terminal 1 (T1). Terminal 1 is located in the Control switchgear.

CONNECTION TERMINAL 1 (T1)

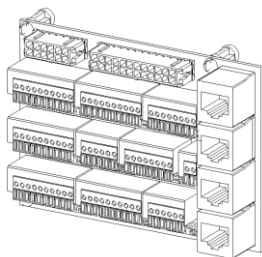

- A** - Terminal 1 (T1) - place for connecting peripheral Control elements (signal of water valve actuators, duct sensors, etc.).
- B** - connection of the water pump of the main heater.
- C** - Panel power connection and main switch.

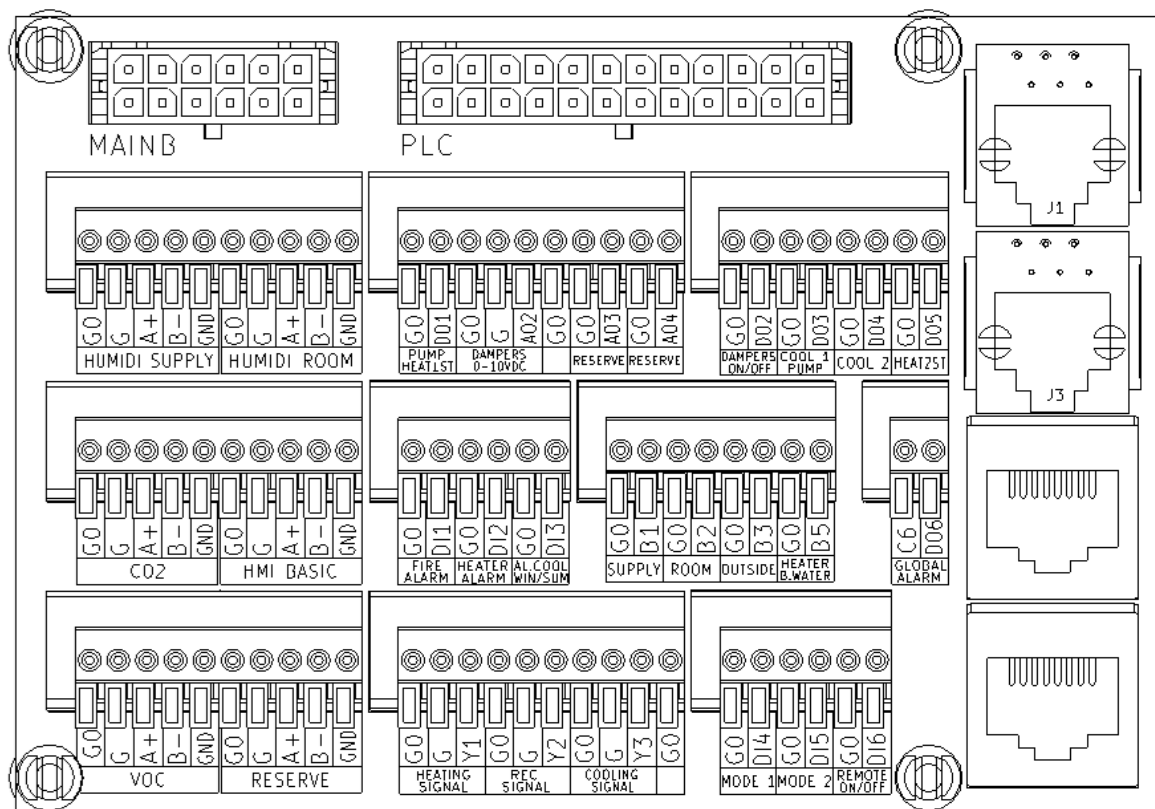

Terminal 1 (T1) has universal function designations. In some configurations, the contact designations may conflict with the connection instructions. In this case, the connection instructions are valid.

8.3 CABLE STANDARDS

APPLICATION	TYPE WIRED	WIRING [mm]
Fire alarm relay	[2]	2x0,75
Multifunction switch	[2]	2x0,75
Optional multifunction switch	[2]	2x0,75
Supply air temperature sensor	[1]	2x0,75
Room/extract air temperature sensor	[1]	2x0,75
Return water temperature sensor for water heater	[1]	2x0,75
Electric heater (HE) alarm relay	[2]	2x0,75
Air-side antiFROST thermostat to protect the water heater from freezing	[2]	2x0,75
Analogue controlled water heater valve	[1]	3x0,75
Electric heater power control input	[1]	3x0,75
Water heater circulation pump contactor		3x1,5
Alarm relay for refrigerator/cooling unit/heating pump	[2]	2x0,75
Refrigerator start-up input	[2]	2x0,75
Chiller start-up input - stage I	[2]	2x0,75
Chiller start-up input - stage II	[2]	2x0,75
Recirculation throttle actuator	[1]	3x0,75
Bypass actuator for the cross-flow exchanger	[1]	3x0,75
HMI Basic UPC control panel - interface with limited functionality	[3]	UTP 1x2
HMI Advanced UPC control panel - full-function interface	[4]	8x0,1

ID	TYPE WIRED	DESCRIPTION
[1]	Cables for the transmission of control signals - screened copper wires. PVC insulation.	Rated voltage 300/500 V. Ambient temperature: 30 °C to 80 °C.
[2]	Copper conductors PVC insulation	Rated voltage 450/750V. Ambient temperature: -40 to 70 °C
[3]	Copper conductors PVC insulation	Rated voltage 150 V. Ambient temperature: - 20...60°C
[4]	Unshielded flat data cables.	Rated voltage 150 V. Ambient temperature: - 20...60°C

8.4 ANALOGUE INPUTS (NTC10K)

ANALOGUE INPUTS (NTC10K)

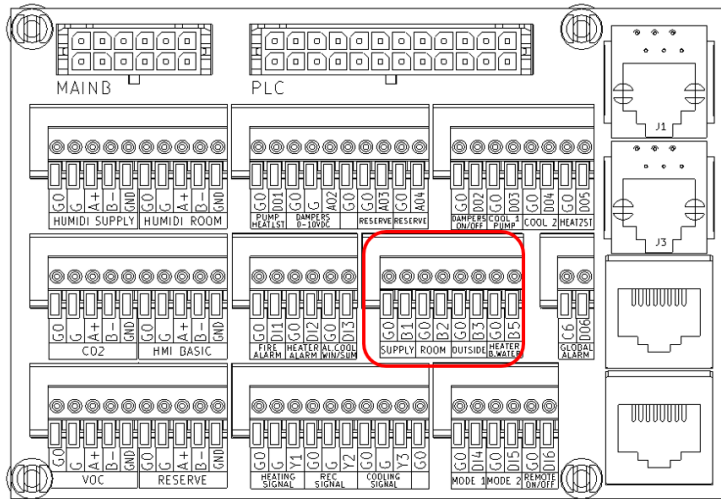

- B1 Duct temperature sensor - supply air
- B2* Temperature sensor - exhaust air
- B2/6 Duct sensor behind the pre-heater
- B3** Temperature sensor - outside air
- B5*** Touchscreen water heater temperature sensor.

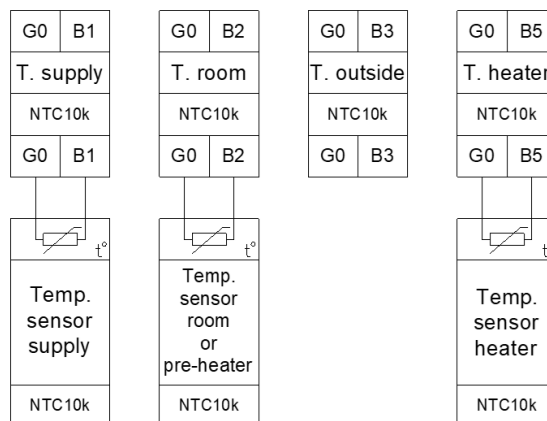

- **B2*** - Exhaust air temperature sensor which is factory fitted at the heat recovery. If a room sensor is used as the lead sensor (other than HMI BASIC), this sensor must be connected to B2 on terminal 1 T1
- **B3**** - Factory connections are made outside the T1 terminal directly at the uPC3 controller
- **B5***** - Touch sensor for water heater temperature which is assigned to one heater only (pre- or main heater). Priority of use is given to the pre-heater.

8.4.1 SUPPLY AIR TEMPERATURE SENSOR B1

SUPPLY AIR TEMPERATURE SENSOR B1

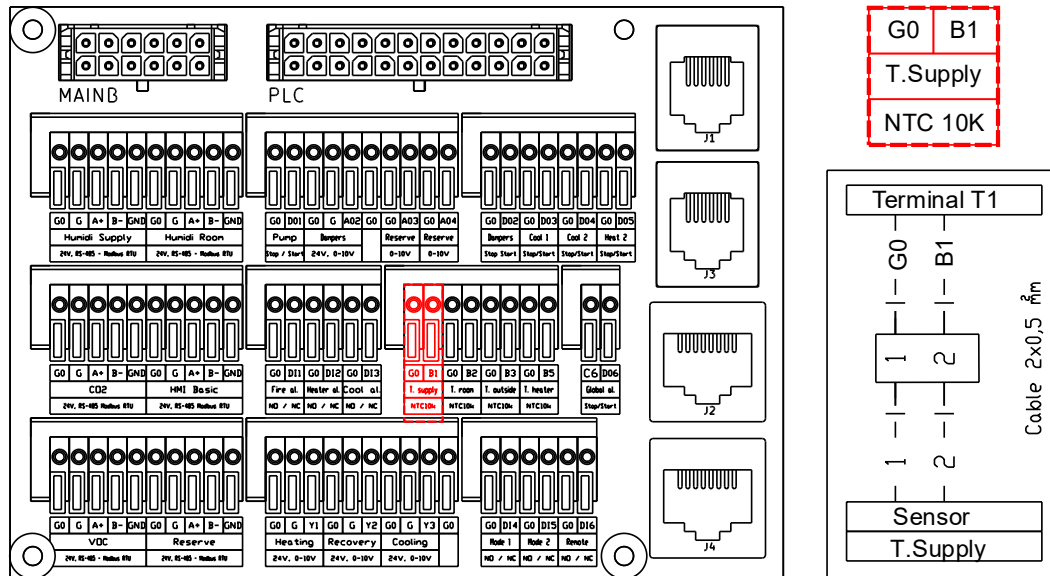

The sensor should be placed in the supply air duct after the last function that changes the air temperature in a stabilised and homogeneous air stream with a uniform temperature distribution.

The sensor should be placed in the supply air duct after the last section of the unit, in a place representative for temperature measurement (in a uniform air stream with an even temperature distribution). The minimum distance between the air outlet of the device section and the sensor should not be less than the distance defined as $1.5 \times$ the diagonal of the rectangular connection.

8.4.2 TOUCHSCREEN WATER HEATER TEMPERATURE SENSOR B5

TOUCHSCREEN WATER HEATER TEMPERATURE SENSOR B5

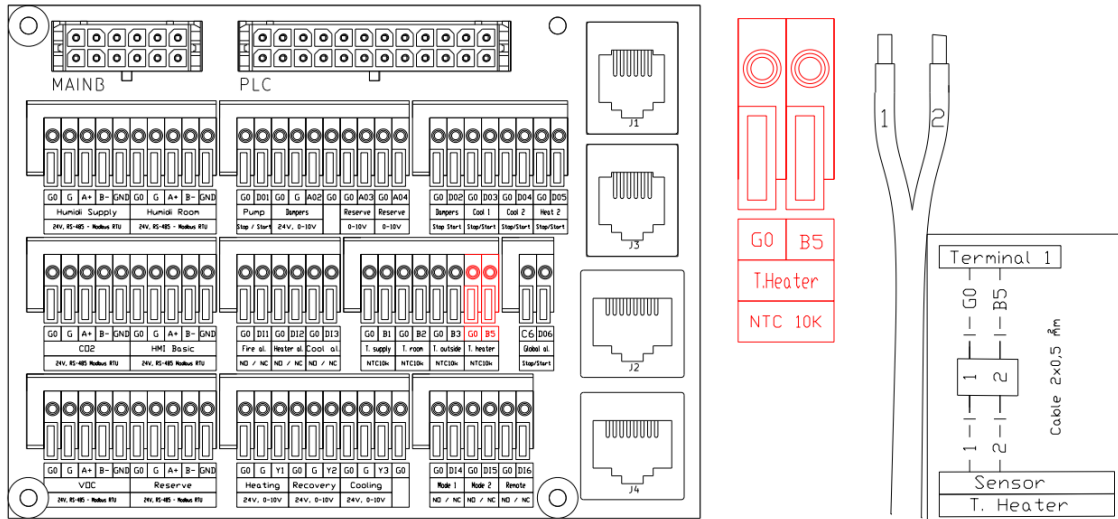

8.5 DIGITAL INPUTS

DIGITAL INPUTS

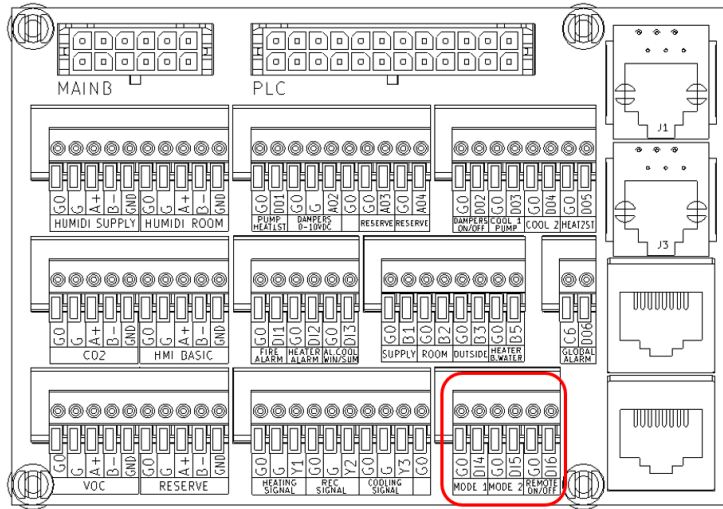

DI1	Fire alarm
DI2*	Heater alarm (freezing)
	Radiator alarm
DI3	Humidifier alarm
DI4	Cold source alarm
DI5	Programmable external input (enabling the panel or overriding the selected operating mode)
Remote	

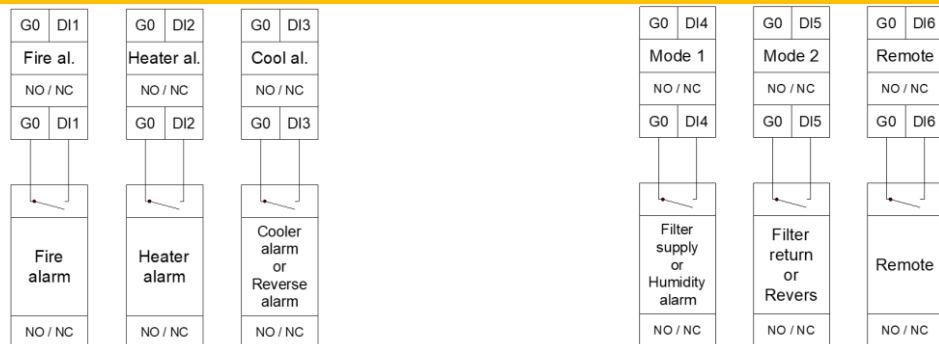

DI2* - Heater alarm (freezing). If there is no water heater and an electric heater is present, the alarm signal is used for the electric heater operation confirmation signal (A1/A2).

8.5.1 FIRE ALARM SIGNAL DI1

FIRE ALARM SIGNAL DI1

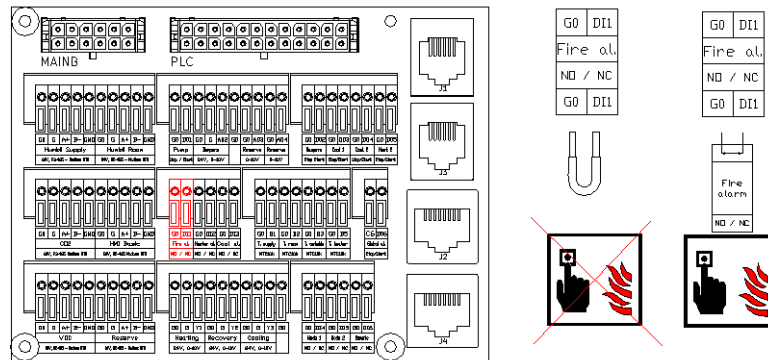

8.5.2 WATER HEATER FROST SENSOR DI2

WATER HEATER FROST SENSOR DI2

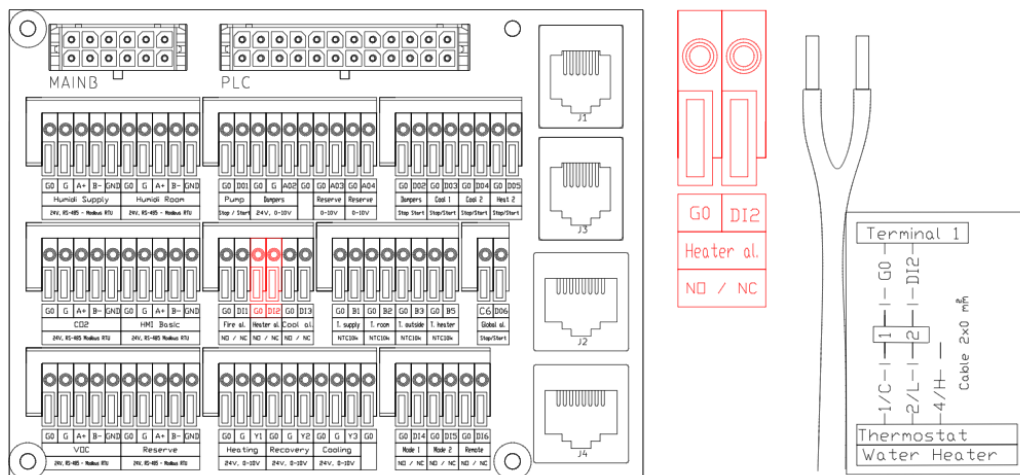

8.5.3 COLD SOURCE ALARM DI3

COLD SOURCE ALARM

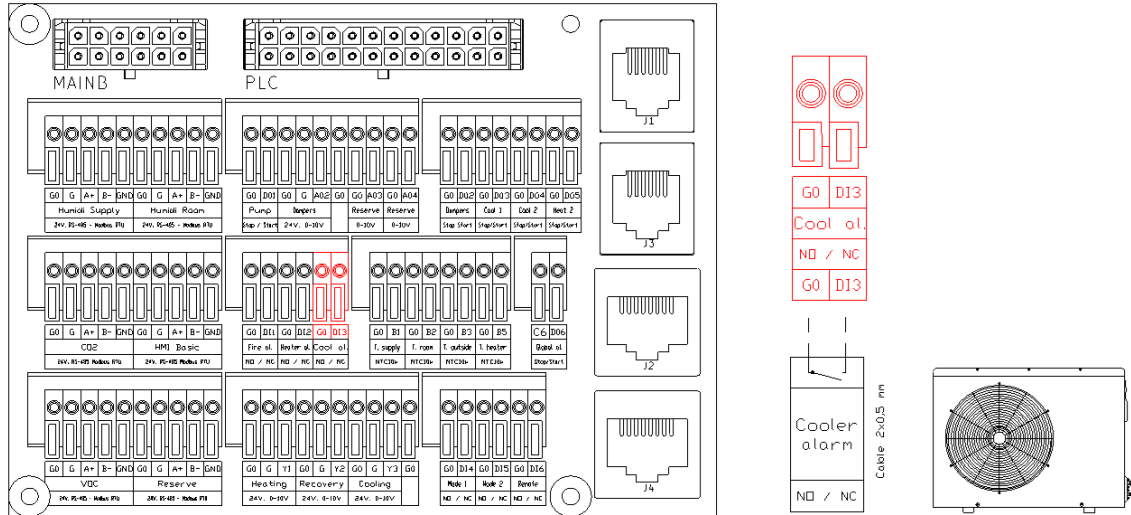

8.6 ANALOGUE OUTPUTS (0-10V DC)

ANALOGUE OUTPUTS (NTC10K)

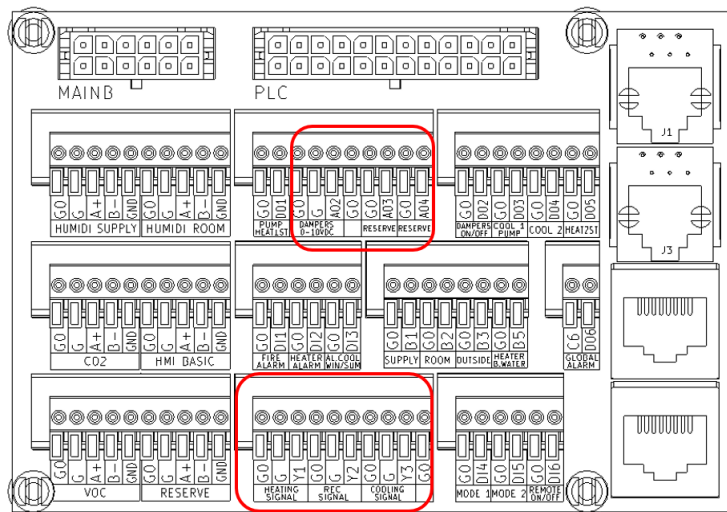

AO1*	Heat recovery
AO2	Air mixing
AO3	Humidification or secondary heater
AO4	Pre- or post-heater
Y1**	Main heater or secondary heater behind DX-H or mixing chamber
Y3***	Aftercooler or after-heater after DX-H or mixing chamber

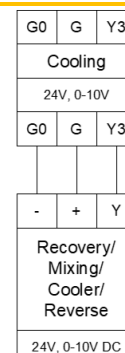
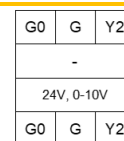
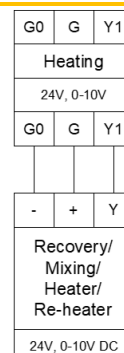
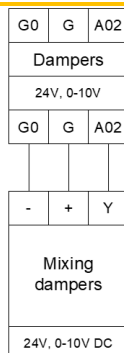

- **A01*** - factory connection outside terminal 1 (T1)
- **Y1**** - Priority: 1. main heater, 2. secondary heater for heat pump (DX-H), 3. Mixing chamber,
- **Y3***** Priority: 1. Refrigerator, 2. Heat pump secondary heater (DX-H), 3. Mixing chamber,

8.6.1 VALVE ACTUATOR OF THE WATER MAIN HEATER AND CONTROL SIGNAL OF THE ELECTRIC MAIN HEATER Y1

MAIN WATER HEATER Y1

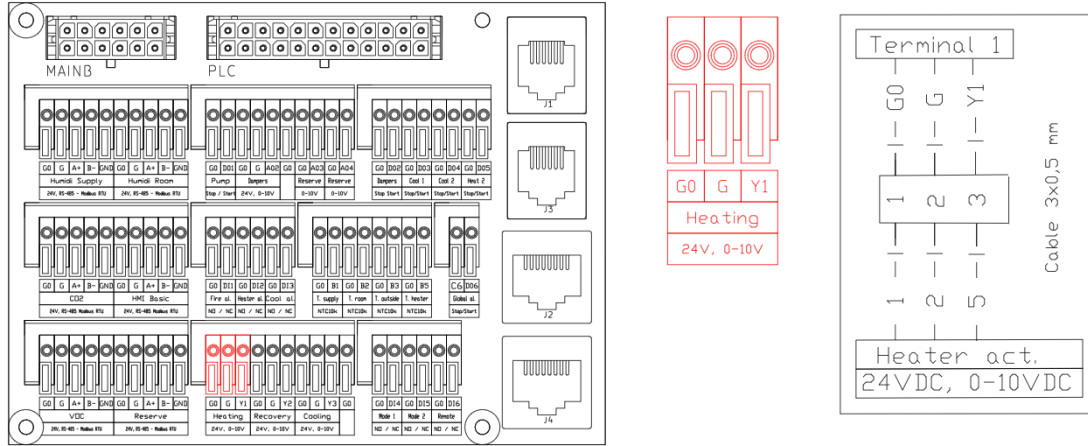

For the water heater, the control is connected to the valve actuator

8.6.2 VALVE ACTUATOR FOR WATER PRE- OR RE-HEATER AFTER DX-H Y1

WATER PRE- OR POST-HEATER BEHIND DX-H Y1

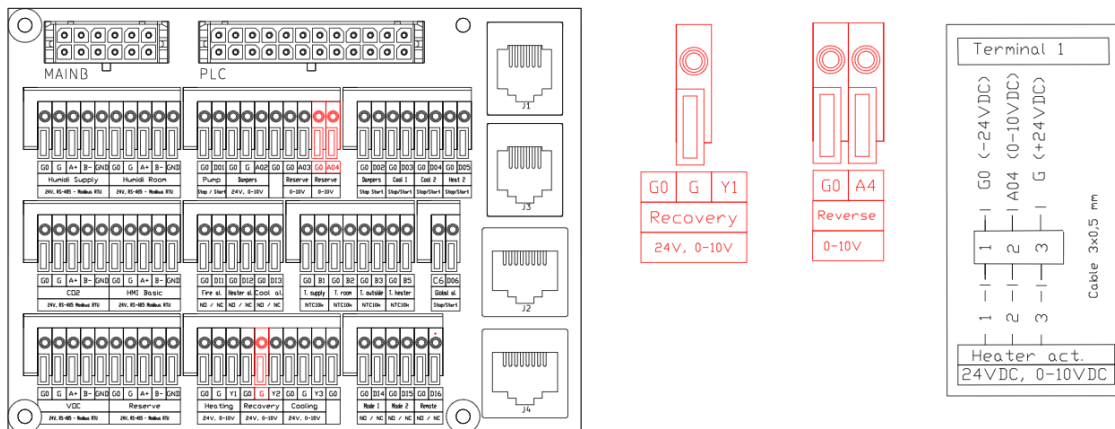

For the water heater, the control is connected to the valve actuator

8.7 DIGITAL OUTPUTS (24V DC)

DIGITAL OUTPUTS (24V DC)

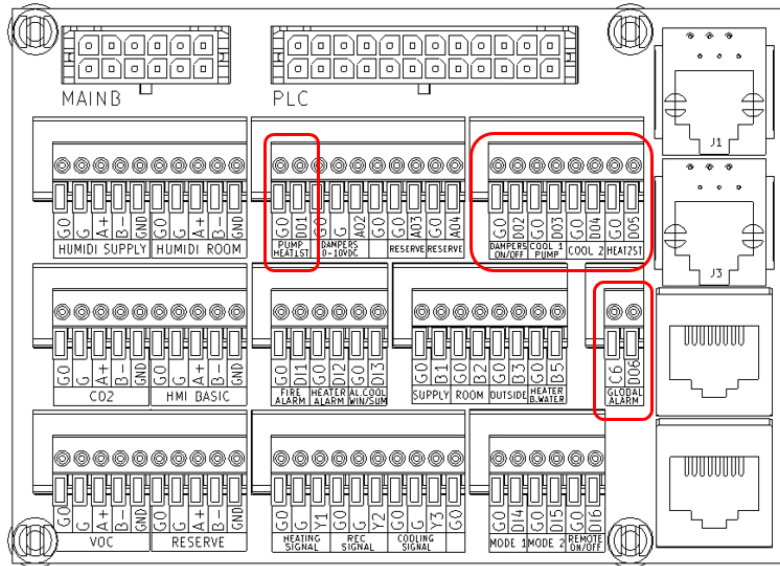

- D01 Main heater (or secondary heater if DX-H)
- D02 Air inlet and outlet passes
- D03 Radiator stage 1 or DX-H signal
- D04 Stage 2 cooler or stage 1 DX-H or humidifier or glycol recovery or redundant dampers
- D04 Heater stage 2 or DX-H stage 2
- D06 Pre-heater or secondary heater or general alarm

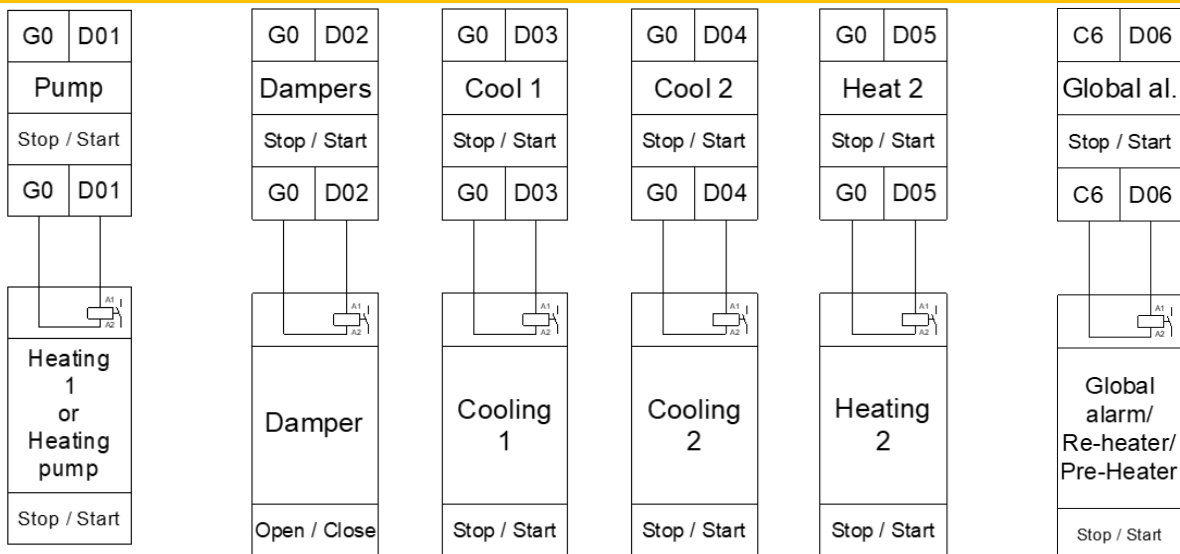

If 230V AC or potential-free contacts are required for the output signals, an isolating relay with a coil supplied at 24V DC from the controller's relay outputs must be used.

8.8 CONNECTION OF CONDENSING UNIT SIGNALS

DX EXCHANGER (0-10V CONTROL)

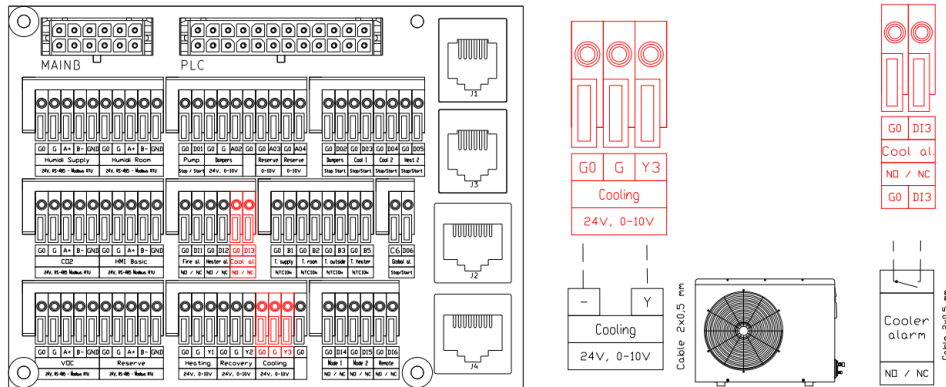

DX EXCHANGER (ON-OFF CONTROL)

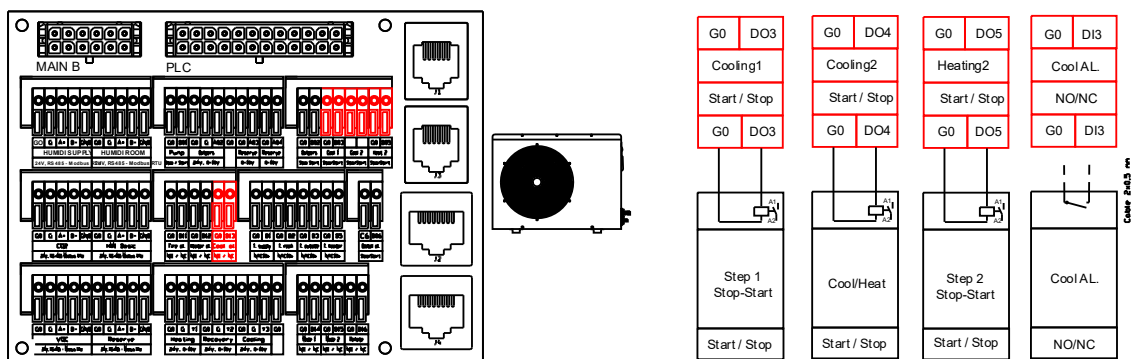

8.9 CONNECTION OF THREE-WAY VALVES

HEATER VALVE CONNECTION

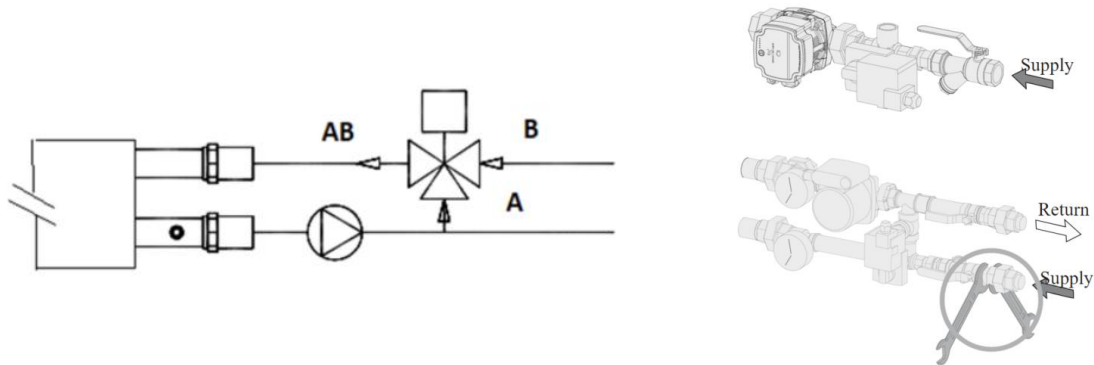

COOLER VALVE CONNECTION

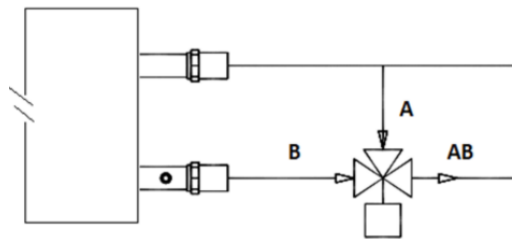

8.10 CONNECTION OF AIR DAMPER ACTUATORS

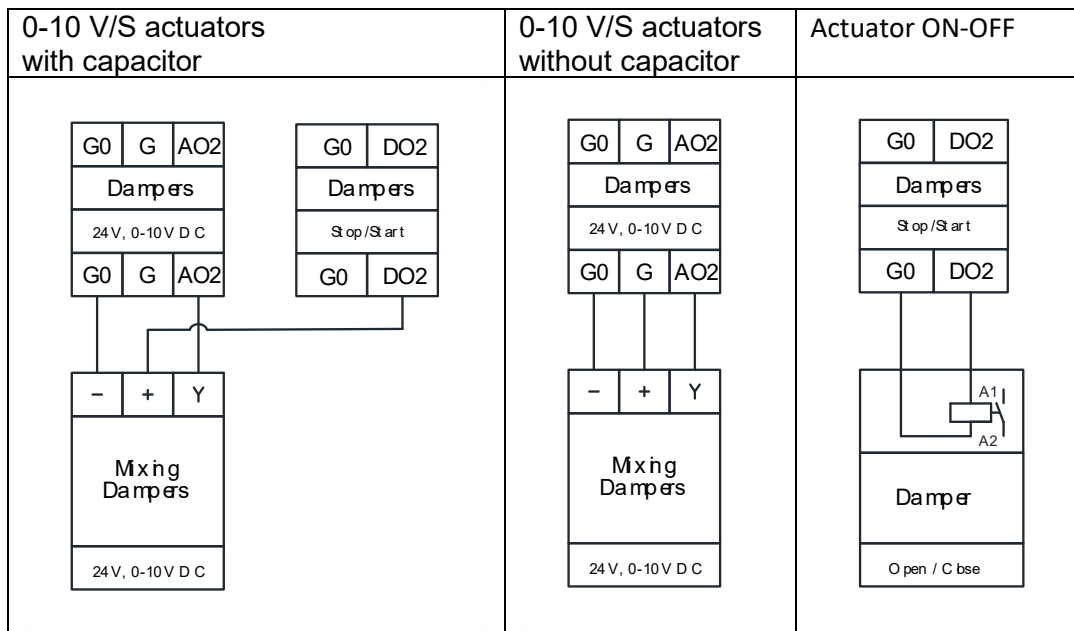

8.11 MODBUS RTU RS485 COMMUNICATION

MODBUS RTU RS485 COMMUNICATION

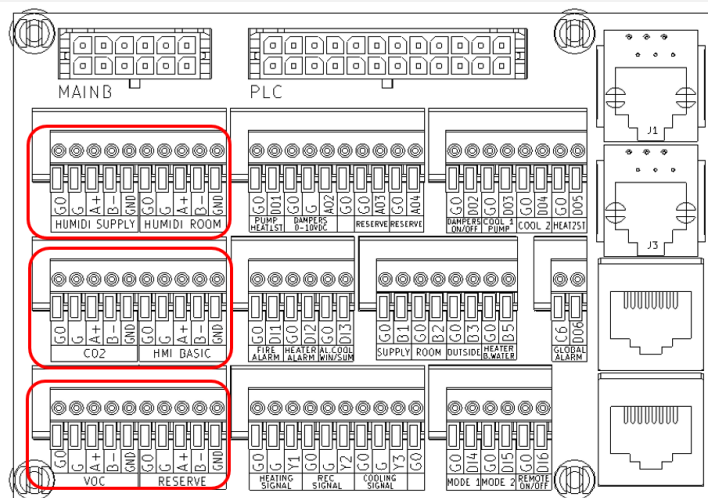

Humidity sensor - air supply

Humidity sensor - room (extract air)*

HMI Basic

CO2 sensor

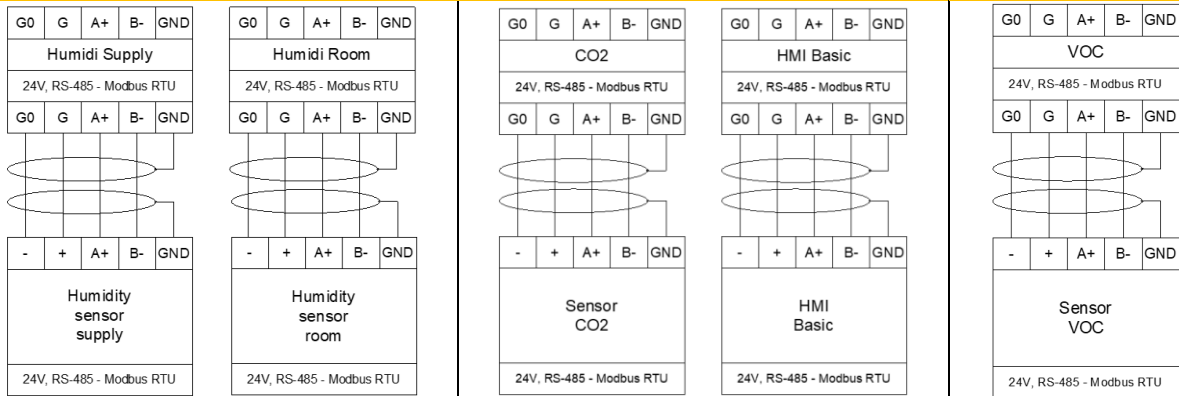

- Factory assembly

8.12 CONNECTION OF OPERATOR PANELS

8.12.1 HMI ADVANCED

HMI ADVANCED

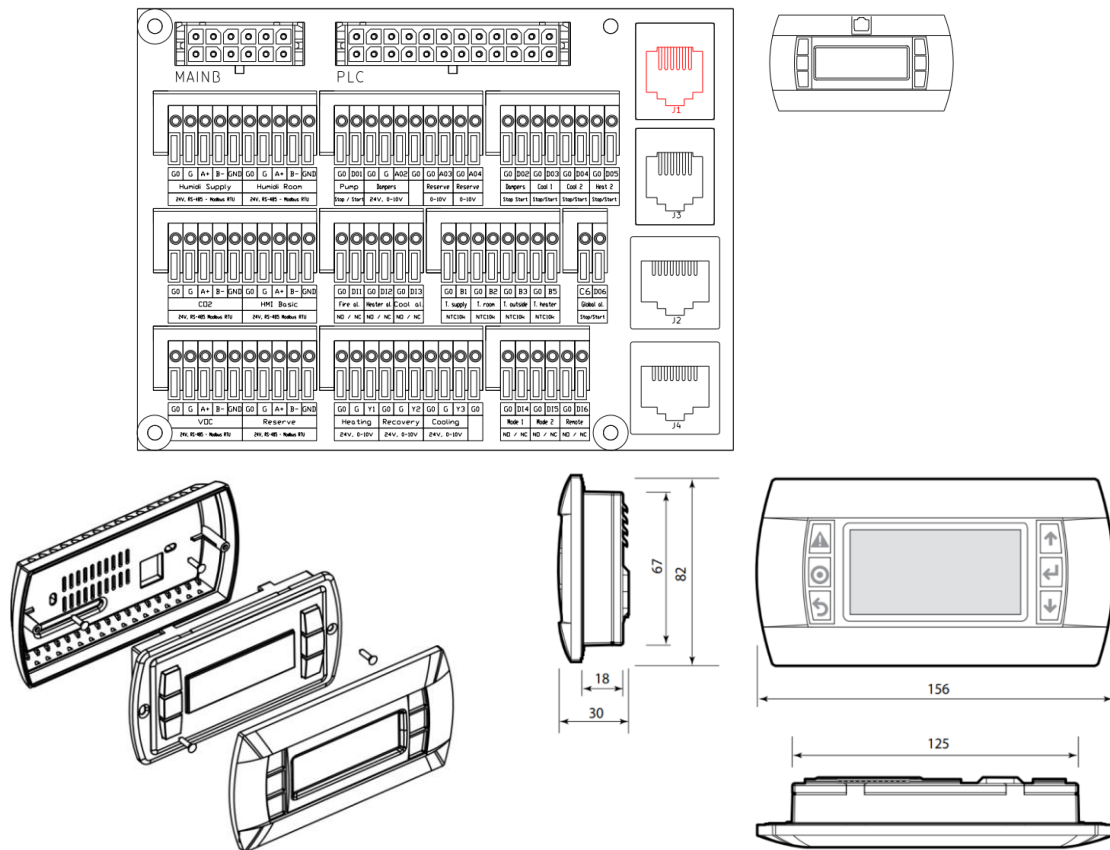

8.12.2 HMI BASIC (2HY)

HMI BASIC 2HY

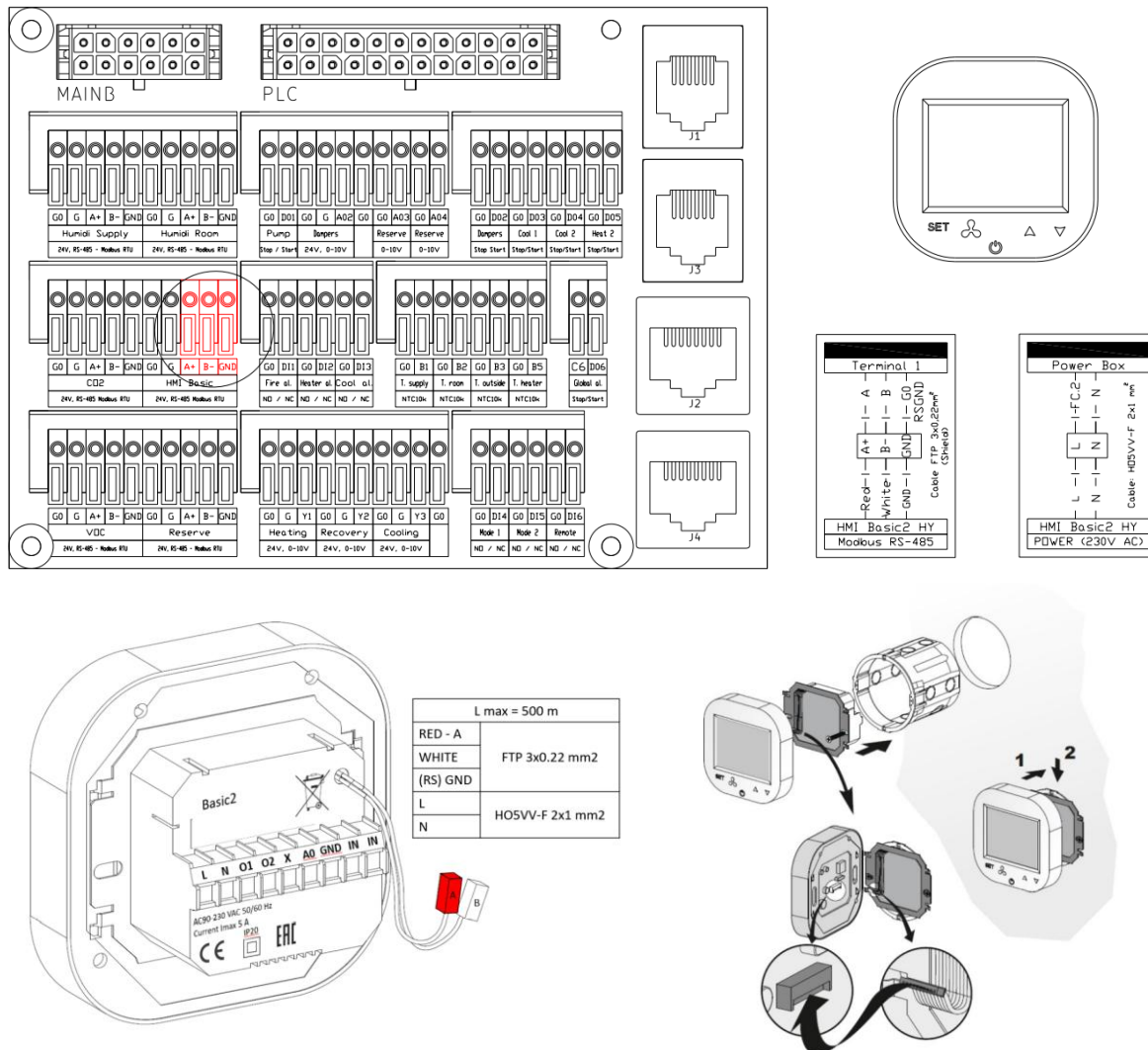

HMI connections are powered by 110-230V AC mains voltage. To ensure correct operation, separate power and control cables must be used, not exceeding the recommended length of 500m. The following cable types are recommended:

- supply: H05VV-F 2x1 mm²
- communication: FTP 3x0.22 mm²

8.12.3 WebHMI and VMS

VENTUS MANAGEMENT SYSTEM



VMS - Ventus Management System -
visualisation of panel operation with WebHMI function

<http://192.168.1.111>

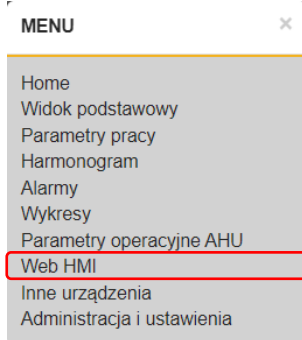

service



service

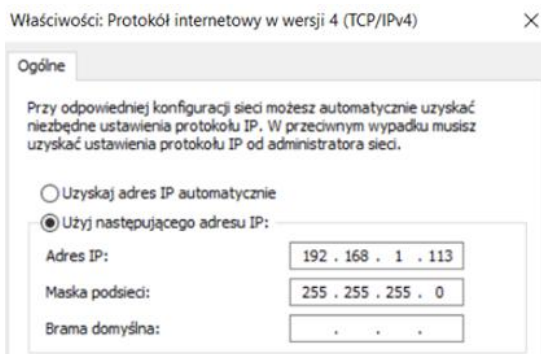

A fixed address is required to connect the controller IP: **192.168.1.xxx**, where xxx is different from 111. Subnet mask **255.255.255.0**

8.12.4 mHMI APPLICATION - BLUETOOTH DEVICE PAIRING

See chapter "BLUETOOTH MODULE AND mHMI APPLICATION".

9 FIRST START-UP

9.1 PREPARATION FOR THE FIRST START-UP



- ! **THE UNIT IS FACTORY-CONFIGURED TO START AUTOMATICALLY WHEN THE POWER SUPPLY IS CONNECTED FOR THE FIRST TIME.**
- ! Before proceeding with the activities leading to the first start-up, read the operating instructions for the operator panels.
- ! The air handling unit may only be operated with the filters installed.
- ! Replace the air filters with clean ones after the first few hours of operation.
- ! In this manual, the mask graphics of the HMI ADVANCED operator panel are used. The masks in other panels may differ slightly from those shown in the manual.

9.1.1 CHECKING THE CONDITION OF THE INSTALLATION

PRE-LAUNCH ACTIVITIES

Correct application of the device	As part of the commissioning procedure, it must be checked that the air conditioning/ventilating/heating unit in question has been constructed and installed in accordance with the structural/installation design and the manufacturer's guidelines.
Completeness of installation	Verify the presence of all AHU features and accessories (filters, dampers, actuators, valves, heaters/coolers, etc.) against the technical sheet - a full list of AHU components can be found in the technical sheet of the AHU, as well as on the labels of the individual delivery packages.
Connection to air ducts	Check that all ventilation equipment and components have been mechanically fitted and connected to the duct system.
Condition of air ducts	Check that the ducts are clean and the controls on the ducts are pre-adjusted.
Quality of installation on site	Check that the functional systems and components of the equipment have not been damaged during assembly or other operations, as well as Control components,
Connection of external sources of cooling and process heat	Check that the hydraulic systems and the freon installation are complete and ready and ready for operation and that the correct amount of heating or cooling medium has been introduced to start up the unit.

OPERATIONS BEFORE STARTING UP (cont'd)

Grounding system	Check that earthing cables are in place, connecting the control systems to the ventilation ducts.
Condensate system	Check that the condensate traps and drainage systems from the condensate gutter are fitted.
Control peripherals	Check the connections of the peripheral devices (T1 terminal) - as the optional equipment of the control panel, such as operator panels and some temperature sensors, may differ depending on the chosen configuration, check that their connection is made through a dedicated T1 terminal, has been made in accordance with the documentation (pay particular attention to the correct connection of the 24V power supply and Modbus communication cables, (pay particular attention to the correct connection of the 24V power supply and Modbus communication cables, as their confusion may damage the entire communication bus of the control unit)
Electrical supply to the unit.	Check that the power supply is correctly connected to the main switch - the correct voltage must be applied to the block switchboard in accordance with the unit's wiring diagram in the relevant section of its technical data sheet or User's Manual (DTR).
Electric heater	<p>Check that the power supply to the electric heater (if any) is correctly connected - the appropriate voltage must be applied to the heater switchboard in accordance with the wiring diagram of the appliance in the relevant section of its technical data sheet or the User's Manual (DTR).</p> <p>During operation of the air handling unit (and also prior to its initial start-up), when the heater is not operating, dust may settle on the heating elements. When the heater is switched on again, the heavy soiling can cause a smell of burning dust or even a fire hazard.</p> <p>Check the condition of the electrical connections, the condition of the heating elements and the degree of dirt on a regular basis (annually), especially before the first start-up and before the start of the heating period. Remove any dirt with a Hoover with a soft nozzle or compressed air.</p> <p>The operation of the overheating protection and the no-airflow protection should also be checked regularly. The air velocity in the AHU during heater operation should not be less than 1.5 m/s.</p>
Closure of inspection panels.	Check that the inspection panels are closed - the rotating parts of the control panel can pose a risk to health and life when the protective covers are removed

9.1.2 POWER CONFIGURATION OF OPTIONAL ELECTRIC HEATERS



! If the unit is equipped with an electric heater, the heater's heating sections must be configured.

CONFIGURATION OF ELECTRIC HEATER POWER STAGES

Read the power distribution from the diagram or technical data sheet. For example, we have:

0-10V DC = 25%, ST2 = 25%, ST3 = 50%

This notation means that the step-adjustable part of a given heater is 25% of its power (0-10V DC). The second step - step-connected (ST2) is also 25%, while the third step-connected (ST3) is 50% of the total power of the heater.

These parameters should be reflected in the appropriate settings of the uPC3 controller. The settings are made on the HMI Advanced screens:

- A05 for the pre-heater,
- A09 for the main heater,
- A06 for the secondary heater,

In the event that in a given system does not have one or both of the stages with step connection (ST2 / ST3 are not indicated in the diagram), the value 0% should be selected in the controller settings.

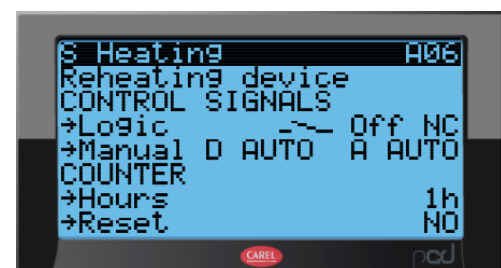
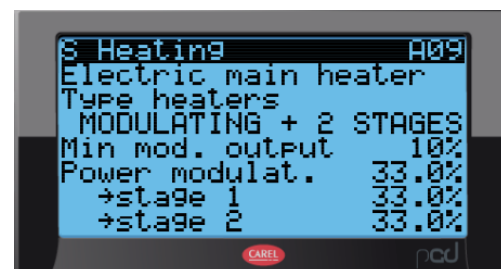
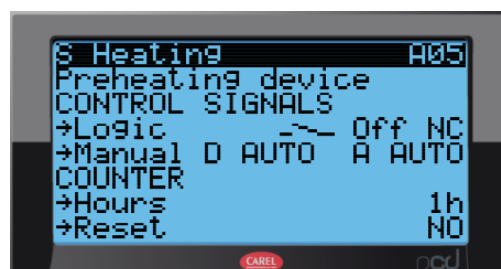

9.2 FIRST START-UP

9.2.1 FACTORY PARAMETERS



- ! The control unit, which is supplied as a Plug&Play standard, has its Control configured according to the parameters and criteria specified in the unit's selection sheet.
- ! No additional site configurations are required in order to run the control unit in Plug&Play in factory parameter mode (see "Preparing for initial start-up").
- ! VTS automatics has a wide range of parameters for adjusting the device's operation to the specifics of the facility's installation. In order to improve the comfort of use, it is recommended that such adjustment be carried out.
- ! For basic commissioning of the control panel, it is sufficient:
 - connect peripheral functions and peripheral Control elements depending on the depending on the retrofit options provided,
 - connect the fan sections (connectors located on the fan diaphragm for pressure measurement, control signal and power supply of the units),
 - connect the pneumatic differential pressure measurement lines of the air filters,
 - check the correctness of the connections made on the site,
 - check the correctness of the sensor readings and the functioning of the elements mounted on the site.

BASIC FACTORY CONFIGURATION

Configuration of the application code including:	Configuration and settings:	
<ul style="list-style-type: none"> • type and mode of heat recovery operation, • the type and parameters of the main heater, • the type and parameters of the pre-heater, • the type and parameters of the secondary heater, • the type and parameters of the reversible system, • mixing chamber parameters, • humidifier operating parameters (air humidity control), • occurrence of HMI Basic, HMI Basic2, 	<ul style="list-style-type: none"> • leading sensor, • type of temperature control, • type of humidity control, • type of supply fan control (CAV/ VAV), • type of extractor fan control (CAV/ VAV), • type of supply fan motor controller (EC), • type of extractor fan motor controller (EC), • PID controllers for fans and other functions in the application, 	<ul style="list-style-type: none"> • number of supply fans • number of exhaust fans • supply impeller size, • Exhaust impeller size, • discharge capacity, • exhaust performance, • discharge pressure, • the discharge pressure, • maximum speed for the supply fan motor, • maximum speed for the exhaust fan motor, • activation of the water heater touch sensor, • Activation of the humidity transmitter • Activation of the CO2 transducer (VOC sensor),

BASIC FACTORY CONFIGURATION - OPERATING PROFILES (MODE)					
PARAMETER			WORK PROFILES		
			Comfort**	Economic	StandBy
			Comfort**	Ekono	StandBy
Temperature	T	°C	22	22	22
Relative humidity - RH	RH*	%	50	50	50
Air quality - CO2 content	ppm	ppm	600	900	900
Supply capacity	V * _S	% m3/h	100	60	60
Exhaust capacity	V * _E	% m3/h	100	60	60

- Work profiles: Comfort, Economic require the time and date of their validity to be set in the calendar.
- Standby operating profile - requires parameter setting:
 - Standby time, i.e. the minimum time for which the AHU is awakened in StandBy mode,
 - Wake-up time, i.e. the time determining the interval between automatic wake-ups of the AHU in StandBy mode.
- * - humidity control requires the unit to be equipped with humidification and dehumidification functions, otherwise the values are read-only,
- ** - 100% means the capacity from the selection sheet.

9.2.2 COMMISSIONING

PLUG&PLAY CONTROL PANEL COMMISSIONING

Switch on the power supply to the control panel

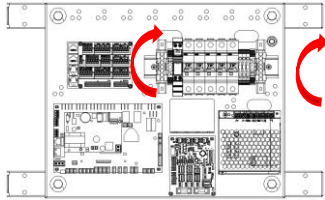

Enable HMI Advanced*

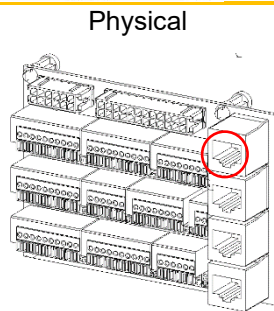

Virtual

<http://192.168.1.111>

Switch to OFF mode to any other mode (work profile) as preferred*

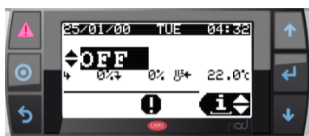

	Change in device status (operating mode)
OFF	Panel operation switched off (voltage reaching the panel)
ON	ECO One of the user configuration profiles
	OPTI One of the user configuration profiles
	COMF One of the user configuration profiles
StBy	Standby state of the unit. In the StBy state, the set room temperature is maintained. The fans are periodically activated to maintain the required air temperature. This mode is best at night when there is low or no thermal occupancy in the building.
AUTO	Schedule and calendar operation



- ! The start-up of the air handling unit is absolutely blocked by a fire alarm, the tripping of the thermal fan motor protection, the triple tripping of the electric heater protection and the triple tripping of the anti-FROST thermostat. Each of these events requires the cause of the alarm to be removed and then cleared.
- ! Correct operation of the power supply and proper functioning of the BIOS is indicated by the yellow and green LEDs on the control PCB. The system is ready for operation half a minute after power-up.
- ! - * Changing from OFF to another operating mode is also available from the HMI Basic 2

9.2.3 HMI ADVANCED

HMI ADVANCED - NAVIGATION

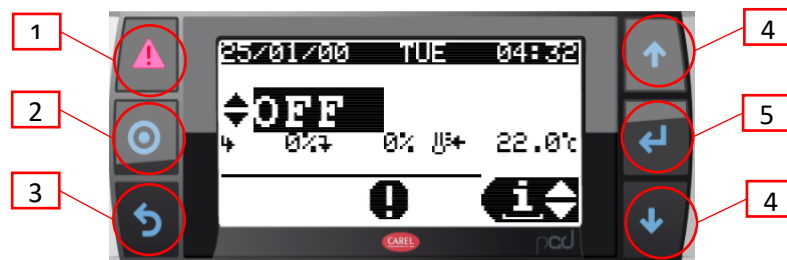

Simulation of equal pressures in the WEB HMI

1 "Alarm" button (calling up active and archived alarms, clearing alarms). When an alarm is active, the button is illuminated in red.

2 Button for changing the operating modes (OFF/Auto/Low/Econo/Comfort). Confirmation by pressing ENTER.

3 ESC button (return to previous field or screen)

4 Arrows to navigate up and down and to change parameter values

UP:

- Moving up through the menu screens (when the cursor remains in the top left corner)
- Increasing the parameter value

DOWN:

- Moving down through the menu screens (when the cursor remains in the top left corner)
- Decreasing the parameter value

5 ENTER button.

- selection of the parameter to be changed,
- transition to another parameter,
- validation of the selected value



! The parameters available in the LCD display window depend on the type of air handling unit and the application of the Control system. Therefore, in the case of AHUs without a heater, you will not see the options related to the heating section.

! The HMI Advanced cannot be used as a room temperature sensor.

HMI ADVANCED NAVIGATION cont.

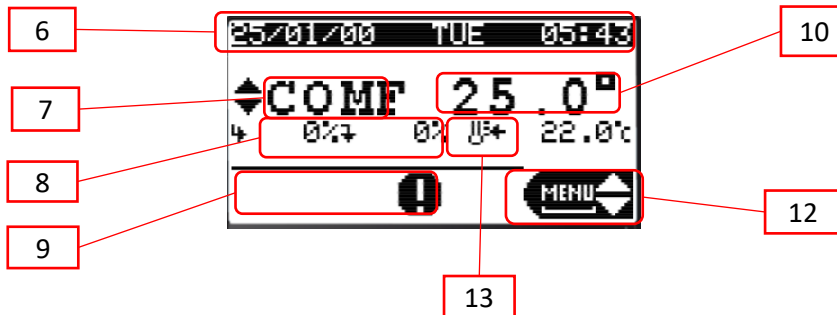

6	Current date and time.	12	HMI Advanced work module:
7	Current work profile		<ul style="list-style-type: none"> • Info" module (viewing the operating status of the control panel - available without logging in), • Set" module (change of settings of the operating parameters: capacity, temperatures, humidity, CO2 and setting of the timer - accessible without logging in), • Menu" module (allows configuration changes of the air handling unit and its components as well as programming of the EC motors, only available after logging in)
8	Current fan controls		
9	Air handling unit status (fans running/stopping, heating/cooling, activation of recovery)		
10	Current leading temperature value		
11	Lead temperature setpoint		
13	Operating status icon:		
	Opening/closing the throttles		Dehumidification
	Fan operation		Active recovery
	Heating		Detention on request
	Cooling		Emergency stop
	Moistening		Active calendar



- ! The parameters available in the LCD display window depend on the type of air handling unit and the application of the Control system. Therefore, in the case of AHUs without a heater, you will not see the options related to the heating section.
- ! The HMI Advanced cannot be used as a room temperature sensor.

9.2.4 HMI BASIC 2HY

HMI BASIC 2 HY

The HMI Basic 2 HY is a basic control panel designed to operate VTS air handling units equipped with the uPC3 controller. The functions realised are:

- starting and stopping the control panel,
- operating mode selection,
- the possibility to view and change the parameters of individual operating modes (temperature, humidity, CO2 level, fan speeds of supply and extract fans),
- reading of the leading, external and room temperatures (built-in room temperature sensor),
- setting up AHU operation according to a schedule,
- alarm handling (viewing, deleting)

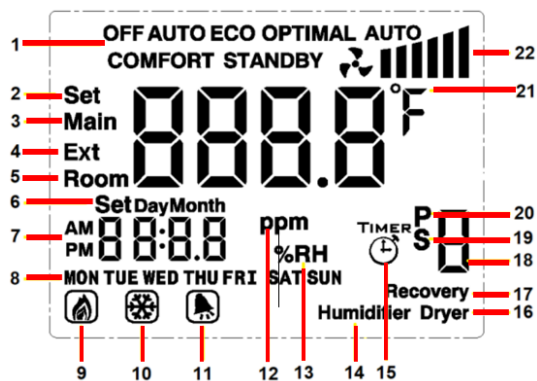

- | | | | |
|----|------------------------|----|---------------------|
| 1 | Current operating mode | 12 | Air quality |
| 2 | Setting temperatures | 13 | Moisture |
| 3 | Temperature leading | 14 | Moistening |
| 4 | Outdoor temperature | 15 | Daily schedule |
| 5 | Room temperature | 16 | Dehumidification |
| 6 | Date setting | 17 | Retrieved from |
| 7 | Clock | 18 | Option number |
| 8 | Day of the week | 19 | Special schedule |
| 9 | Heating | 20 | Interim schedule |
| 10 | Cooling | 21 | Temperature unit |
| 11 | Alarm | 22 | Fan operation level |

Current fan level control

Symbol	Fan control
	0 %
	0 < % ≤ 60
	60 < % ≤ 80
	80 < % ≤ 100

PUSH BUTTON	FUNCTION
	change of operating mode / change to setting menu / return to previous menu
	confirm selection / advance to next set-up parameters / return to general set-up menu
	switch between displayed temperatures / exit to main screen / switch off the screen



changing parameter values



- ! In the absence of communication with the controller, the HMI Basic 2 HY will only display the current room temperature.
- ! Activation of the panel in the air handling unit controller settings The panel is intended for air handling units equipped with the uPC3 controller with software version 1.0.019 or higher. In order to activate its operation, it is necessary to go from the HMI Advanced (physical, connected to the controller's pLAN port, or virtual, being part of the visualisation application) to the service menu and, on the I01 screen, change the last digit of the application code to 7.
- ! The default Modbus address of the HMI Basic 2 HY is 16. It can be changed on the I05 HMI Advanced screen (HMI Basic 2 line).
- ! If there is no communication between the AHU controller and the HMI Basic 2 HY, only the room temperature will be displayed on the HMI screen and the controller will report the corresponding alarm (A1096).
- ! If there is no communication between the AHU controller and the HMI Basic 2 HY, only the room temperature will be displayed on the HMI screen and the controller will report the corresponding alarm (A1096).

START-UP OF THE AIR HANDLING UNIT - CHANGE FROM OFF TO ON PROFILE (ECO / OPTI / COMFORT)

On the main screen, hold down the button and **SET** then select one of the modes (**Eco / Opti / Comfort**) with successive presses and confirm the selection with .

SWITCHING THE PANEL ON AND OFF

To switch off the panel screen, hold down the ON/OFF button .  Switching on is done by briefly pressing the same button. Switching off the HMI panel is not the same as with switching off the panel - to switch off the AHU, select the Off mode.

The display backlight is automatically switched off after a user-defined period of time. The backlighting is activated by pressing any key. After backlighting, it is possible to carry out further operations with the panel.





CHANGING THE PARAMETERS OF INDIVIDUAL OPERATING MODES

On the main screen, hold down the button and **SET** then select the mode of interest (Standby / Eco / Opti / Comfort) with successive presses and confirm the selection with .

We now have the option of setting the parameter values associated with a particular mode:



- the set temperature,
- humidity,
- CO2 levels,
- supply fan speeds (S),
- exhaust fan speeds (E).

Access to individual settings depends on the configuration of the control panel and its actual components.

Changes are made using   approvals by means of 
 Exit to home screen automatically after a moment of inactivity
 or by pressing 

SETTING THE OPERATING SCHEDULE FOR THE CONTROL PANEL

The HMI Basic 2 HY panel is equipped with the ability to set and modify the schedule of the air handling unit. Changes made from the HMIS BASIC 2HY panel also affect the schedule available in HMI Advanced and visualisation - it does not constitute a separate calendar, but allows full access to the existing one.

On the main screen, hold down the SET button and then select the Auto submenu with successive presses of   and confirm the selection with the button. 

One of the schedules is now selected with the key:

- **Timer** -  daily schedule, allowing up to 4 mode changes to be programmed each day at a selected time, separately for each day of the week. Select in sequence: the day of the week, activation (On / Off) of each action, the time at which it is to be performed and the mode to be set. By confirming the successive parameters, you proceed to the parameterisation of the next action (the numbers 1-4 displayed on the right-hand side indicate the action you are currently setting).
 - **P** - periodic schedule, allowing the selection of up to 3 periods per year during which the AHU is to operate in the selected mode (this type of schedule has a higher priority than the daily schedule). We select in turn: the activation (On / Off) of each period, its end date, start date and mode to be set. By confirming the successive parameters, we move on to the parameterisation of the next period (digits 1-3 displayed on the right-hand side indicate which period is currently set).
 - **S** - special schedule, allowing the selection of up to 6 special days per year on which the AHU is to operate in the selected mode (this type of schedule has a higher priority than the daily and periodic schedules). We select in turn: the activation (On / Off) of each special day, its date and the mode to be set. By confirming the subsequent parameters, you move on to the parameterisation of the next special day (the digits 1-6 displayed on the right-hand side indicate which one you are currently setting).
-

- T - not used

- ! Access to individual settings depends on the configuration of the control panel and its actual components. Output
- ! Exit to the home screen is automatic after a moment of inactivity or by pressing  .



ALARM HANDLING

The MI Basic 2 HY allows active alarms to be viewed and cleared. If an alarm is present, the bell symbol is shown on the main screen and the alarm number is displayed in place of the time.

The alarm is cancelled, once the cause of the alarm has been removed, by holding down  .

PROGRAMMING MODE

With the display switched off by holding down the button, hold down the button to enter the programming mode (change of advanced parameters).

Subsequent presses of **SET** toggle through the parameters and use   to set their value. The menu is automatically exited after a moment of inactivity or by pressing  .

Parameter	Scope	Default value	Description
IP	1-255	16	Modbus address
A1	2400/4800/9600	9600	Modbus - transmission speed
A2	0/1/2	0	Modbus - parity bit (0 = none, 1 = even, 2 = odd)
A3	12/24	24	Clock mode [h]
A4	00/01	00	Temperature units (00 = °C, 01 = °F)
A5	0-300	10	Screen backlight time [s]
A6	-9,9...9,9	0	Correction of the built-in temperature sensor [°C].

SPECIFICATION

Type of device	control panel; controller
Temperature measurement	0°C ... 70°C, 10k NTC
Service	physical membrane keyboard keys
Communication	Modbus RTU (2400 / 4800 / 9600 bps)
Power supply	110-230V AC
Power consumption	1.5 VA
Display	backlit, graphic LCD
Design	ABS + polyester

Dimensions (H x W x D)	86 x 86 x 17 mm
Permissible operating temperature	0°C ... 50°C
Destination	for indoor mounting (IP20)
Assembly	in a standard Ø60 installation box on a mounting bracket
Mass	150g



- ! In the absence of communication with the controller, the HMI Basic 2 HY will only display the current room temperature.
- ! Activation of the panel in the settings of the air handling unit controller The panel is intended for air handling units equipped with the uPC3 controller with software version 1.0.019 or higher. In order to activate its operation, it is necessary to go from the HMI Advanced (physical, connected to the controller's pLAN port, or virtual, being part of the visualisation application) to the service menu and, on the I01 screen, change the last digit of the application code to 7.
- ! The default Modbus address of the HMI Basic 2 HY is 16. It can be changed on the I05 HMI Advanced screen (HMI Basic 2 line).
- ! If there is no communication between the AHU controller and the HMI Basic 2 HY, only the room temperature will be displayed on the HMI screen and the controller will report the corresponding alarm (A1096).
- ! If there is no communication between the AHU controller and the HMI Basic 2 HY, only the room temperature will be displayed on the HMI screen and the controller will report the corresponding alarm (A1096).

9.2.5 BLUETOOTH MODULE AND mHMI APPLICATION

The Bluetooth module is designed for low-power Bluetooth V5.0 connectivity to mobile devices. The module transmits an RS485 serial transmission signal [Modbus RTU] from the master controller to the mobile device using a Bluetooth connection, thus eliminating the transmission cable. To use the Bluetooth module to control the VTS Control panel, install the dedicated mHMI application on the mobile device and connect to the dedicated Bluetooth mHMI module that has been connected to the VTS Control panel. For VENTUS COMPACT Plug&Play devices, it is installed at the factory, while for other devices it requires connection and configuration by the customer.

BLUETOOTH MODULE

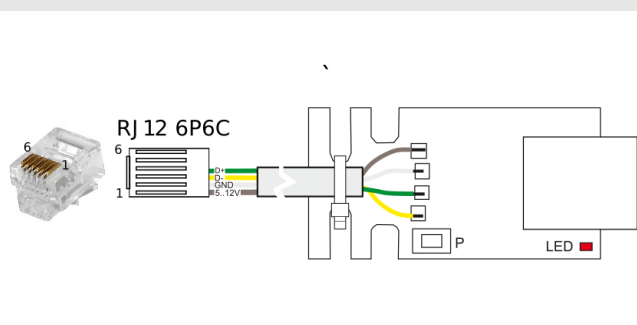
	Terminal	PIN	Designation
	0	=	earthing (shielded wire strand)
	1	1	+VRL 12V
	2	2	GND
	3	3	Rx-/Tx-
	4	4	Rx+/Tx+
	5	5	GNS
	6	6	+VRL 12V

Data transmission from RS485 [Modbus RTU] to Bluetooth V5.0.

Internally-built antenna - no external antenna required or connection possible.

Power supply

Degree of protection

Ambient temperature

ISM transmission

Dimensions

Assembly

Electromagnetic environments

Degree of environmental pollution

Development conditions

- Due to electrostatic discharge, it requires encapsulation so that the unit cannot be accessed during normal operation.
- Attach to the fixed installation elements of the unit. It should not be possible to bring the module close to live parts carrying dangerous voltages.

P button for configuration of serial communication data and pairing functions.

LEDs to indicate transmission and power supply.

5...12 VDC, 1 W (4A fuse)

IP 00

0° C...50 C°

Bluetooth V5.0, ISM 2.4 GHz, Transmission rate: 125 Kbps, 500 Kbps, 1 Mbps, 2 Mbps

60x22x5 mm

Stationary device for building in

Domestic or similar environments and industrial environments

2 acc. to IEC 62368-1

REQUIREMENTS:



- Control software uPC3 from 1.0.26
- Smartphone with systems from versions: Android 9, iOS 11
- Assignment of rights and activation:
 - location (linked to a Bluetooth connection)
 - bluetooth connections

BT MODULE SUPPORT

The unit allows other units to connect via the broadcast system. The default name of the module by which it broadcasts is the factory number of the air handling unit. For devices with an unconfigured control panel number, the module reports as "AHU Bluetooth".

By default, the server only allows previously paired devices to connect, this status is indicated by an off LED with a pulse on.

You can allow all devices to connect by holding down the pairing button for approximately 3 seconds. The LED will then be on with the pulse off. The server can be connected to a maximum of one client device at a time.

A server that is actively connected to another device has its LED constantly on.

LED STATES:

- **off** - offline mode / no power,
- **disabled with pulse** - server mode with the possibility of connecting new devices disabled,
- **enabled with pulse** - server mode with connection of new devices enabled
- **enabled** - server mode with active connection



- The app includes a tutorial for pairing and connecting the device.

The mHMI smartphone application has been developed for service technicians, as well as for end users of *VENTUS*, *VENTUS COMPACT* and *VENTUS COMPACT TOP air-handling units*. The app is available on: Play App Store and Apple App Store.

The application allows both the current change of settings and the detailed configuration of the operating parameters of the air handling unit and its components. The intuitive interface makes it easy to set up the basic functions of the control panel, making operation of the control panel a pleasure even for a user with no previous experience.

CONFIGURATION OF THE UPC3 CONTROLLER - mHMI and HMI ADVANCED

```
Unit cfg. 108
External add. Port
→Address 1
→Baudrate 38400
→PLan port
mHMI
```

```
Konfig. urzadz. 108
Port protokolow zew.
→Adres 1
→Predkość 19200
Port zew. ster. pLan
HMI Adv.
```

- "Address" - address of the controller used for external protocol communication
- "Speed" - speed (baudrate) of the external controller protocol
- "External port of the pLan controller" - type of protocol used by the controller's pLan port (RJ11 socket)

[for mHMI, the value of the pLan port parameter should be set to "mHMMI" accordingly].

- "Address" - address of the controller used for communication using the external protocol
- "Speed" - speed (baudrate) of the external controller protocol
- "External port of the pLan controller" - type of protocol used by the controller's pLan port (RJ11 socket)

[depending on the HMI selected, the value of the pLan port parameter should be set accordingly on the HMI Advanced

- ! If a Plug&Play VENTUS COMPACT device has been ordered together with an mHMI module, it has the parameters set for mHMI operation.
- ! The ability to modify the page requires access to a standard service password. Set the parameters as shown in the illustration.

ACTIVATION OF THE BLUETOOTH MODULE

Remove the control panel junction box housing.

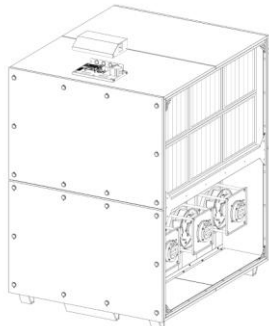

The BT module should be plugged into the T1 terminal.

If the BT module was ordered separately, plug it into the socket shown in the figure.

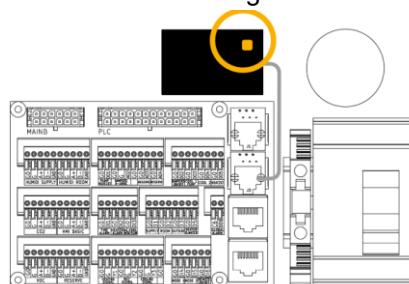
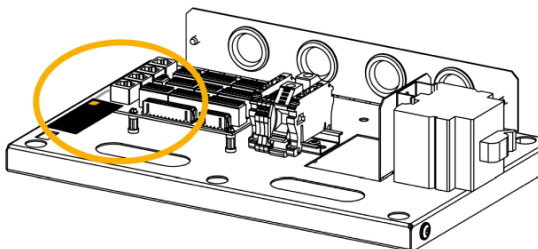

Find the button on the bluetooth (BT) module and press it until the LED starts flashing. This indicates that the BT is in pairing mode. Then go to the app and pair the control panel with the app. Pairing mode is active for 30s.

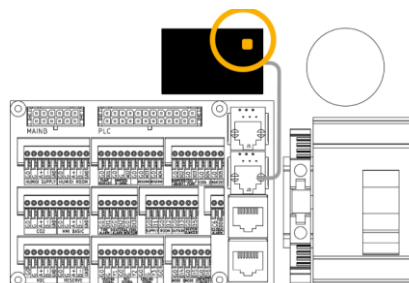
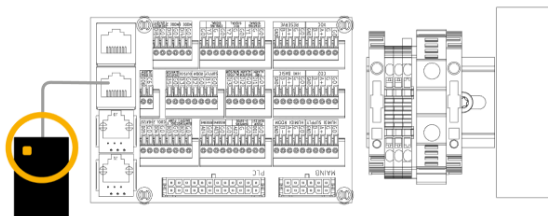

ADDING A DEVICE

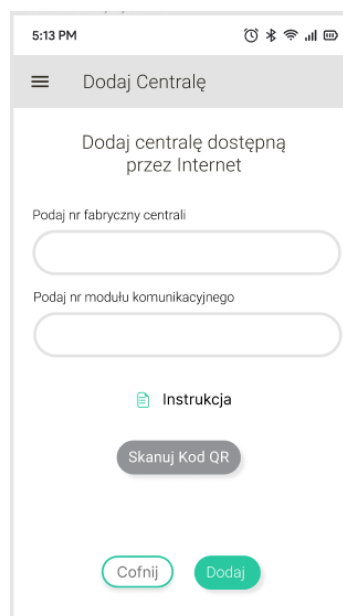
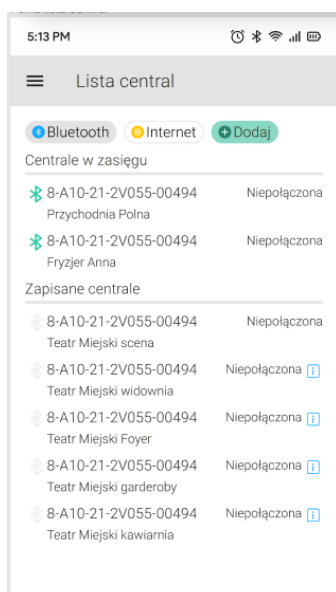

! If a Plug&Play VENTUS COMPACT device has been ordered together with an mHMI module, it already has a factory-programmed number in the application.

ACTIVATION OF THE DEVICE

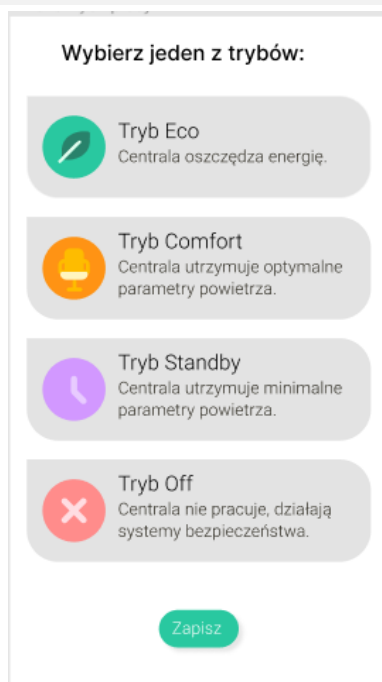
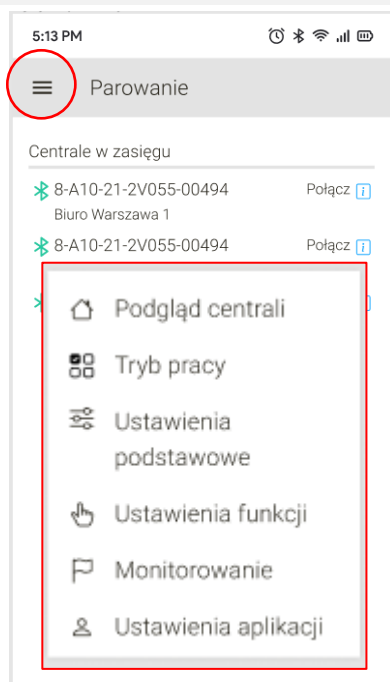

Select a paired device

Then, in the Menu, select one of the operating modes Operation Mode "On":

- Eco
- Comfort
- Standby
- Auto

Save your selection

OVERVIEW OF SELECTED ASPECTS OF THE mHMI APPLICATION



- The app includes a tutorial for pairing and connecting the device.

PANEL OVERVIEW

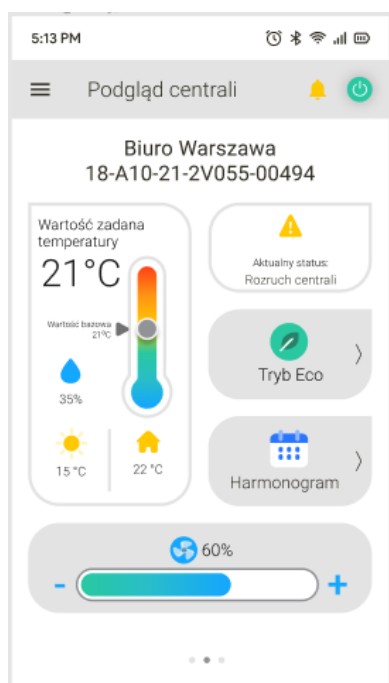

The PBX View contains the basic operating parameters of the PBX :

- outside air temperature,
- indoor air temperature,
- the set air temperature (of the lead sensor),
- degree of fan speed control,
- state of the panel,
- selected operation mode of the air handling unit: (eco, opti, comfort, auto, off)

Changing the target temperature

By clicking on the Thermometer icon, the user is able to continuously adjust the temperature within limits depending on the mode.

Changing the operating mode of the control panel

By clicking on the Modes icon, it is possible to change the current mode, as well as to change the settings for a particular mode.

Revision of the Work Schedule

After clicking on the Scheduler icon, it is possible to change the time settings with the assignment of modes to the harmonogram.

Changing fan speeds

In the bar at the bottom of the screen, it is possible to change the fan speed settings (within the settings specific to the operating mode). This can be done by clicking on + or - .

OPERATING MODE PARAMETERS

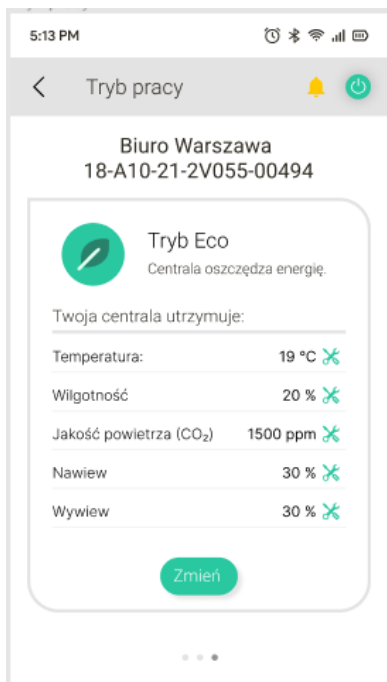

The Mode window presents the basic parameters relating to a particular mode and allows them to be edited quickly.

WORK SCHEDULE - CALENDAR

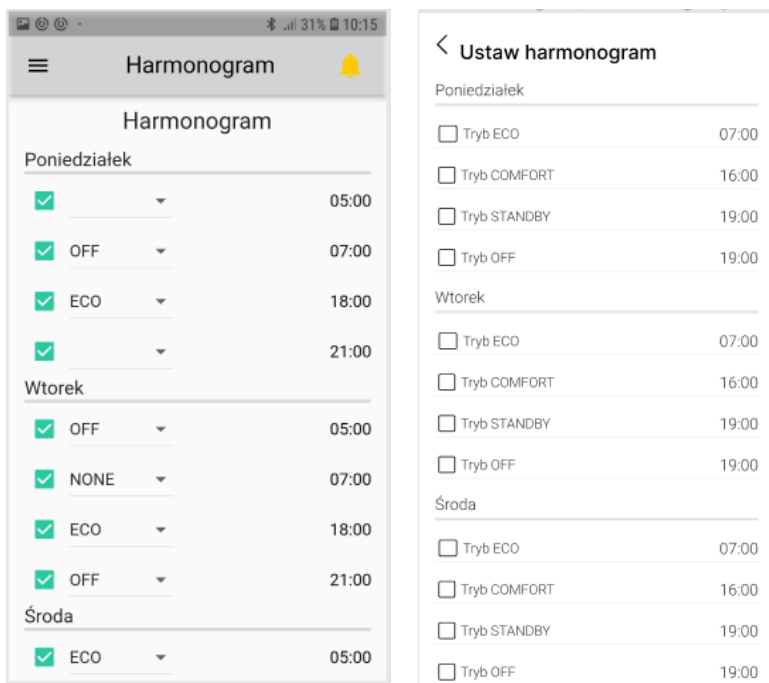

When the Schedule icon is selected, there is an option:

- to edit the days of switching on/off the control panel,
- to establish hourly intervals for the operation of the switchboard,
- assignment of the operating mode for a given time period .

ALARMS



The list of alarms is visible under the icon .

Alarms can be opened in one of two views:

- Current alerts,
- Historic alarms.

The list of historical alarms shows a preview of alarms that are not currently active.

If a situation occurs that affects to activate an alarm, it will be shown in the list of active alarms. The application screen will then turn red, to inform the user of the required response.

The 'Reset' button clears all alarms on the screen - current and historical.

If there is an active alarm, it will reappear in the current list.

FUNCTION SETTINGS - ADVANCED FUNCTIONS

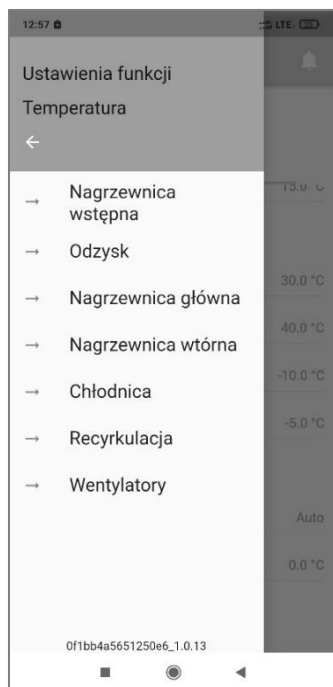

FUNCTION SETTINGS - this menu section gives you the possibility to view and edit the operating parameters of the associated control panel. In addition, you can access the control of individual inputs and outputs located on the control panel controller and also on the expansion board.

TEMPERATURE - The temperature settings section contains settings for all possible components that affect the resulting supply temperature.

FUNCTION SETTINGS - ADVANCED FEATURES (cont'd)

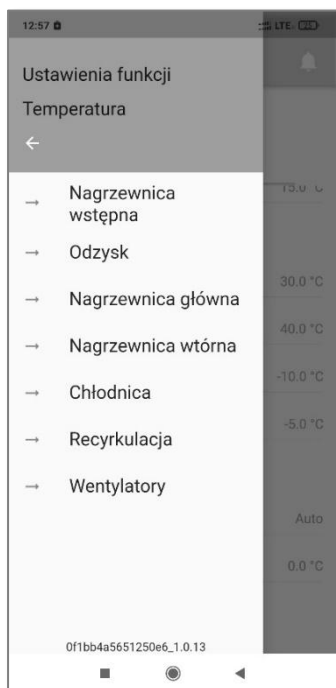

- **PRIMARY HEATER** - settings of the pre-heater operating parameters, e.g. PID, start and end points (if available in the air handling unit).
- **RECOVERY** - parameter setting for the heat exchanger.
- **MAIN HEATER** - settings of main heater operation parameters (if available in the air handling unit).
- **REPEAT HEATER** - settings of secondary heater operation parameters (if available in the air handling unit).
- **COOLER** - settings of the cooler operation parameters (if available in the air handling unit).
- **RECYCLATION** - settings for the air recirculation function (if available in the air handling unit).
- **FANS** - settings including fan speed, PID algorithm, fan start and stop delay time. CAV/VAV control.
- **MOISTURE** - possibility of setting, among other things, the PID parameters of the humidification process, extreme points for the start and end of humidification.

FUNCTION SETTINGS - ADVANCED FEATURES (cont'd)

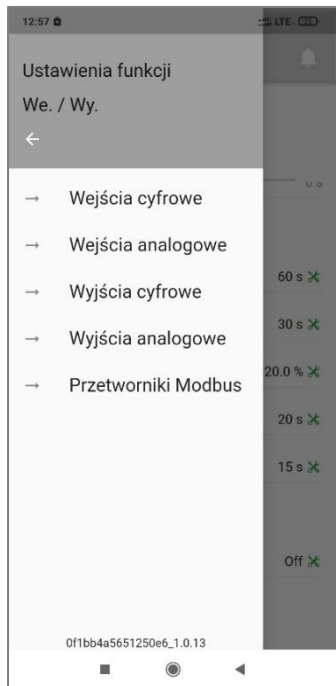

I/O. - Configurable digital and analogue inputs and outputs as well as ModBus signals. and analogue inputs and outputs as well as ModBus signals. The inputs and outputs have been labelled with the functions they are assigned, e.g. D11 - Fire alarm - is the digital input responsible for the fire alarm.

- Digital inputs,
- Analogue inputs,
- Digital outputs,
- Analogue outputs,
- Modbus transducers - ability to view and edit parameters relating to transducers: pressure, humidity, CO2,

FUNCTION SETTINGS - ADVANCED FEATURES (cont'd)

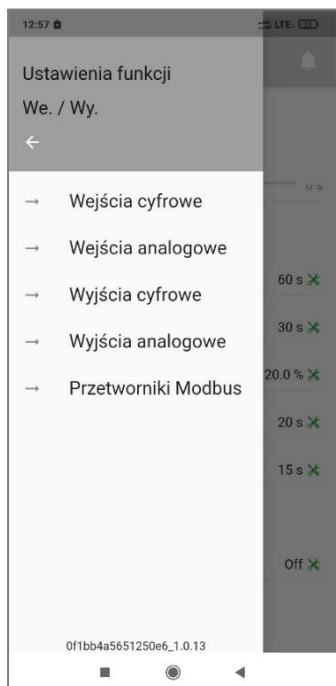

I/O EXPANSION MODULE

- Main board - allows the reading of the parameters of the signals connected to the main board of the control panel, the activation/deactivation of the expansion board, as well as the setting of values such as: maximum pressure values, pressure offsets,
- EC PCB - it is possible to change the settings of the inputs and outputs present on the PCB
- HMI Basic - allows the settings for the HMI Basic panel to be edited

UNIT

- Adjustment
- BMS - variables used for communication with BMS systems
- Access levels - there are 3 levels of access: user, service technician and manufacturer.

MONITORING

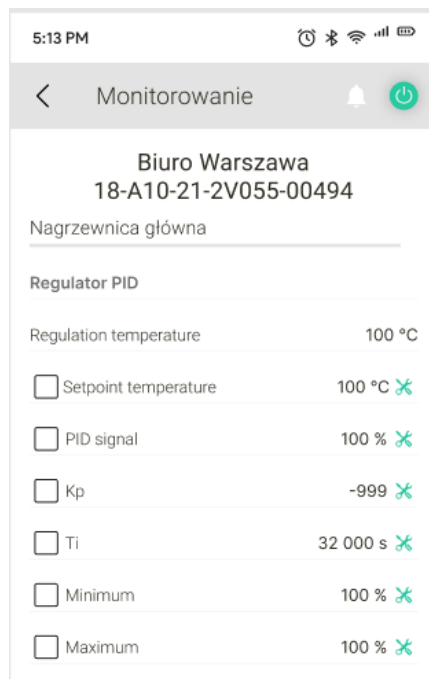
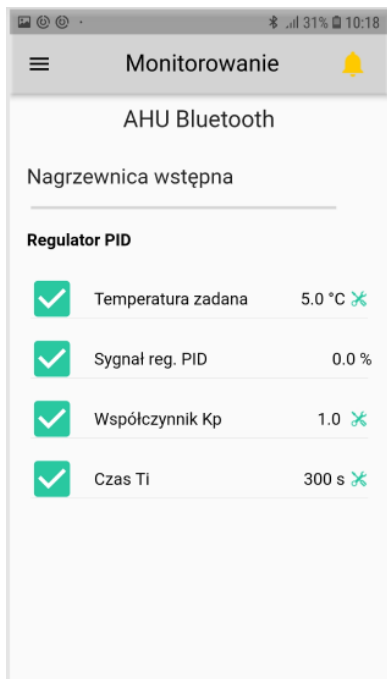

MONITORING

The user can define a quick-view list of selected parameters.

To use this functionality, the user must save the selected parameters in the **MONITORING** section

APPLICATION SETTINGS

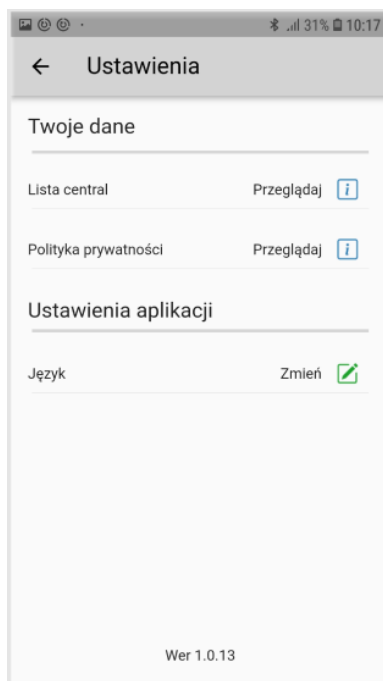
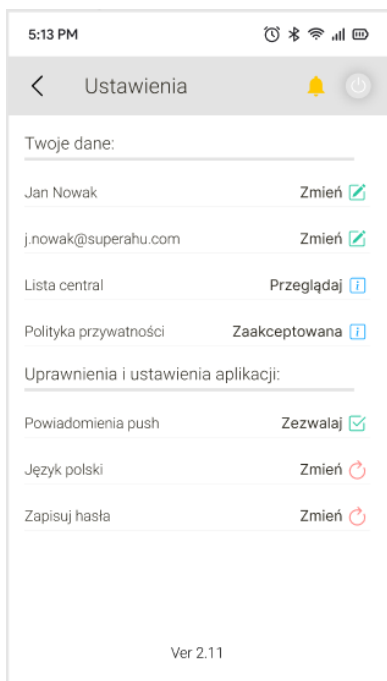

APPLICATION SETTINGS

General settings section, which is not related to operating parameters. Here it is possible to min:

- give the connected PBX its own name,
- display a list of the exchanges saved and currently detected by the Bluetooth module,
- changing the language of the application,
- restore the panel to factory settings,
- changing the display units for parameters.

9.2.6 OPERATING MODES OF THE CONTROL PANEL

OPERATING MODES OF THE CONTROL PANEL	
OFF	Air handling unit switched off - fans stopped, air dampers and control valves closed all sensors and measuring devices remain active - to protect the unit from damage, e.g. fire alarm, anti-FROST protection.
AUTO	Panel operation dependent on calendar programming
LOW	Lower economy mode - Fan speed as well as the dead zone in temperature control are adjustable. The temperature control algorithm can use a wide dead zone, while the fans can be set to low speed to reduce energy consumption.
EKON	higher economy mode - The fan speed as well as the insensitive zone in the temperature control are adjustable. The temperature control algorithm can use a narrower insensitive zone, while the fans can be set to a higher speed to optimise energy consumption.
COMFORT	Factory setting of selection parameters. The settings can be modified by the user.
HMI BASIC	Basic mode - external control signals (binary inputs) of critical temperatures, e.g. too low a temperature, trigger the control unit and immediately heat the room.

9.2.7 VERIFICATION OF OPERATION DURING INITIAL START-UP

During the initial start-up, it is recommended that the steps listed below be carried out.

CHECKING THE OPERATION OF THE FANS

Check that the fans do not make excessive noise (make sure that the impeller does not rub against the hopper and that there are no foreign bodies within the fans' operating range, which may be caused by improper transport or storage conditions),

CHECKING THE OPERATION OF THE AIR DAMPERS ACTUATORS

- Check that they close and open completely without resistance (this can be done by observing their operation during start-up/shut-down of the air handling unit or by pressing the button on the actuator to release its locking mechanism and moving the blades manually),
- Check that they open and close in the correct direction (dampers should open when the control panel start-up sequence is activated and close when the control panel is deactivated - check that they are operating in the correct sequence at the time - the actuators are equipped with a button to change direction in the event of wrong direction),
- For actuators with 0-10V signal, it is necessary to check if they operate correctly in their full range (0-10V actuators are always used for passive bypass of recovery and mixing chamber dampers - in case of air handling units with a mixing chamber, additionally supply and exhaust dampers can also be steplessly regulated by 0-10V voltage). - this can be done by observing its operation during the air handling unit's operation or manually feeding the control signal to the relevant screens of the mixing or recovery chamber controller (set D to ON and A to the selected percentage value).

```
S Mixing Damper E01
Eco damper
CONTROL SIGNALS
→Manual D AUTO A AUTO
```

```
S Recovery D01
Recovery device
CONTROL SIGNALS
→Logic ~ Off NC
→Manual D AUTO A AUTO
COUNTER
→Hours 0h
→Reset NO
```

CHECK OF SENSOR READINGS

- check if the readings from temperature, pressure, CO2 and humidity sensors are correct (at the beginning, when the air handling unit is powered but not operating, temperatures sent to the controller from temperature sensors should oscillate within the ambient temperature range of the air handling unit's air, while the remaining transmitters and sensors should show typical values for the given environment - e.g. most often for the CO2 sensor it will be values below 600ppm for fresh air and initially zero values of flow and pressure before starting the fans on transmitters' pressure, their values should change accordingly within the expected range once the unit is set up for operation).

```
I/O status Sc01
Temperatures
B1 Supply 0.0°C
B2 Return 0.0°C
B3 External 0.0°C
B4 Recovery 0.0°C
B5 Water heat 0.0°C
```

```
I/O status Sc02
Temperatures
B6 Rec. Supply 0.0°C
Water preheat 0.0°C
After preheat 0.0°C
TH Room 0.0°C
```

```
I/O status Sc03
Humidities
Room 0.0%rH
Supply 0.0%rH
Return 0.0%rH
```

```
I/O status Sc04
Pressures
Supply 0.0Pa
Return 0.0Pa
```

```
I/O status Sc05
Return CO2 value 0.0PPM
```

```
I/O status Sc38
Pressure filters
Supply 0.0Pa
Supply 2 0.0Pa
Supply 3 0.0Pa
Return 0.0Pa
Return 2 0.0Pa
```

CHECKING THE OPERATION OF THE WATER HEATER VALVE ACTUATORS

Check that the heater valve actuator responds to the control signal - manually actuate the valve from the controller's service menu and observe whether it causes the valve to open/close accordingly.

To do this, set parameter D to ON and parameter A to the desired percentage in the corresponding screen in the service menu, depending on the type of heater you have and the function it performs [screens A01, A03, A05, A06. (See "DESCRIPTION OF THE UPC3 CONTROLLER MASKS")]

CHECKING THE OPERATION OF THE WATER HEATER CIRCULATION PUMP

Check that the heater circulation pump responds to the control signal - manually set the valve from the controller's service menu and observe whether it causes the pump to switch on/off accordingly.

! Remember to restore the original settings of the D and A (Auto) parameters after the test.

9.2.8 MEASUREMENT OF AIR VOLUME

The measurement of air volume is an essential measurement for:

- commissioning and technical acceptance of the air handling unit,
- if the system does not perform as required and expected,
- periodically check the operation and efficiency of the air handling unit,
- replacement of fan assembly components.

Before taking measurements and making adjustments, make sure, that the dampers on all grilles or gates are positioned as designed.

Determination of the amount of airflow is most often based on the measurement of the average airflow velocity in a test cross-section of a duct. One of the most common methods for determining the average flow velocity is the cross-sectional sounding method using a Prandtl tube and measuring the flow velocity-related mean dynamic pressure.

Key factors that affect measurement accuracy are:

- the position of the cross-section to be measured in relation to the elements causing distortion of the flow velocity (elbows, orifices, tees, butterfly valves, etc.),
- the number and location of test points in the cross-section to be measured,
- stable and constant airflow,

The measurement must be carried out in a section of duct with parallel walls and straight sections at least 6 times the hydraulic diameter of the duct or the corresponding diameters upstream of the test point and no less than 3 diameters downstream of this point. In a real ventilation system, finding such a long straight section may be a problem. In this case, the position of the cross-section should be determined at the point where the least flow disturbance is expected, increasing the number of measurement points. The location of the measuring cross-section should be determined at the system design stage.

An estimate of the measurement result is considered sufficient if it does not differ by more than $\pm 10\%$ from the design value. In the case of greater discrepancies, an approximation of the measurement result to the design value may be obtained by:

- adjustment of the ventilation duct network,
- changing the setting of the main throttle,
- changing the fan speed

9.2.9 THE MOST COMMON ADAPTATIONS TO THE NEEDS OF THE FACILITY

FUNCTION	SCREEN	SCOPE OF THE CHANGES	WHEN TO CHANGE
MAIN HEATER	A07	PID	unstable temperature control
DXH MAINTAIN	A11	compressor switch-on thresholds	unstable temperature control
SECONDARY HEATER	A12	PID	unstable temperature control
PRE-HEATER	A16	PID, post-heat temp. settings, min/max power	unstable temperature control
MAIN RADIATOR	B03	PID, min/max power	unstable temperature control
DX MAINTAIN	B05	compressor switch-on thresholds	unstable temperature control
VENTILATORS	C16	PID	unstable temp. control
VENTILATORS	C16	setting of capacity dependence on temp. reg.	matching of object properties
RECOVERY DEVICE	D02	PID, min/max power	unstable temperature control with heat recovery
RECOVERY DEVICE	D03	PID	unstable temperature control with cooling recovery
MIXING CHAMBER	E02	PID in the heating direction	Unstable temperature control with inefficient heat source
MIXING CHAMBER	E03	PID in cooling direction	Unstable temperature control with inefficient heat source
GENERAL	H01	min/max temp, min/max temp setting	matching of object properties
VENTILATORS	H02	PID efficiency depending on temp. reg.	unstable regulation of performance on temperature
GENERAL	H03	heating/cooling switchover thresholds	unstable temperature control
GENERAL	H04	StdBy" mode parameters	matching of object properties
GENERAL	I02	selection of the leading temperature	matching of object properties
N VENTILATORS	C07	PID`	unstable capacity regulation
FANS W	C08	PID	unstable capacity regulation
VENTILATORS	C12	PID	unstable co2 control by changing output
VENTILATORS	C12	setting the performance relationship to the CO2 reg.	matching of object properties
MIXING CHAMBER	E04	PID	unstable co2 control by changing recirculation
MIXING CHAMBER	E06	parameters of the "rapid heating" function	matching of object properties
HUMIDIFIER	F02	PID	unstable humidity control
BED HUMIDIFIER	F03	humidifier on/off threshold	unstable or inaccurate humidity control
GENERAL	I02	selection of the leading moisture content	matching of object properties
HMI BASIC	I05	Sensor activation in the HMI Basic	adaptation to the needs of the site
DXH MAINTAIN	A10	compressor run-time setting	
DXH INTRODUCTION	A14	compressor run-time setting	
DXH INTRODUCTION	A18	compressor run-time setting	
AHU	A21	next min. air temp. and switch-off delay.	object sensitive to low air temperature

FUNCTION	SCREEN	SCOPE OF THE CHANGES	NOTES
PRE-HEATER	A29	supply air heating support	object sensitive to low air temperature
AHU	A21	next min. air temp. and switch-off delay.	object sensitive to low air temperature
DX MAINTAIN	B04	compressor runtime setting	
VENTILATORS	C11	fire settings	matching of object properties
RECOVERY DEVICE	D06	set. share of defrosting methods	Lack of heat source capacity or object sensitive to reduction in discharge capacity
HUMIDIFIER	G08	humidifier alarm - logic	matching the properties of the humidifier
DIGITAL INPUTS	G07	fire entrance.	matching the characteristics of the fire installation.
DIGITAL INPUTS	G07	heating, cooling alarm	adjustment to the characteristics of the foreign heating/cooling source
DIGITAL OUTPUT	G09	Collective alarm logic	adaptation to the needs of the site
REC. MAIN ELECTR.	A09	setting the power distribution of the heaters	configuration setting
REC. ELECTR.	A13	setting the power distribution of the heaters	configuration setting
REC. PRE ELECTR.	A17	setting the power distribution of the heaters	configuration setting
DXH	A22	aggregate control signal scaling	matching the characteristics of the cooling source
DXH	A23	set min. temp.	matching the characteristics of the cooling source
VENTILATORS	C05	set. vent. type. and. nominal. output.	
VENTILATORS	C06	Pressure settings for VAV controllers	matching of VAV controllers
RECOVERY DEVICE	D03	activation of cooling recovery	
MIXING CHAMBER	E05	min/max working range setting	min - minimum air exchange required in the facility, max - installation of intake and discharge less than N and W
MIXING CHAMBER	E07	set. working method for individual profiles	adaptation to the needs of the site
STEAM HUMIDIFIER	F01	logic of operation, plausibility check	humidifier outside the VTS range
DIGITAL INPUTS	G08	remote AHU profile setup (setting profile type and NC/NO logic)	adaptation to the requirements of the facility
DIGITAL INPUTS	G08	Input logic External summer/winter mode override	adaptation to the requirements of the facility
DIGITAL OUTPUT	G09	glycol recovery pump start-up logic.	matching the control characteristics of the glycol pump
DX, DXH	G10	logic of outputs ON stage I and II heating/cooling.	matching the characteristics of the cooling source
HUMIDIFIER	G11	logic of work permit exit	matching the properties of the humidifier

FUNCTION	SCREEN	SCOPE OF THE CHANGES	COMMENTS
PRE-HEATER	G11	logic of work permit exit	matching the properties of the heater
SECONDARY HEATER	G11	logic of work permit exit	matching the properties of the humidifier
TRANS. VENT. REDUN.	G11	logic of work permit exit	adjustment to control characteristics throughput.
PROCESSED. PRESS. FILTERS	G18	activation of transducers	additional air filters
ADDITIONAL FILTERS.	G20	type of filter	additional air filters
ADDITIONAL FILTERS.	G21	max. pressure drop	additional air filters
CONTROLLER	I02	progr./operation mode switchover	AHU configuration change, first launch????
VENTILATORS	I03	type of control CAV/VAV/none	matching the properties of the ventilation system
HMI BASIC	I05	alarm reset authorisation from HMI Basic	adaptation to user requirements
CONTROLLER	I11	export/import of controller settings	parameterisation of several identical AHUs, archiving of settings
HMI BASIC	J03	activation, address	
FILTERS	J09	type, max. pressure drop	Changing the filter type, adapting to the needs of the object
VENTILATORS	J11, J12	set. control external analogue signal	adaptation to the needs of the facility
HMI, PLC	I06	selection of schedule source (Basic/uPC/none)	customisation
LEVEL OF ACCESS	K01	logout	end of setting change
AHU	Sa01	preview of current AHUs	
AHU	Sa03 to S07	changes to the settings of the current parameters	current needs of the facility
HMI	Sa08	setting the date and actual time	
HMI	Sa09 to Sa11	setting the work schedule	customisation
TEMP.	G05	B1 and B3 calibration	cable length > 5 m

DESCRIPTION OF UPC3 CONTROLLER MASKS

A description of the uPC3 controller masks is available in the dedicated manual "AHU uPC3 Controller Masks Description upc3"

10 MAINTENANCE

10.1 MAINTENANCE



- ! Personnel responsible for operating the control panel should read the documentation before starting any operations and maintenance activities. In the absence of such personnel with the necessary skills and competence, periodic inspections should be carried out by authorised VTS service providers.
- ! The basic technical data of the air handling unit, such as the type, parameters and dimensions of the most essential components (filters, heat exchangers, fans, electric motors), can be found in the technical data sheet that is supplied with each unit.
- ! All maintenance work on air handling units should be carried out with the unit switched off. To ensure safe operation of the unit, the service switch, which cuts off the power supply to the motor during maintenance work, must be installed outside the fan section. Disconnection of the power supply circuit by the service switch must take place in a de-energised state. The service switch should be located near the inspection panels of the fan section.
- ! Thorough and regular maintenance as well as technical inspections of air-handling units and their components are essential in order to identify faults at an early stage - before more serious failures and damage occurs.
- ! This documentation only covers general guidelines for inspection intervals to ensure fault-free operation of the units under the various possible external operating conditions. The technical inspection intervals must be adapted to the local conditions (level of contamination, number of start-up cycles, loads, etc.).

AIR FILTERS

- Under standard operating conditions for air handling units, filters should be changed approximately twice a year. The need to change the filter (in addition to visually visible contamination) is also indicated by a drop in pressure:
 - Coarse 80% (EU4) - 150Pa,
 - ePM10 40% (EU5) - 250 Pa,
 - ePM2.5 65% (EU7) - 250 Pa,
 - ePM1 80% (EU9) - 350 Pa,
- If the final differential pressure exceeds the design value, the filter must be replaced. The filters are disposable components.
- When changing the filter, the filtration section should also be cleaned - either with a Hoover or by dry cleaning.
- When ordering a new filter set from an authorised VTS office, specify the type of filter, the filtration class, the size of the air handling unit and, if necessary, the size of the filter, as specified on the technical data sheet or in the "AIR FILTERS" section.
- Incorrect or contaminated filters can cause an increase in the power consumption of the fan motors, leading to damage to the drive motors.

HOT WATER HEATER / CHILLED WATER COOLER

- Active water heaters should be equipped with anti-FROST systems. Optionally, a non-freezing heating medium (e.g. glycol solution) can be used in winter. If the heating medium is cut off or the air handling unit is at a standstill, and if the air temperature is likely to fall below + 5°C, the heater should be drained. To do so:
 - close the heating medium inlet and outlet valves (isolate the heater from the heating system),
 - remove the inspection panel,
 - unscrew the drain and remove the vent plug from the collectors,
 - connect the output hose to a drain, allowing water to run off the drained exchanger outside the unit,
 - blow compressed air through the vent plug into the heater,
 - repeat this procedure several times in short intervals until there are no visible drops of water coming out of the drain hose,
 - screw the drain plug and vent plug back in.
- Check the level of dirt on the heater plates at least once every four months. Dust settling on the surface of the heater causes a deterioration of its heating power and leads to a pressure drop on the air side. Even if the air handling unit is equipped with filters, over time dust, supplied with the delivered air, settles on the heater plates. If the plates become dirty, their cleaning should be carried out in one of the following ways:
 - using a Hoover with a soft suction nozzle on the air inlet side,
 - by blowing with a jet of compressed air against the direction of normal air flow, directing the jet parallel to the tiles,
 - washing with warm water and non-corrosive cleaning agents for aluminium or copper components.
- Protect adjacent sections of the air handling unit from contamination before cleaning.
- In order to achieve the maximum heating capacity of the heater, it must be well vented. For this purpose, vent plugs have been designed, located on the heater manifolds.
- When the unit is stationary, the flow of the heating medium should be limited to a minimum so that the temperature inside the unit does not exceed +60°C. Exceeding this value could cause damage to some components or subassemblies (motor, bearings, plastic parts, etc.) installed in adjacent sections.

ELECTRIC HEATER

- The electric heater battery consists of bare heating coils. During operation of the air handling unit, when the heater is switched off, dust may settle on the heating coils. When the heater is restarted, heavy contamination of the surface of the heater can generate unpleasant burning dust odours, even leading to an initial fire hazard.
- Check all electrical connections, the condition of the heating elements and the level of dirt on a regular basis (every 4 months) and especially before the start of the heating season. Any dirt should be removed with a Hoover with a soft tip or compressed air.
- The operation of the overheating protection system in the absence of air flow should also be checked. The air flow velocity should not be less than 1.5 m/s.



! WET CLEANING OF ELECTRIC HEATERS IS NOT ALLOWED

DX HEATERS AND DX COOLERS (FREON)

- Maintenance of the freon cooler covers the same range of operations as maintenance of the heater and water cooler. Before washing the freon cooler with warm water, the cooling system should be emptied by draining the freon into a container. Otherwise, there will be a risk of an uncontrolled increase in freon pressure, causing damage to the cooling system.

HEAT RECUPERATOR (COUNTER-FLOW, HEXAGONAL, CROSS-FLOW)

Maintenance of the exchanger is limited to checking its technical condition and the degree of fouling of the aluminium plates, once every 4 months. The accumulation of dirt in heat exchangers is often limited to the first 50 mm in the exchanger. Before cleaning, the adjacent sections must be protected.

The necessary cleaning should be carried out by one of the methods by:

- vacuuming with a soft squeegee,
- Blowing the ducts with an air jet in the opposite direction to the normal air flow,
- washing along the entire length of the air ducts with water and non-corrosive aluminium cleaning agents,
- in the case of more dirty exchangers, they can be cleaned by rinsing with a high-pressure water jet.

Special care must be taken during cleaning when using mechanical dirt removers and care must be taken that the exchanger plates are not deformed or damaged. When operating the exchanger in freezing temperatures, the exchanger must be thoroughly dried before restarting the air handling unit.

Check:

- throttle operation,
- condition of the condenser,
- status of tray discharge,
- ease of draining condensate,
- Fill the siphon with water before starting the unit,
- anti-FROST system (if present),

SOUND ATTENUATORS (DAMPING BAFFLES)

The silencer section is fitted with baffles made of non-combustible mineral wool to absorb acoustic energy. Maintenance procedures include checking the contamination level of these baffles.

FAN UNIT

- Before carrying out any work (repair, maintenance, service) on the air handling unit, especially when opening inspection panels in the fan section and when removing covers over the drive system, ensure that:
 - the appliance has been properly disconnected from the power supply. This applies to both primary and secondary circuits,
 - the rotor does not turn,
 - The fan surfaces are cool and temperature-safe to the touch,
 - the fan is protected against unintentional start-up.
- The fans are designed for dust-free air flow or air with a light dust content. They are not designed to operate with aggressive gases, vapours or in a highly dusty environment. Operating the fans in an unsuitable environment can lead to bearing damage, corrosion, impeller imbalance or vibration.
- The fan and motor of the unit are designed to meet specific requirements and for special operating characteristics. The fan speed is set so that the air flow and the total impeller stress concentration are appropriate for the ventilation system. A lower forced air flow rate causes operational disturbances and leads to an imbalance of the entire ventilation system.
- This can be caused by:

- dust deposition on the fan impeller blades,
- Wrong direction of fan rotation. If the centrifugal fan rotates in the wrong direction, the air flow causes significantly harmful effects.
- When performing maintenance on the fan, check that:
 - the rotor turns freely, - the rotor is properly balanced,
 - the rotor is securely mounted on the journal,
 - has not changed position in relation to the inlet cone,
 - all fixing screws of the fan components are tightened.
 - rotor imbalance can be caused by:
 - dust deposition on the rotor blades,
 - detachment of additional balancing weights,
 - damage to the rotor blades.
- The contamination level of the inside of the housing, rotor and motor should be checked every four months.
- Cleaning should be carried out by vacuuming or wiping all surfaces with a wet cloth. For more serious soiling, nylon brushes can be used:
 - the inside of the housing using a Hoover,
 - rotor with a Hoover or by damp wiping with a cloth dampened in a soft cleaning agent.





! For EC motors use bearing type: 6202 ZZ C3E

10.2 CONSUMABLES



SKANUJ I KUP
ZESKANUJ KOD QR NA SWOJEJ CENTRALI LUB
ZNAJDZ ZESTAW FILTRÓW PO NUMERZE URZĄDZENIA

KUP ZESTAW FILTRÓW
ONLINE
www.eshop.vtsgroup.com

! Spare parts are available from the manufacturer's online shop and from the network of authorised service centres www.eshop.vtsgroup.com.

! Simply enter the factory number

10.2.1 FILTRY POWIETRZA

AIR FILTER	CLASS	WxHxL	VVS 023c	VVS 033c	VVS 043c
MiniPleat	ePM10 40% (EU5)	742x410x48	1		
		490x490x48		1	
		490x287x48		1	
		592x490x48			1
		592x287x48			1
	ePM2,5 65% (EU7)	742x410x48	1		
		490x490x48		1	
		490x287x48		1	
		592x490x48			1
		592x287x48			1
Bag (300 mm)	ePM10 40% (EU5)	742x408x300	1		
		490x490x300		1	
		490x287x300		1	
		592x287x300			1
		592x490x300			1
	ePM2,5 65% (EU7)	742x408x300	1		
		490x490x300		1	
		490x287x300		1	
		592x287x300			1
		592x490x300			1

BAG FILTERS 600mm

A x B x L	428 x 287 x 600	428 x 428 x 600	490 x 490 x 600	592 x 592 x 600	592 x 287 x 600	ePM 2.5 65% (EU7) ePM 1 80% (EU9)
VVS021c	2					
VVS030c		2				
VVS040c			2			
VVS055c				2		
VVS075c	3	3				
VVS100c	3		3			
VVS120c				3	3	
VVS150c			8			

BAG FILTERS 300mm

A x B x L	428 x 287 x 600	428 x 428 x 600	490 x 490 x 600	592 x 592 x 600	592 x 287 x 600	ePM10 40% (EU5) ePM 2.5 65% (EU7)
VVS021c	2					
VVS030c		2				
VVS040c			2			
VVS055c				2		
VVS075c	3	3				
VVS100c	3		3			
VVS120c				3	3	
VVS150c			8			

10.3 ELECTRIC HEATER DIAGRAM

10.3.1 LOW POWER – 6KW – VVS023c, VVS033c

C

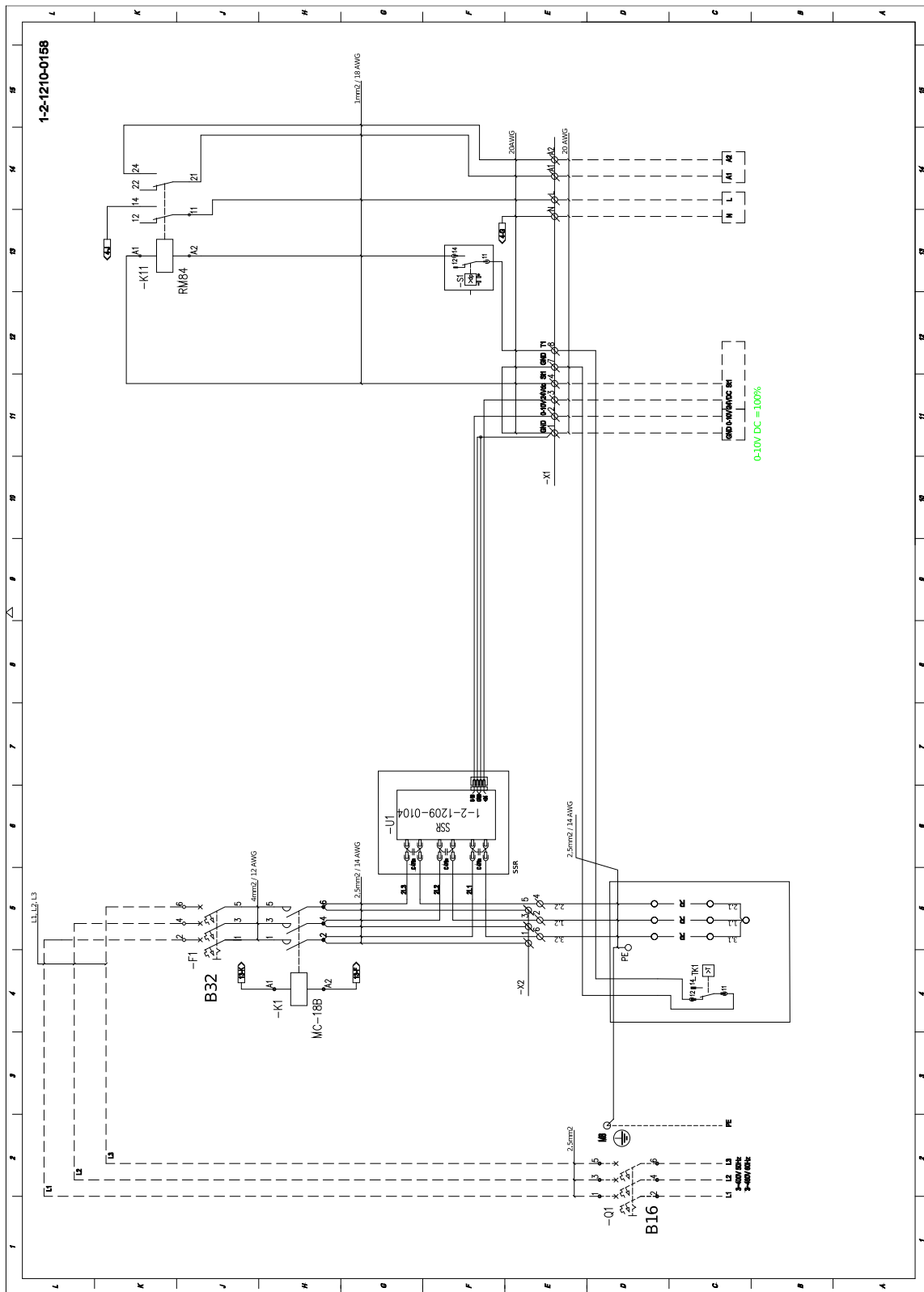

10.3.2 LOW POWER – 6KW – VVS043c

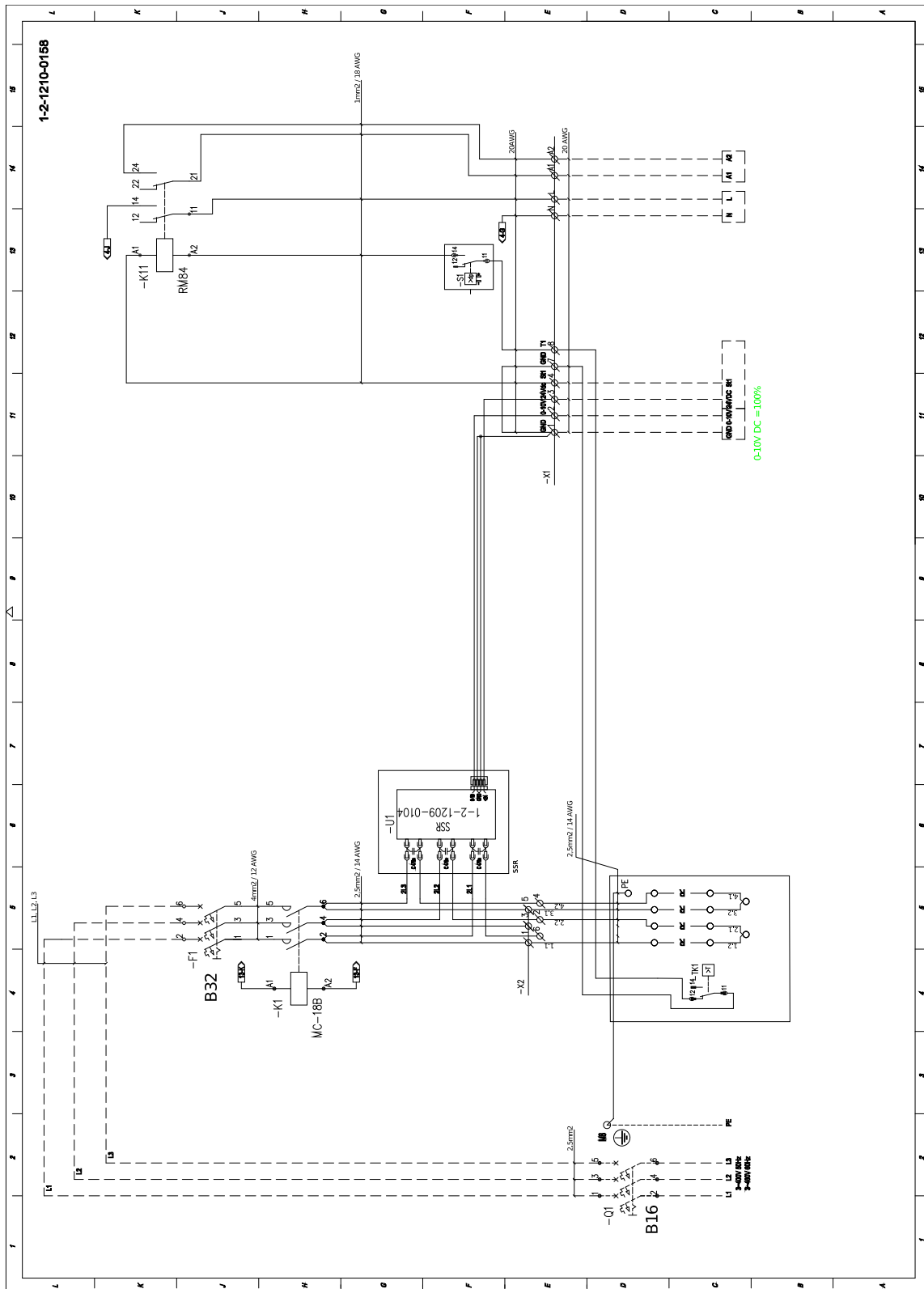

10.3.3 HIGH POWER – 18KW – VVS023c, VVS033c

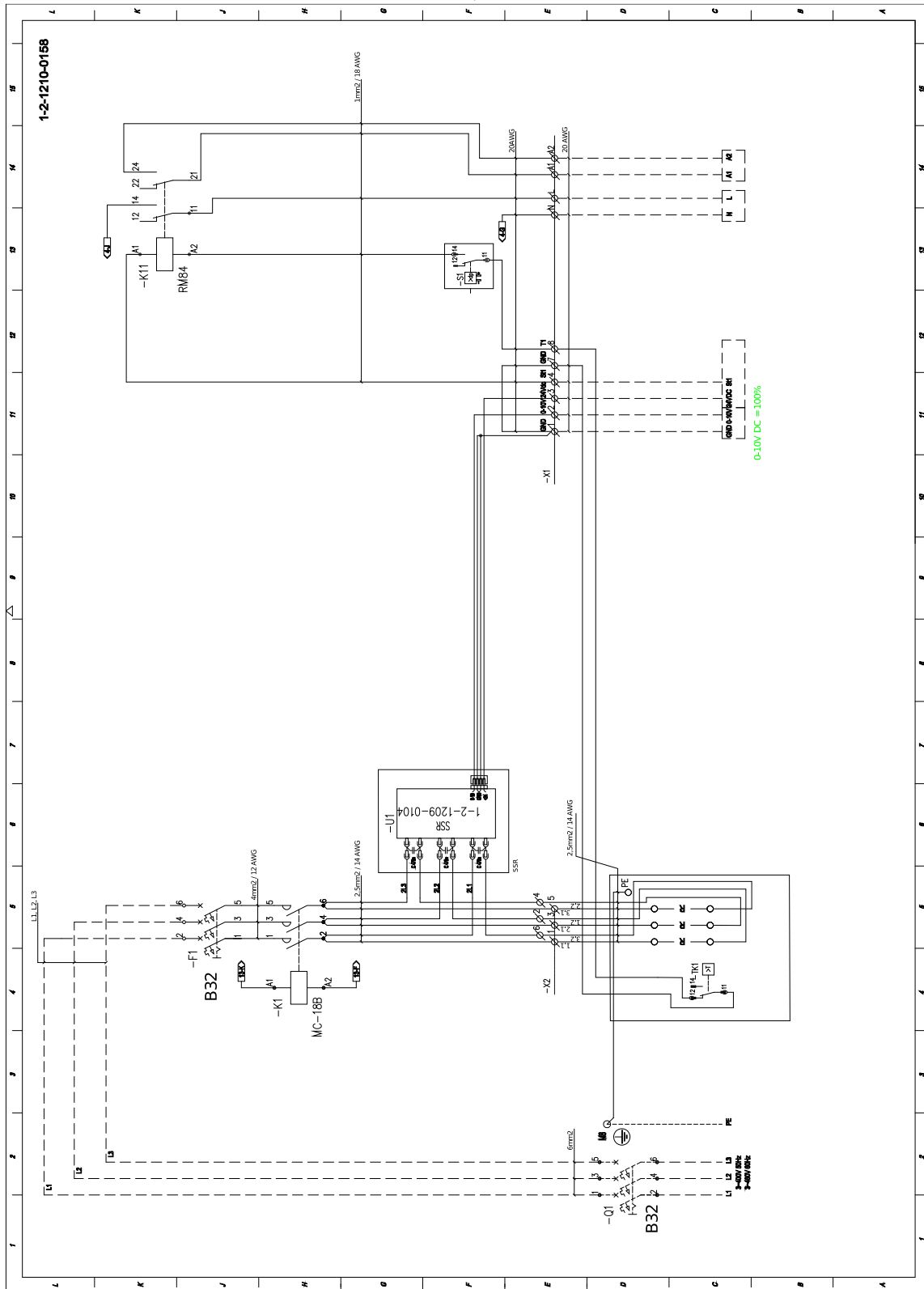

10.3.5 HIGH POWER – 36KW – VVS023c, VVS033c

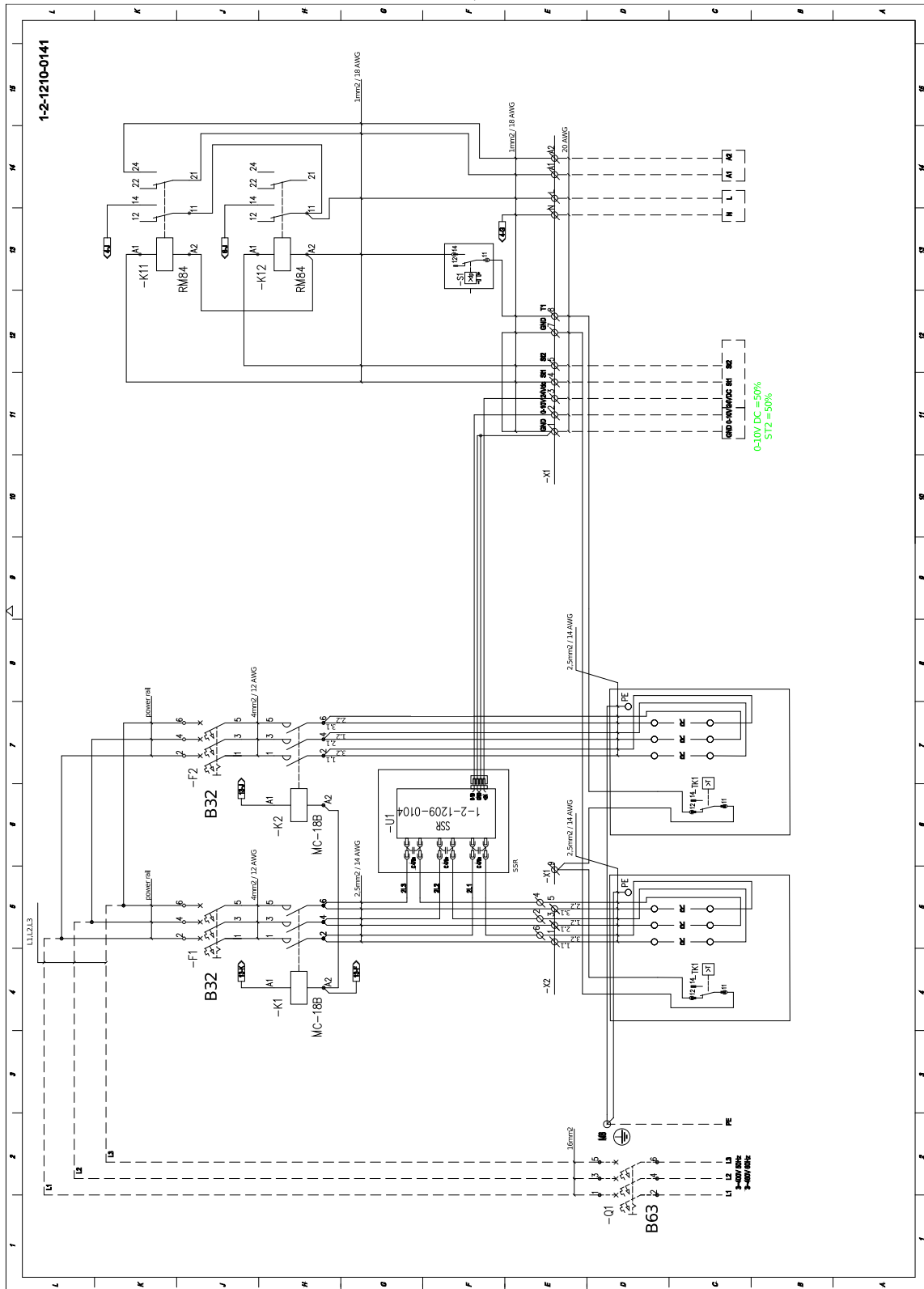

10.3.6 HIGH POWER – 48KW – VVS043c

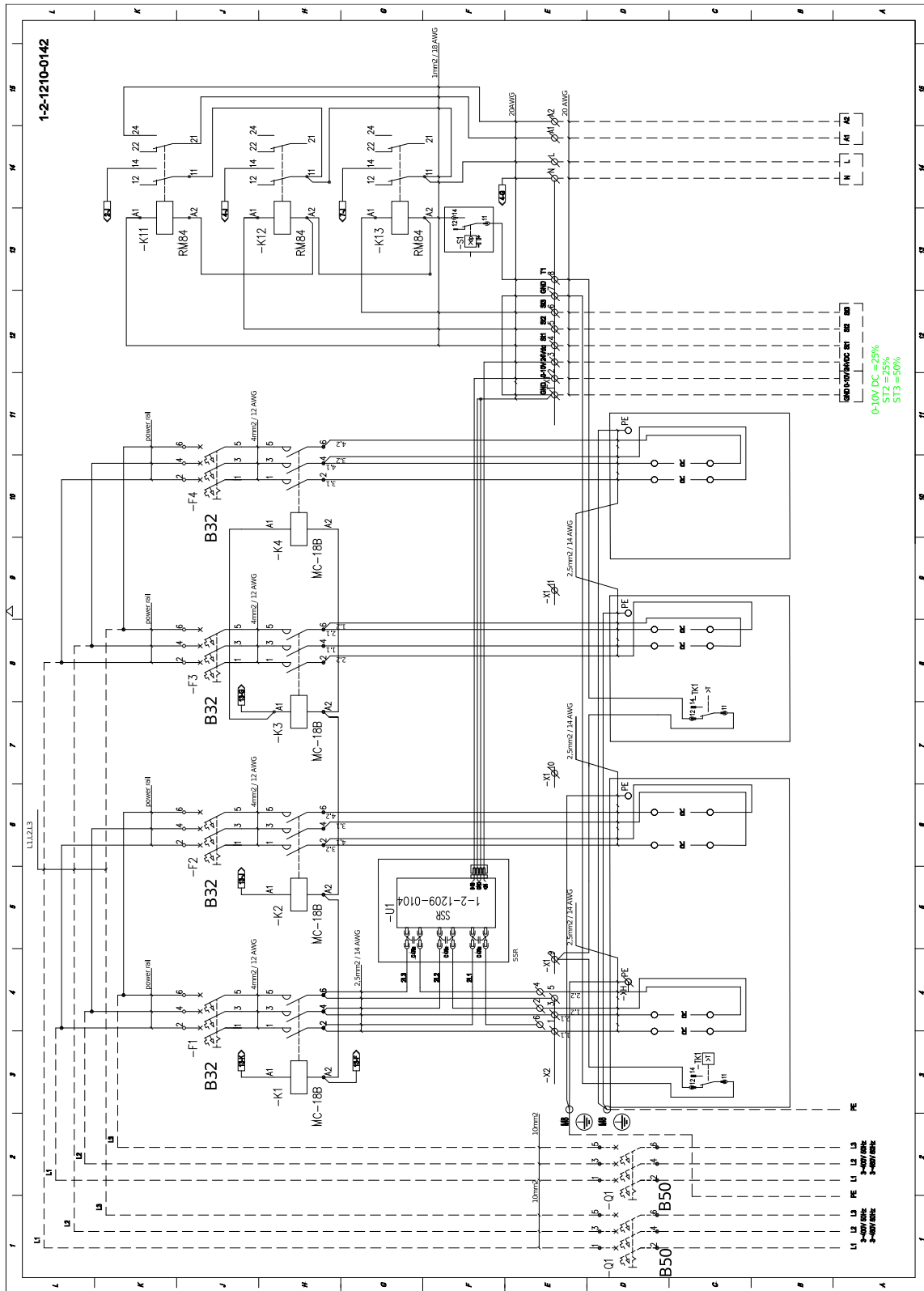

10.3.7 HIGH POWER – 72KW – VVS043c

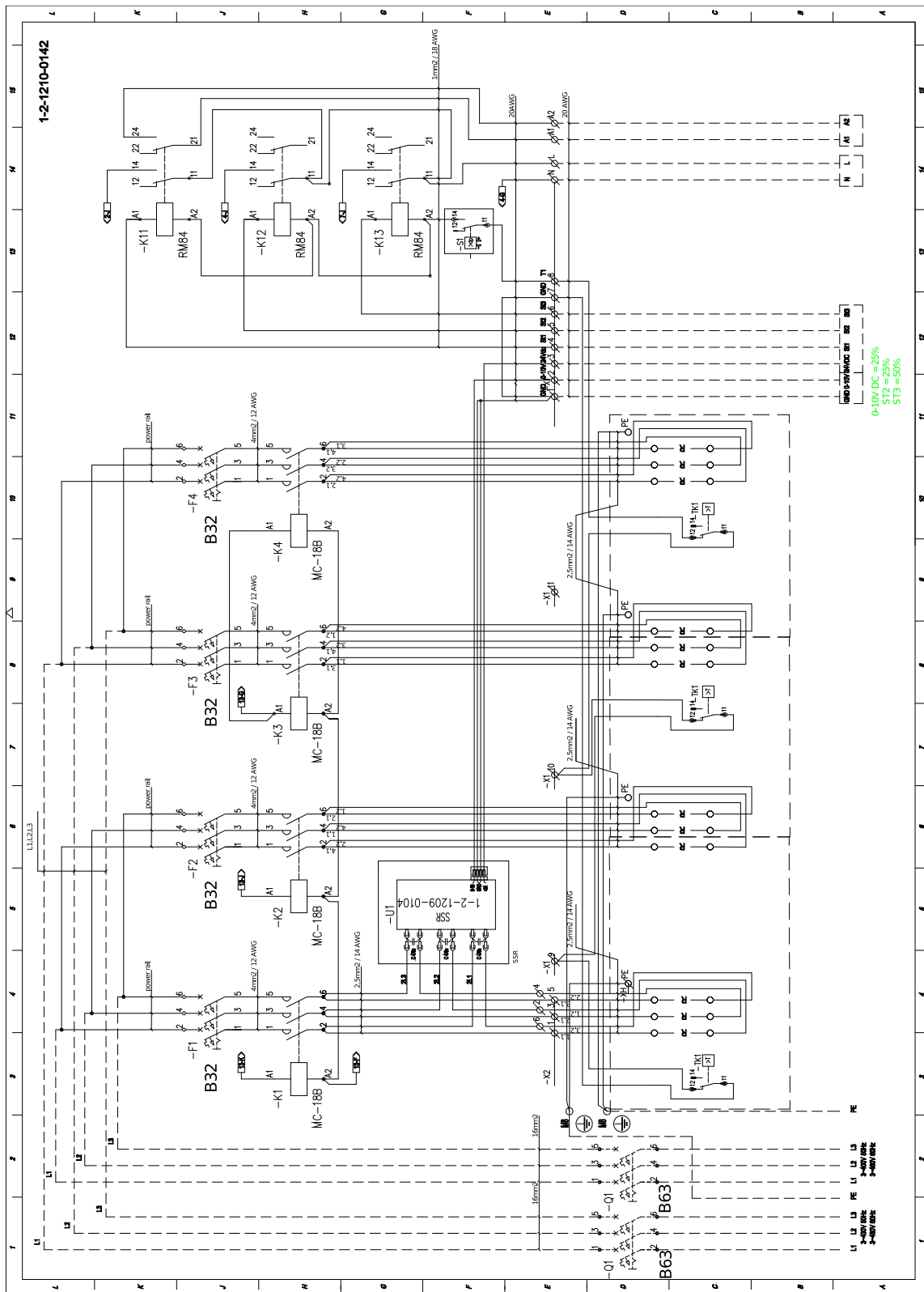

10.3.8 HIGH POWER – 54KW – VVS033c

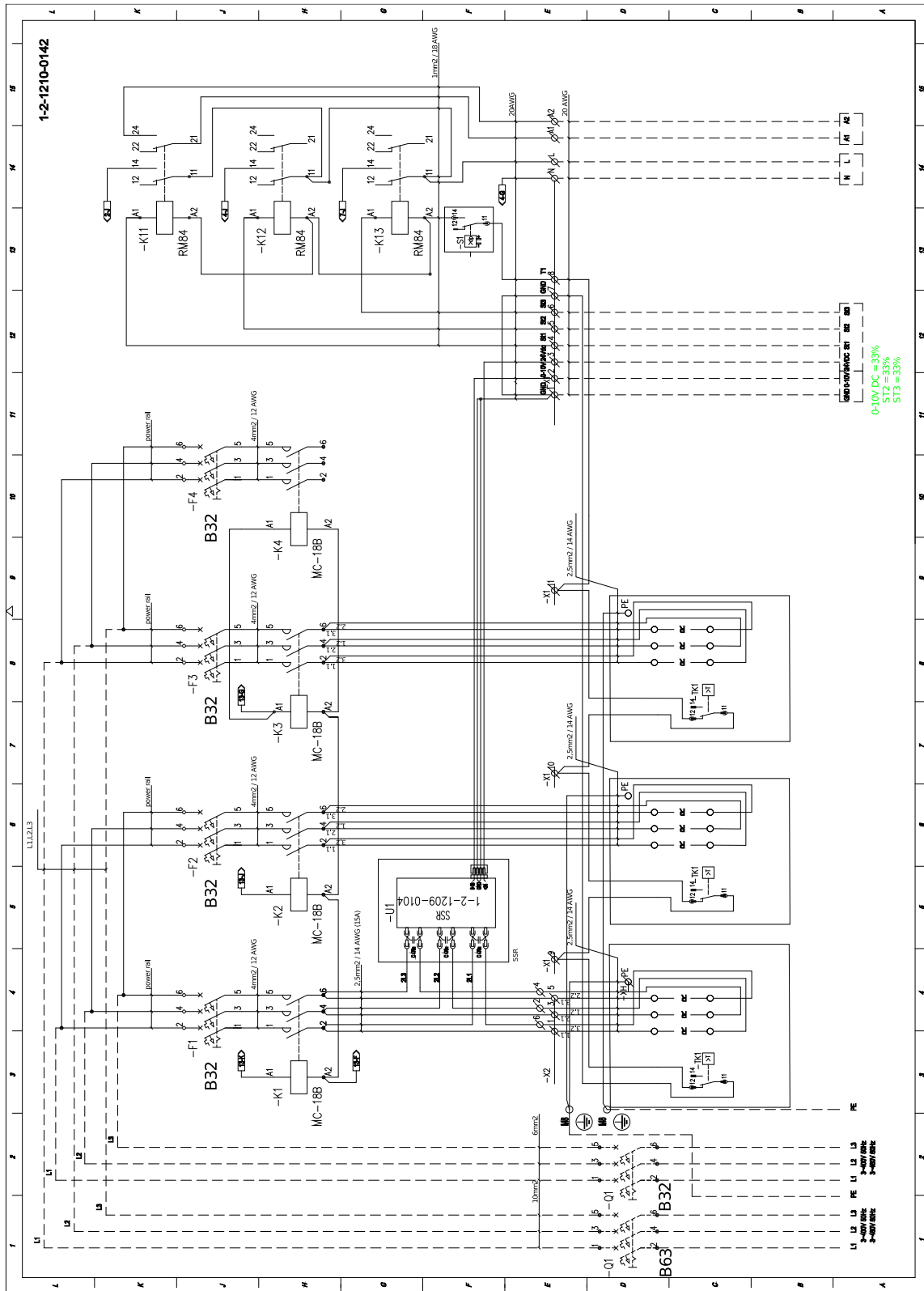

10.4 UNIT WIRING DIAGRAM

10.4.1 PLUG&PLAY HEX (1/4)

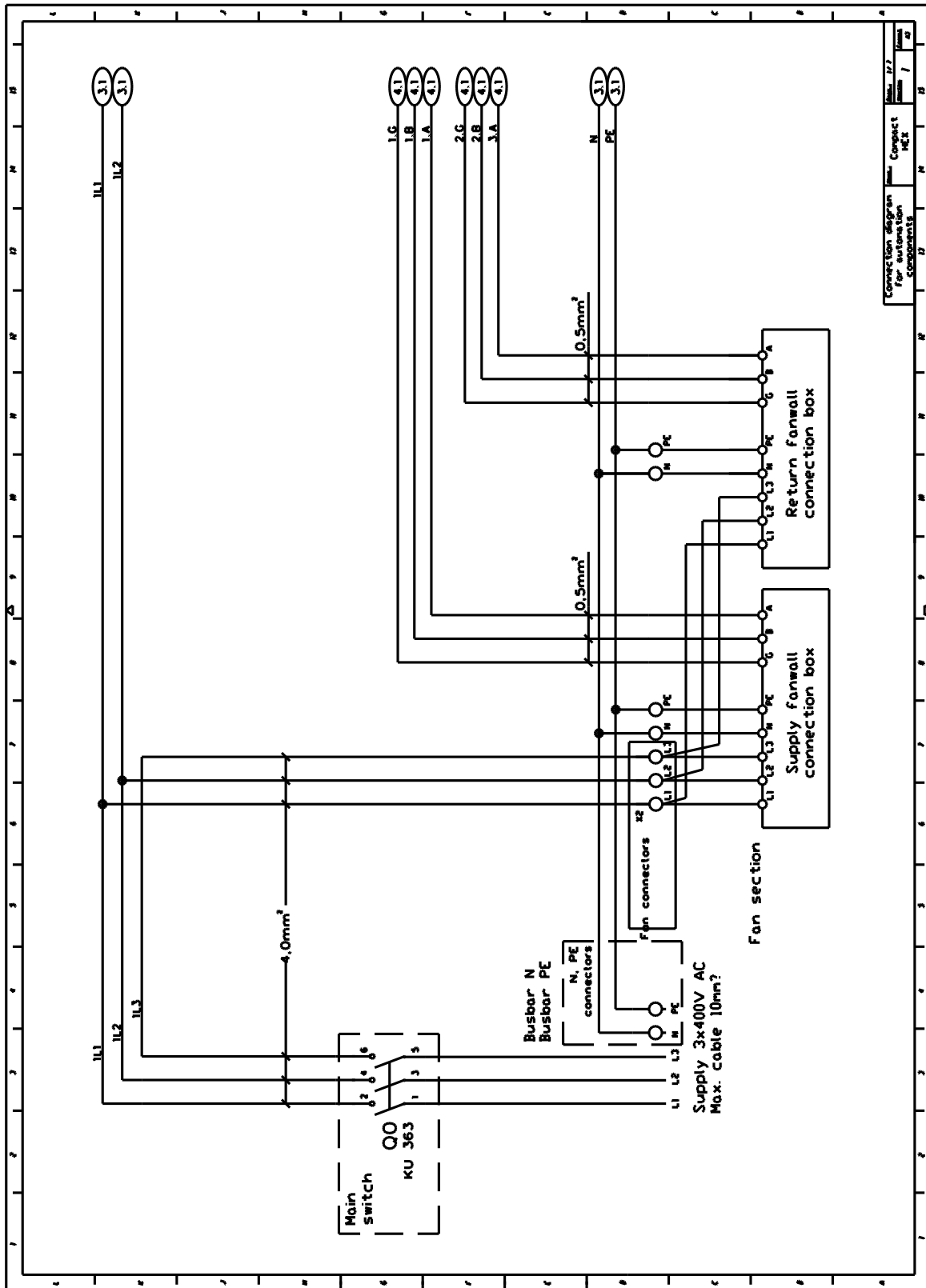

10.4.2 PLUG&PLAY HEX (2/4)

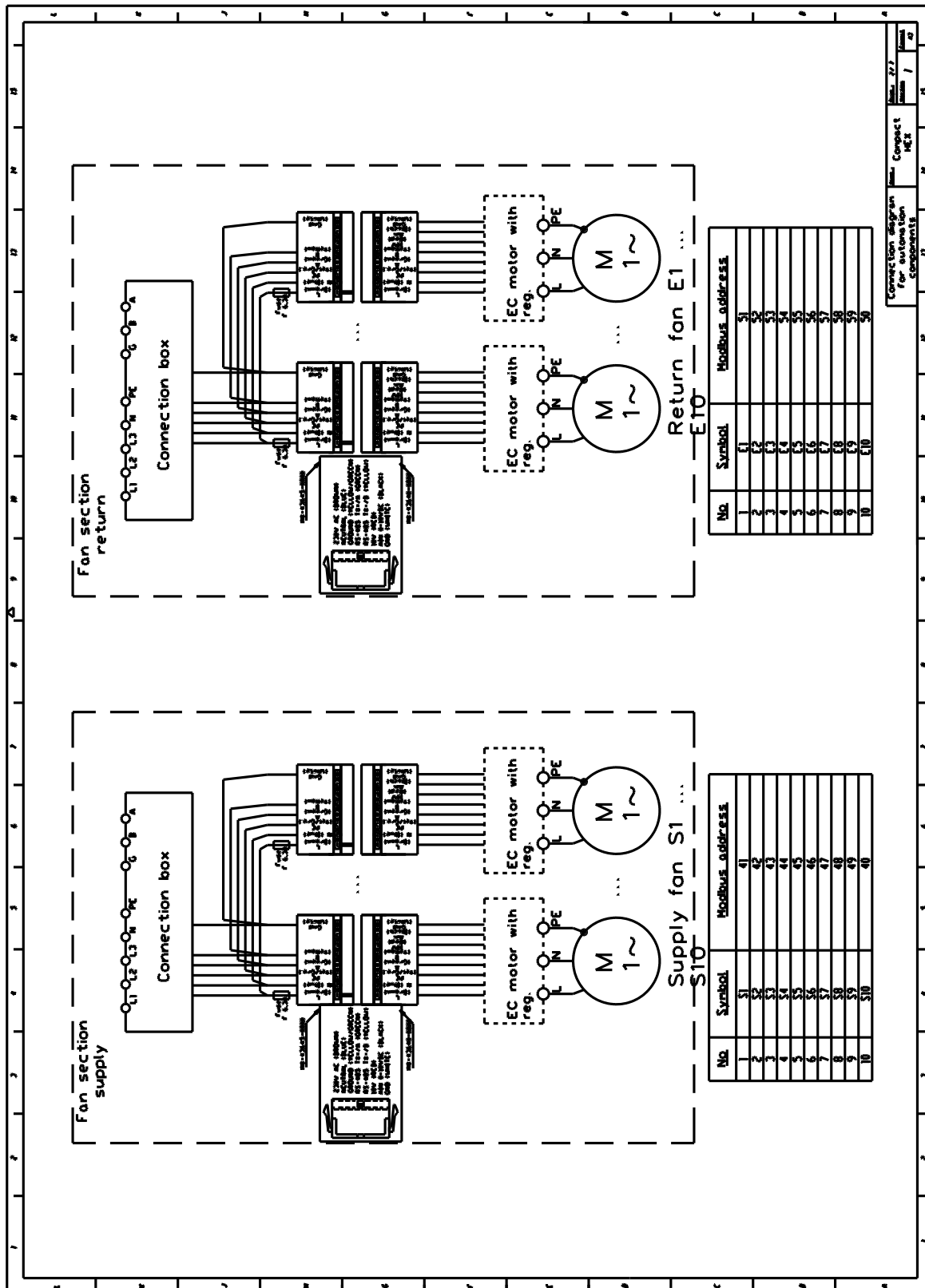

10.4.3 PLUG&PLAY HEX (3/4)

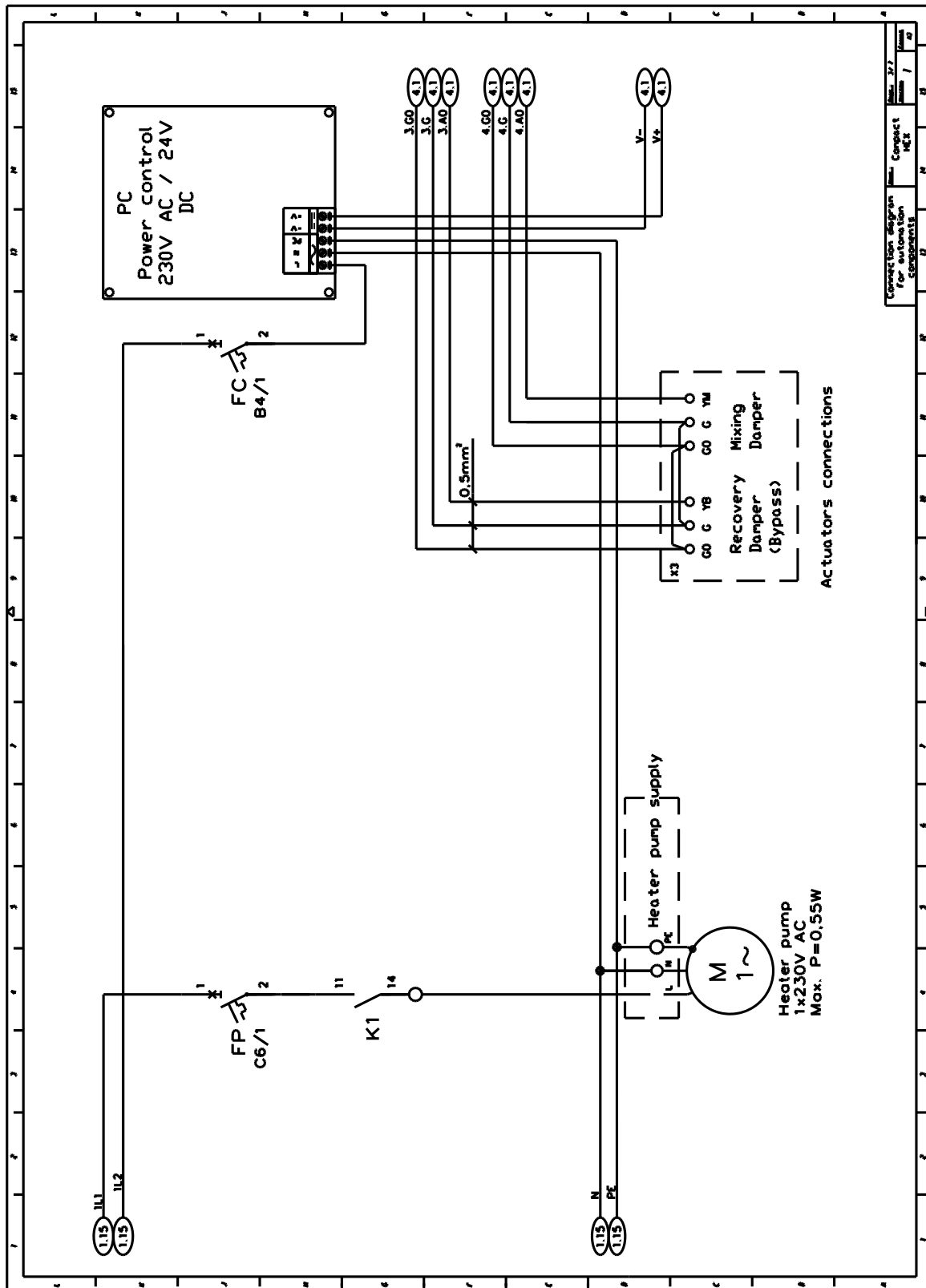

10.4.4 PLUG&PLAY HEX (4/4)

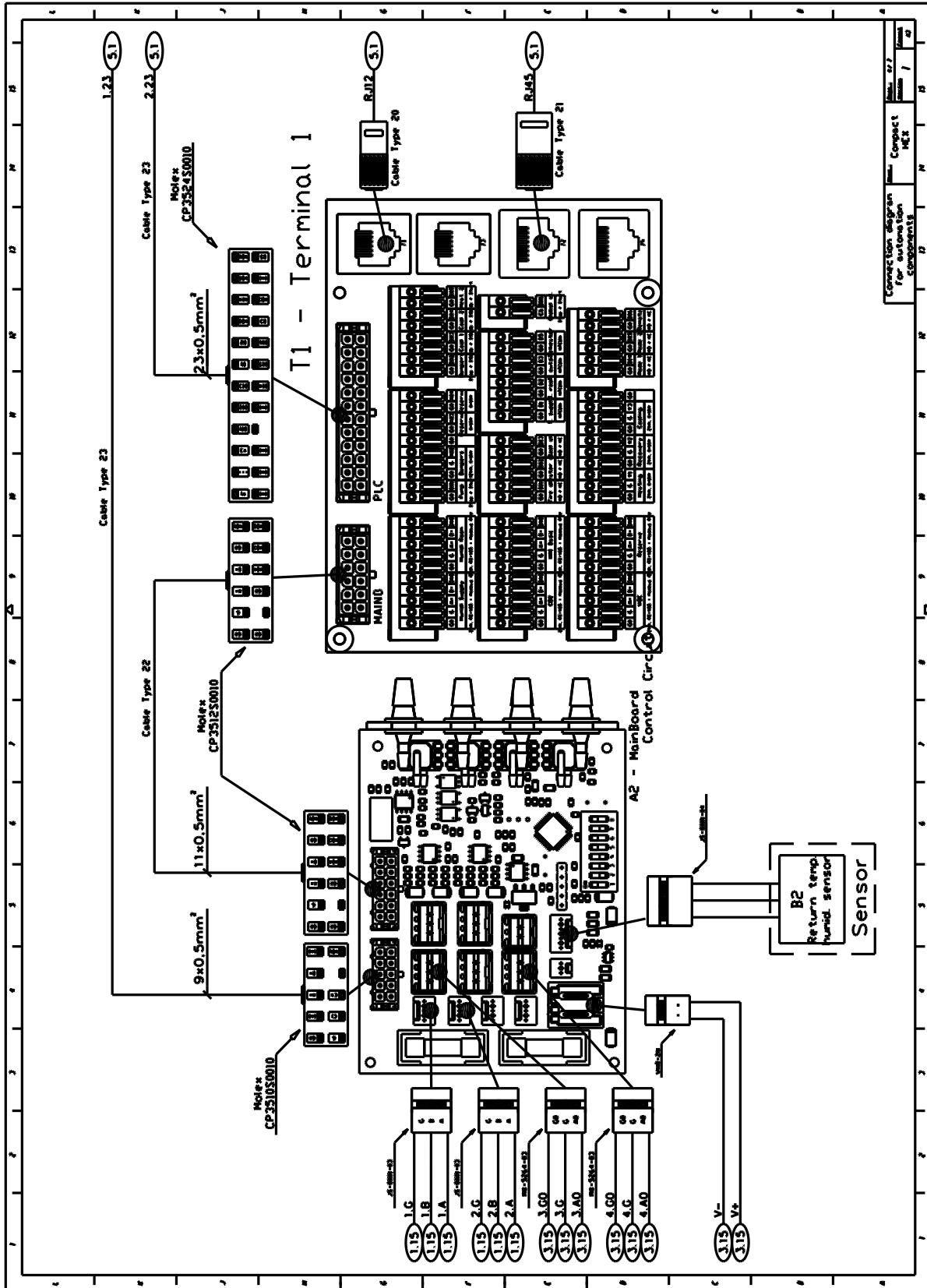

11 SUPPLEMENTARY INFORMATION

11.1 TECHNICAL INFORMATION FOR REGULATION (EU) N327/2011 IMPLEMENTING DIRECTIVE 2009/125/EC.

Model:	19/0,16 EC	22/0,37 EC	22/0,75 EC	25/0,37 EC	25/0,75 EC
1.	60,2	60,8%	60,8%	60,8%	60,1%
2.	A	A	A	A	A
3.	Static	Static	Static	Static	Static
4.	62	62	62	62	62
5.	Yes	Yes	Yes	Yes	Yes
6.	2018	2018	2018	2018	2018
7.	VTS, Poland	VTS, Poland	VTS, Poland	VTS, Poland	VTS, Poland
8.	1-2-0294-1750	1-2-0294-1547	1-2-0294-1548	1-2-0205-4001	1-2-0205-4003
9.	169W, 540m ³ /h, 450Pa	370W, 1300m ³ /h, 700Pa	750W, 1550m ³ /h, 1150Pa	370W, 1550m ³ /h, 620Pa	750W, 1950m ³ /h, 1000Pa
10.	4030RPM	3600RPM	4500RPM	3000RPM	3800RPM
11.	1	1	1	1	1
12.	<ul style="list-style-type: none"> • Demontaż urządzenia musi być przeprowadzany i/lub nadzorowany przez wykwalifikowany personel o odpowiedniej wiedzy specjalistycznej. • Należy się skontaktować z pobliską firmą, uprawnioną (certyfikowaną) do usuwania odpadów. Należy ustalić, jakie są oczekiwania odnośnie jakości demontażu maszyny i postanowień odnośnie podzespołów. • Urządzenie należy demontować w oparciu o ogólne procedury, powszechnie stosowane w inżynierii mechanicznej. <p>OSTRZEŻENIE</p> <ul style="list-style-type: none"> • Części maszyny mogą spadać / upaść. Urządzenie jest wykonane z ciężkich podzespołów. Podzespoły te mogą upaść podczas demontażu. Niekontrolowany upadek części grozi śmiercią, poważnymi urazami lub uszkodzami materiałowymi. • Należy przestrzegać zasad bezpieczeństwa: <ul style="list-style-type: none"> ○ 1. Odłączyć wszystkie połączenia elektryczne ○ 2. Zabezpieczyć przed przypadkowym ponownym włączeniem. ○ 3. Upewnić się, że urządzenia nie są pod napięciem. ○ 4. Osłonić lub odizolować pobliskie podzespoły, które są nadal pod napięciem. • Przy podłączaniu energii elektrycznej do systemu należy zastosować odwrotną kolejność postępowania. • Podzespoły: urządzenia te składają się w większości ze stali z różnym udziałem części ze stopów miedzi, stopów aluminium i z tworzyw sztucznych (wirnik wykonany z materiału SAN - styrenu, akrylonitrylu - materiału konstrukcyjnego z zawartością 20% włókna szklanego). Metale są zasadniczo uznawane za materiały bez ograniczeń w recyklingu. • Należy wysortować podzespoły do recyklingu, zależnie od tego czy są one: żeliwne, stalowe, aluminiowe, nieżelazne, np. izolacja uzwojeń zostaje spopieleną w trakcie recyklingu miedzi, materiały izolacyjne, kable i przewody, odpady elektroniczne, części z tworzywa (wirniki, osłony uzwojeń, itd.). To samo dotyczy ściereczek i substancji czyszczących, które były stosowane podczas prac przy maszynie. Wydzielone podzespoły należy usuwać, zgodnie z lokalnymi przepisami lub za pośrednictwem wyspecjalizowanego przedsiębiorstwa ds. przyjmowania odpadów. 				
13.	<ul style="list-style-type: none"> • Długotrwała, bezawaryjna praca urządzenia zależy od przestrzegania ograniczeń roboczych i wydajnościowych dla wyrobu/urządzenia/wentylatora, zgodnie z instrukcją doboru lub podręcznikiem konserwacji. • Dla uzyskania właściwego działania urządzeń należy się dokładnie zapoznać z treścią podręcznika konserwacji, zwracając szczególną uwagę na rozdziały „Instalacja”, „Rozruch” i konserwacja. 				
14.	Brak dodatkowych elementów				

SR-FS FANS							
Fan Set Model	#2	#5	#9-1	#9-2	#9-3	#10	#11
	[%]	[%]	[-]	[kW]	[m³/h].	[Pa]	[rpm]
SR-FS-P-225-0.3	65,40	73,30	SR-FS-P-225-0.3	0,43	1 288	704	3 600
SR-FS-P-225-0.7	62,00	68,10	SR-FS-P-225-0.7	0,85	1 642	1 065	4 500
SR-FS-P-250-0.3	66,20	73,30	SR-FS-P-250-0.3	0,49	1 676	633	3 000
SR-FS-P-250-0.7	67,40	72,40	SR-FS-P-250-0.7	0,98	2 060	1 058	3 800
SR-FS-P-315-0.3	65,40	72,70	SR-FS-P-315-0.3	0,49	2 256	461	2 060
SR-FS-P-315-0.7	66,20	72,00	SR-FS-P-315-0.7	0,75	2 411	674	2 400
SR-FS-P-315-1.5	69,70	73,00	SR-FS-P-315-1.5	1,77	3 560	1 164	3 250
SR-FS-P-315-2.5	67,80	70,40	SR-FS-P-315-2.5	2,44	3 964	1 419	3 600
SR-FS-A-225-0.3	62,70	71,10	SR-FS-A-225-0.3	0,41	1 238	674	3 600
SR-FS-A-225-0.7	59,70	66,20	SR-FS-A-225-0.7	0,83	1 527	1 069	4 500
SR-FS-A-250-0.3	62,40	70,00	SR-FS-A-250-0.3	0,48	1 456	672	3 000
SR-FS-A-250-0.7	65,20	70,60	SR-FS-A-250-0.7	0,93	2 111	950	3 800
SR-FS-A-315-0.3	62,30	70,20	SR-FS-A-315-0.3	0,46	2 119	437	2 060
SR-FS-A-315-0.7	64,40	70,60	SR-FS-A-315-0.7	0,71	2 296	648	2 400
SR-FS-A-315-1.5	67,60	71,30	SR-FS-A-315-1.5	1,69	3 428	1 118	3 250
SR-FS-A-315-2.5	67,10	69,90	SR-FS-A-315-2.5	2,33	3 902	1 363	3 600
SR-FS-A-355-1.6	70,00	73,60	SR-FS-A-355-1.6	1,65	4 017	967	2 650
SR-FS-A-355-2.5	69,90	72,20	SR-FS-A-355-2.5	2,50	4 513	1 316	3 000
SR-FS-A-355-3.7	66,90	68,40	SR-FS-A-355-3.7	3,57	5 199	1 573	3 400
SR-FS-A-400-1.6	70,70	73,70	SR-FS-A-400-1.6	1,89	4 876	920	2 250
SR-FS-A-400-2.5	68,40	71,00	SR-FS-A-400-2.5	2,41	6 366	879	2 000
SR-FS-A-400-3.7	66,70	67,90	SR-FS-A-400-3.7	3,83	5 836	1 499	2 850
SR-FS-A-400-5.4	66,70	66,70	SR-FS-A-400-5.4	5,65	6 802	1 916	3 250
SR-FS-A-450-1.6	70,20	73,60	SR-FS-A-450-1.6	1,75	5 176	798	1 800
SR-FS-A-450-2.5	68,10	71,00	SR-FS-A-450-2.5	2,24	5 068	1 021	2 400
SR-FS-A-450-3.7	67,70	69,20	SR-FS-A-450-3.7	3,57	7 086	1 170	2 300
SR-FS-A-450-5.4	66,80	67,10	SR-FS-A-450-5.4	5,29	8 021	1 526	2 600
SR-FS-A-500-3.7	69,80	71,20	SR-FS-A-500-3.7	3,59	8 577	1 001	1 900
SR-FS-A-500-5.4	70,10	70,50	SR-FS-A-500-5.4	5,06	9 562	1 284	2 130
SR-FS-A-560-3.7	69,00	70,40	SR-FS-A-560-3.7	3,58	9 486	893	1 600
SR-FS-A-560-5.4	69,00	69,00	SR-FS-A-560-5.4	5,52	11 192	1 176	1 830
WG PARAMETER (EU) 327/2011	VALUE						
#3	A						
#4	Static						
#6	Year of manufacture printed on the product nameplate.						
#7	Swiss Rotors sp. z o.o. , 586-001-73-79 , Rumska 18, 81-198, Dębogórze, Poland						
#8	YES						
#12	Disposal shall be carried out in a suitable and environmentally friendly manner in accordance with the legal regulations of the country concerned. "Materials are sorted and segregated in an environmentally friendly manner." If necessary, they should be taken to a specialist facility.						
#13	Information provided in the relevant chapters of the dedicated manual, especially on maintenance (www. https://swissrotors.com)						
#14	N/A						

11.2 ASSOCIATED INSTRUCTIONS



! Refer to the detailed instructions and make the connections and configurations according to the documentation available at www.vtsgroup.com and the instructions supplied with the equipment. In particular, you should familiarise yourself with:

- Installation, Operation and Maintenance Manual - VENTUS Software - uPC3 control / VTS Ventilation Software for air handling units (Ventus - Application uPC3) uPC3 controller - connection diagram,
- Installation Manual Sections Connection,
- Installation, Operation and Maintenance Manual Vts Ec Motor Drive / Technical terms and conditions for drives with EC motors for VTS units,
- Operation and Maintenance manual - Electric Heaters - Power Slices / Electric Heaters - Slices Technical and Operational Documentation.
- Others available at www.vtsgroup.com
- AHU uPC3 Controller Masks Description

11.3 DESCRIPTION OF UPC3 CONTROLLER SCREENS

A full description of the uPC3 controller screens is available in the dedicated manual "AHU uPC3 Description of uPC3 Controller Screens".

11.4 DISMANTLING AND DISPOSAL OF AHU



- ! The dismantling of the appliance should be carried out and/or supervised by suitably qualified personnel with the appropriate level of knowledge and authority. A certified waste disposal organisation in your region should be contacted. Confirm how to prepare and segregate materials, especially hazardous materials that may have been used in the construction of the appliance (e.g. batteries).
- ! Components should be sorted with a view to recycling by material: iron and steel, aluminium, copper, non-ferrous metals e.g. windings (winding insulation will be burned off when copper is recycled), insulating materials, electrical wiring, electronic waste, plastic components, etc. The same applies to fabrics and cleaning substances that have been used during component dismantling. The separation of components should be carried out according to local regulations or by a specialised recycling firm.
- ! The unit should be dismantled using general procedures commonly used in mechanical engineering, respecting local regulations for disposal and waste management.
- ! Low-moisture (CFC) installations are filled with refrigerant, usually R41A, which cannot escape into the atmosphere. The refrigerant must be recovered in accordance with the regulations in force (this operation must be carried out by a qualified person).

GENERAL DISMANTLING PROCEDURE

- Disconnection of all utilities.
- Removal of polite and refrigerants from the installation.
- Dismantling of inspection panels.
- Dismantling of electrical and Control systems.
- Removal of all accessories and components from the control panel.
- Disassembly of components according to their material of construction.
- Case dismantling.
- Separation of insulation from sheet metal.
- Segregation of materials and components by material.
- Transfer of materials for disposal.



- ! General safety rules must be observed.
- ! In particular, it is important to bear in mind:
 - The weight of the appliance and its components. The appliance consists of heavy components. These parts may fall during disassembly, which may cause death, serious personal injury or material damage.
 - Disconnection of the supply voltage including all associated systems.
 - Prevention of accidental re-engagement.
 - The presence of Control or electronic components in which electricity can be stored.

11.5 NOTES

Routine checks, carried out by qualified technical personnel or service personnel authorised by VTS, guarantee long-term, reliable and trouble-free operation of the equipment. Our service staff is available at all times to provide support for commissioning, maintenance and in the event of any emergency situation relating to the operation of the unit.

VTS authorised service sells spare parts and accessories for our air handling units. When ordering parts, please specify the type of air handling unit, size and series number.

For more information on the VTS service network, visit: www.vtsgroup.com.



The unit's rating plate includes the sound pressure level LWA (1m) quoted for a distance of 1m from the unit.

To calculate the LWA values at 3m and 5m, use the formula:

- $LWA(3m) = LWA(1m) - 9.54$
- $LWA(5m) = LWA(1m) - 13.98$



Original version of the manual is in PL language.
The documentation was translated into English by machine.
VTS reserves the right to make changes without notice

11.6 EU DECLARATION OF CONFORMITY

DEKLARACJA ZGODNOŚCI UE / EU DECLARATION OF CONFORMITY

My Producent: / <i>The Manufacturer:</i>	VTS Sp. z o.o. ul. Aleja Grunwaldzka 472A 80e-309 Gdańsk, Poland	
Strona internetowa / <i>Website:</i>	www.vtsgroup.com	
Modele / <i>Models:</i>	VENTUS COMACT VVS021c, VVS030c, VVS040c, VVS055c, VVS075c, VVS100c, VVS120c, VVS150c	
Rok produkcji <i>Year of manufacture:</i>	Podano na tabliczce znamionowej urządzenia	
Numer seryjny 8-XXX-XX-XXXXX-XXXXX <i>Serial number:</i>	Podano na tabliczce znamionowej urządzenia	

DYREKTYWY / *DIRECTIVES*

2006/42/WE Dyrektywa maszynowa
2006/42/EC Machinery Directive

2009/125/WE Dyrektywa Ekoprojektu
2009/125/EC Ecodesign Directive

2014/30/UE Dyrektywa kompatybilności
elektromagnetycznej
2014/30/EU EMC Directive

2011/65/UE, 2015/863/UE Dyrektywa RoHS
2011/65/EU, 2015/863/EU RoHS Directive

2014/35/UE Dyrektywa niskonapięciowa
2014/35/EU Low Voltage Directive

STANDARDY I SPECYFIKACJE / *STANDARDS AND SPECIFICATIONS*

EN ISO 12100:2010 | EN ISO 13857:2019 | EN 60204-1:2018 | EN 60335-1:2012 | EN 60335-2-40:2024 | EN 50106:2008 | EN 60529::1991+A1:2000+A2:2013

327/2011 | 1253/2014 | EN 13053:2019

EN 62233:2008 | EN 61000-6-2:2019 | EN 61000-6-3:2021

EN IEC 63000:2018