



EN

CE

Installation, Operation & Maintenance Manual

Suspended air conditioning and ventilation units

VENTUS

Contents

1	GENERAL INFORMATION	5
2	PRIOR TO INSTALLATION	10
2.1	TRANSPORTATION AND STORAGE	10
2.2	PREPARATION FOR INSTALLATION	12
2.2.1	LOCATION OF THE DEVICE	13
2.2.2	INSTALLATION OF A DUCTED OVERHEAD PANEL	13
2.2.3	CONNECTING AIR DUCTS	21
3	CONNECTION OF HEAT EXCHANGERS	22
3.1	CONNECTION OF WATER EXCHANGERS	22
3.2	CONNECTION OF DX (DIRECT EXPANSION COILS) EXCHANGERS	24
3.3	CONDENSATE DRAINAGE	25
4	CONNECTION OF ELECTRICAL POWER TO THE CONTROL PANEL	26
4.1	PLUG&PLAY VERSION CONNECTION	26
4.2	CONNECTING VERSIONS WITHOUT FACTORY WIRING	27
5	ELECTRIC HEATER	30
5.1	BUILT IN ELECTRIC HEATER (PTC)	30
5.2	DUCTED ELECTRIC HEATER	31
5.2.1	GENERAL INFORMATION	31
5.2.2	HEATER POWER SUPPLY CONNECTION AND CURRENT PROTECTION	34
5.2.3	THERMAL SWITCH (THERMIC)	38
5.2.4	DIFFERENTIAL PRESSURE SWITCH	39
5.2.5	CONNECTION OF ELECTRIC HEATER CONTROL	40
6	PLUG&PLAY COMPONENTS	43
6.1	STANDARD EQUIPMENT WITH FACTORY-MOUNTED CONTROL ELEMENTS	44
6.2	CONNECTION TERMINAL 1 (T1)	45
6.3	CABLE STANDARDS	46
6.4	ANALOG INPUTS (NTC10K)	47
6.4.1	SUPPLY AIR TEMPERATURE SENSOR B1	48
6.4.2	TOUCHSCREEN WATER HEATER TEMPERATURE SENSOR B5	49
6.5	DIGITAL INPUTS	50
6.5.1	FIRE ALARM SIGNAL DI1	51
6.5.2	DI2 WATER HEATER FREEZE SENSOR	51

6.5.3	DI3 COOLING SOURCE ALARM	52
6.6	ANALOG OUTPUTS (0-10V DC)	53
6.6.1	WATER MAIN HEATER VALVE ACTUATOR AND ELECTRIC MAIN HEATER CONTROL SIGNAL Y1	54
6.6.2	ACTUATOR OF THE WATER PREHEATER OR SECONDARY HEATER VALVE AFTER DX-H Y1 54	
6.7	DIGITAL OUTPUTS (24V DC)	55
6.8	CONNECTION OF CONDENSING UNIT SIGNALS.....	56
6.9	CONNECTION OF THREE-WAY VALVES.....	57
6.10	MODBUS RTU RS485 COMMUNICATION	58
6.11	CONNECTION OF OPERATOR PANELS	59
6.11.1	HMI ADVANCED.....	59
6.11.2	HMI BASIC.....	60
6.11.3	WebHMI AND VMS.....	61
6.11.4	BLUETOOTH MODULE	62
7	INITIAL START-UP OF THE DEVICE	66
7.1	PREPARING FOR THE FIRST LAUNCH	66
7.1.1	CHECK THE CONDITION OF THE INSTALLATION	66
7.1.2	CONFIGURATION OF DX AND DX-H (REVERSIBLE) EXCHANGERS.....	68
7.1.3	POWER CONFIGURATION OF ELECTRIC HEATERS	70
7.2	INITIAL START-UP	71
7.2.1	FACTORY PARAMETERS	71
7.2.2	CONTROL PANELS.....	73
7.2.3	HMI ADVANCED.....	74
7.2.4	HMI BASIC 2HY	76
7.2.5	mHMI APPLICATION	80
7.2.6	OPERATING MODES OF THE CONTROL PANEL.....	87
7.2.7	VERIFICATION OF OPERATION DURING INITIAL START-UP	88
7.2.8	MEASUREMENT OF AIR VOLUME.....	90
7.2.9	THE MOST COMMON ADAPTIVE CHANGES OF PARAMETERS TO THE NEEDS OF THE FACILITY	92
8	MAINTENANCE	95
8.1	MAINTENANCE	95
8.2	CONSUMABLES – AIR FILTERS	103
8.2.1	AIR FILTERS	103
8.3	OTHER SPARE PARTS	104

8.3.1	WATER EXCHANGERS	104
8.3.1	DX EXCHANGERS.....	105
9	WIRING DIAGRAMS	106
9.1	DUCTED ELECTRIC HEATER WIRING DIAGRAMS	106
9.1.1	HEATER - LOW POWER - 2.5KW - VVS005 s	106
9.1.2	HEATER - LOW POWER - 3KW - VVS010 s	107
9.1.3	HEATER - LOW POWER - 6KW - VVS015s - VVS030 s	108
9.1.4	HEATER - HIGH POWER - 10KW - VVS005 s.....	109
9.1.5	HEATER - HIGH POWER - 12KW - VVS010 s.....	110
9.1.6	HEATER - HIGH POWER - 18KW - VVS015s - VVS030 s.....	111
9.1.7	HEATER - HIGH POWER - 36KW - VVS015s - VVS030 s.....	112
9.2	VVS005s WITH INBUILT HE PTC.....	113
9.3	DEVICE CONNECTION DIAGRAM	116
9.3.1	PLUG&PLAY UNITS WITH HEX (1/6)	116
9.3.2	PLUG&PLAY UNITS WITH HE (2/6).....	117
9.3.3	PLUG&PLAY UNITS WITH HEX (3/6)	118
9.3.4	PLUG&PLAY UNITS WITH HEX (4/6)	119
9.3.5	PLUG&PLAY UNITS WITH HEX (5/6)	120
9.3.6	PLUG&PLAY UNITS WITH HEX (6/6)	121
9.4	HEALTH AND SAFETY INSTRUCTIONS	122
9.5	TECHNICAL INFORMATION TO REGULATION (U) N327/2011, IMPLEMENTING DIRECTIVE 2009/125/WE	123
9.6	ADDITIONAL INFORMATION.....	125

1 GENERAL INFORMATION

Thorough familiarization with the contents of this manual, as well as the installation, commissioning and operation of the air handling unit according to the instructions given and with observance of all health and safety regulations will guarantee a solid basis for efficient, safe and trouble-free operation of the unit.

This document does not cover all possible configurations of these devices, does not give all examples of their assembly and installation, nor does it discuss all aspects of their commissioning, operation, repair and maintenance. If the equipment is used in accordance with its design purpose, both this documentation and any other materials that come with the equipment supplied contain information intended only for qualified technical personnel.



- ! Installation, commissioning and servicing of air conditioning units and their equipment may involve certain safety hazards, hence requires certain knowledge and training.
- ! Equipment improperly installed, adjusted, or replaced by an unqualified person can become the cause of serious injury to individuals, or even their death. The above exempts the manufacturer from liability and warranty and guarantee benefits.
- ! When connecting, servicing and using air handling units, observe all precautions communicated by the manufacturer and those resulting from good practices in the scope of HVAC installations and equipment.
- ! Installation, maintenance and repair must be carried out by qualified technical personnel or their performance must be supervised by authorized professionals.
- ! By the term qualified technical personnel, we mean trained professionals who, through their professional experience, knowledge of the substantive related standards, documentation and regulations regarding operating procedures and related safety, are authorized to perform the necessary activities, and those who are able to diagnose and correct any potential problems.
- ! Warranty repairs of VTS air-conditioning units may be carried out only by service employees with authorization granted by VTS, confirmed by an appropriate certificate, allowing them to perform this kind of work. We also recommend that service personnel with authorization from VTS carry out installation, commissioning and perform post-warranty repairs, technical inspections and maintenance work required to be performed on air conditioning units.
- ! VTS reserves the right to make changes without prior notice.

Suspended air handling units (AHUs) VENTUS are designed for indoor installation. The design of these units is adapted to their suspension from the ceiling. The low height of the unit makes the air handling units fit perfectly in standard inter-ceiling spaces or spaces above the suspended ceiling. VENTUS VVS005s-VVS030s air handling units are designed to work with air duct systems supplying and extracting air from rooms according to the ventilation design. Duct connection provides no access to the rotating parts of the unit (fan impeller). Nominal parameters of the unit are presented in the unit selection sheet.



- ! OPENING THE INSPECTION PANELS, WHILE THE PANEL IS OPERATING, OR STARTING THE PANEL WITH THE INSPECTION PANELS OPEN IS STRICTLY PROHIBITED!
- ! BEFORE OPENING THE INSPECTION PANELS, TURN OFF THE CONTROL PANEL AND WAIT TWO MINUTES FOR ALL ELEMENTS IN MOTION TO STOP!
- ! DISCONNECT AND SECURE THE POWER SUPPLY TO PREVENT UNCONTROLLED STARTUP OF THE CONTROL PANEL!
- ! CONTROL SYSTEM IS REQUIRED TO ENSURE CONTROL OF OPTIMAL OPERATION OF THE DEVICE AND TO PROTECT THE DEVICE FROM FAILURE. CONTROL MUST INDICATE THE DEGREE OF DIRTINESS OF THE AIR FILTERS.

The device can be equipped with a number of functions and accessories, as well as an CONTROL system. The functions of the device and their parameters are given in the selection sheet generated from the manufacturer's information system according to the design guidelines.

Designation Functions	Function Name	Block length [mm].				
		VVS005s	VVS010s	VVS015s	VVS020s	VVS030s
F	Air filter	320	135	135	135	135
H (hw)	Water heater	320	220	220	220	220
C	Radiator	390	390	390	390	390
C(de)	Radiator with condenser	480	480	480	480	480
HC (cw)	Water heater and cooler	480-800	480-800	480-800	480-800	480-800
FPV	Counterflow heat exchanger , filter and fan	1350	1500	1500	1828	1828
FPVH	Counterflow heat exchanger , filter and fan, water heater					
V	Fan	390	480	480	480	480
FHV	Filter, water heater and fan	480	760	760	760	760

VENTUS VVS005s-VVS030s units have inspection panels located on the underside.

WIDTH AND HEIGHT OF THE BLOCKS

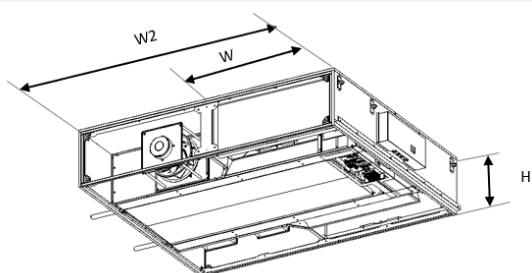

AHU	VVS 005s	VVS 010s	VVS 015s	VVS 020s	VVS 030s
W	385	595	795	825	1100
W2	770	1190	1590	1650	2200
H	400	400	400	490	490

INSPECTION PANELS - REMOVAL

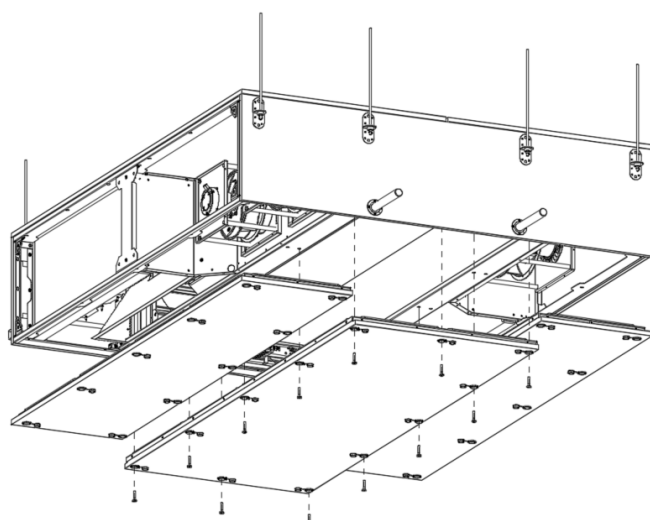

- ! Inspection panels are located on the underside.
- ! Disassembly of the panels is done by removing allen screws.
- ! Be very careful when unscrewing the inspection panels.
- ! As an option, the devices can be equipped with rails to prevent the panel from falling when unscrewed.

The units are made as right-sided or left-sided. The orientation of the unit is determined by the direction of airflow relative to the side of the unit where the heat exchanger connections are located. For supply and exhaust units, the version determines the direction of airflow in the supply section downstream of the heat recovery.

MARKING OF AIR INLET AND OUTLET

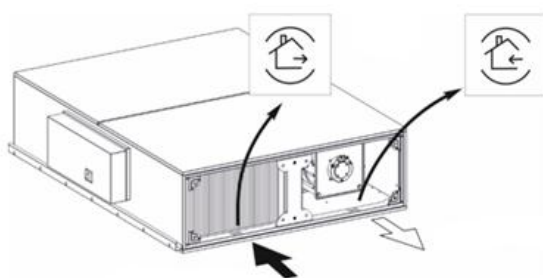

Exhaust air inlet



Supply air outlet to

RULE FOR DETERMINING THE EXECUTION SIDE OF THE DEVICE

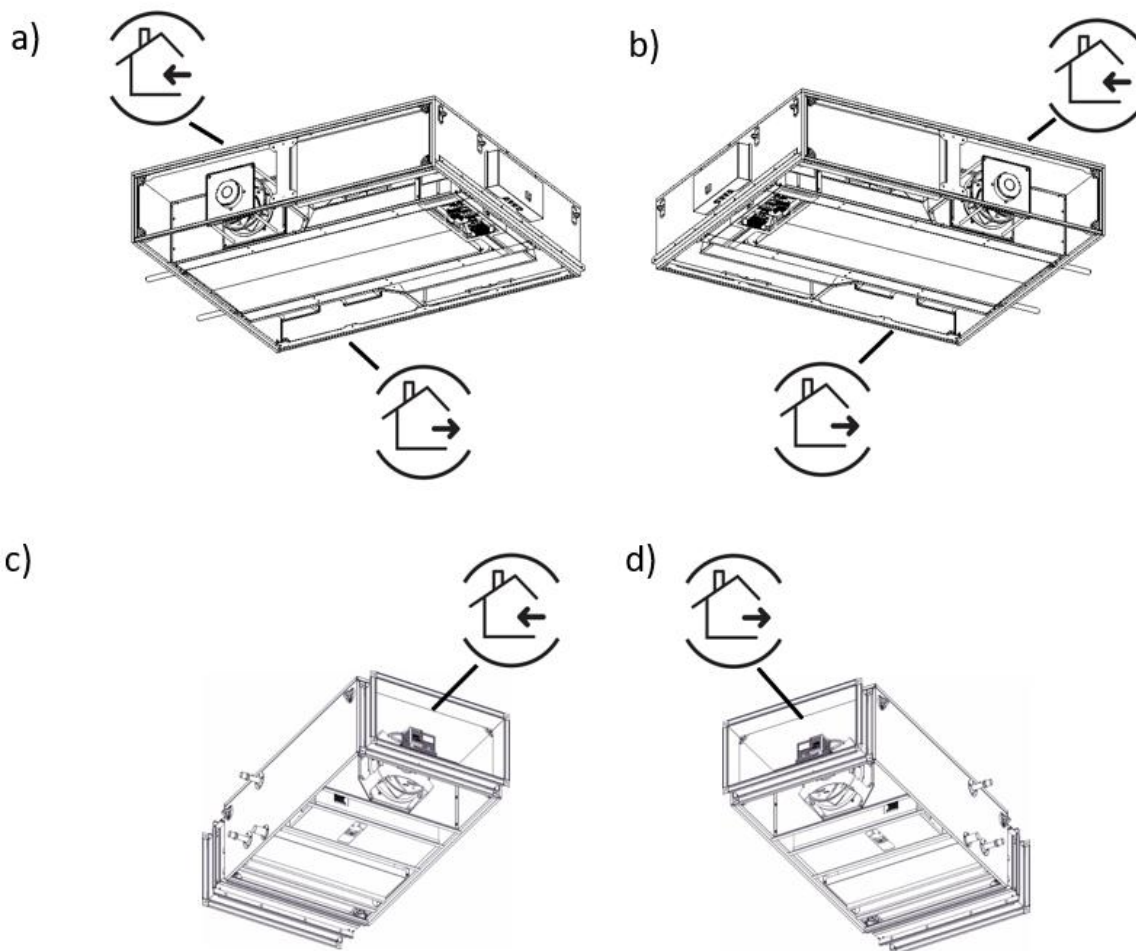

- a) Supply and exhaust air handling unit - right-hand version
- b) Supply and exhaust air handling unit - left-hand design
- c) Air handling unit - right-hand version
- d) Air handling unit - left-hand version

2 PRIOR TO INSTALLATION

2.1 TRANSPORTATION AND STORAGE

Air conditioning units are packaged for easy internal transport and storage at the installation site. After delivery, check all components for any damage in transit. Detailed instructions for this are included in the Receiving Checklist table.

Immediately after receiving the shipment with the device, check for transport damage, according to the points of the checklist.

CHECKLIST UPON RECEIPT	
1	Check all individual packages before accepting the shipment. Inspect packages for damage and completeness according to the bill of lading.
2	If any device (package) appears to be damaged, it should be inspected immediately before accepting the entire shipment. You should also make appropriate, damage-related entries on the waybill. Delivery should not be refused.
3	Inspect the equipment immediately after delivery and before storage for hidden damage. Report hidden damage to the carrier within the time limit set for this purpose from the date of delivery. Check with the carrier on its deadline for filing a claim.
4	Do not move the damaged equipment from the location to which it was delivered directly from the delivery. It is the responsibility of the recipient of the delivery to provide adequate evidence that the latent damage has not already occurred after delivery.
5	If the device in question appears to be damaged, stop unpacking it. Preserve all internal packaging, cartons and boxes. If possible, take pictures of the damage.
6	Immediately notify the carrier of the identified damage: by phone and email in accordance with the procedure. Immediate joint damage control by a joint team of the carrier and consignee of the shipment should be requested.
7	Notify the VTS representative of the damage found and make arrangements for repair. The carrier's representative should inspect the damage before repairing it.
8	Compare the electrical data on the unit's nameplate with the data in the order and shipping documentation to verify that the unit received is the correct one.



! Any damage resulting from improper transportation, unloading or storage is not covered by the warranty, and any claims submitted for cases of the nature described above will not be considered by VTS.

TRANSPORT OF OVERHEAD PANEL SECTIONS

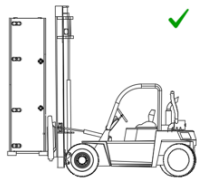

VVS005s-VVS020s
upright
heat recovery section

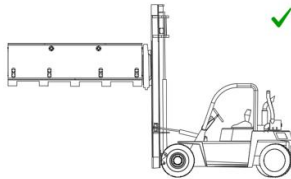

VVS030s
Inverted position
heat recovery section

! Air conditioning units must be transported in the position and manner marked on the original manufacturer's packaging.

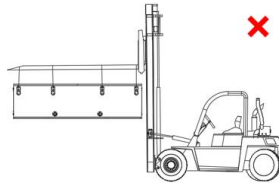
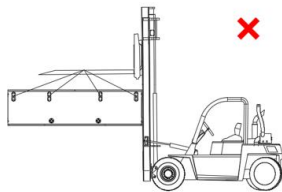

! It is forbidden to lift and transport equipment in a suspended position



! Device packages:

- should be placed in paved, dry areas protected from precipitation,
- should be placed and stored away from areas with active mechanical equipment (vehicles, cranes and other construction machinery),
- should be stored in places where they will not be exposed to any mechanical damage: moisture, aggressive chemicals, liquids, dust and any other external factors, the influence of which may deteriorate their technical and functional condition.

VTS recommends that panels and their equipment be left in their shipping containers on pallets for protection and to facilitate proper setup during installation.

PROHIBITED POSITIONS OF STANDING AND STORAGE OF THE DEVICE

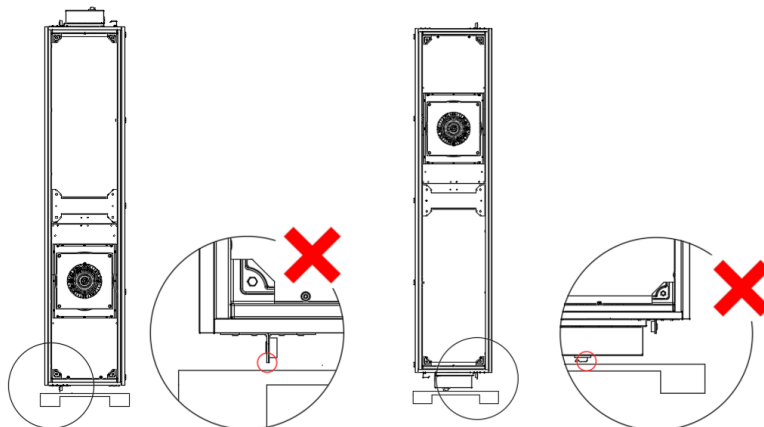

! It is forbidden to stand, rest the equipment on the brackets or the CONTROL junction box.



- ! Devices as well as their components should be:
- stored in rooms with the following conditions:
 - relative humidity: $\varphi < 80 \%$, at $t = (+20) \text{ }^\circ\text{C}$,
 - ambient temperature: $(-40) \text{ }^\circ\text{C} < t < (+60) \text{ }^\circ\text{C}$.
 - protected from contact with corrosive (caustic) dusts, gases or vapors, as well as with any other chemical substances that may have a corrosive effect on the equipment or its accessories

2.2 PREPARATION FOR INSTALLATION

VENTUS VVSs005s-VVS030s units are designed for suspended installation. Suspension of the units requires lifting equipment at the installation site. Make sure that once the unit is installed, there will be enough space to properly bring the technological and electrical installations to the unit and to perform maintenance on the unit without problems

The air handling unit is suspended by default in the horizontal position, but it is also possible to wall-mount it in the vertical position (vertical airflow), provided that the mounting method is approved in advance by VTS and the air handling unit does not contain at least one of the following functions: heat (cool) recovery function, air cooler, electric heater, bag (pocket) filters.



- ! It is not permissible to install VVS air conditioning units in a horizontal position (i.e., with the sides parallel to the ceiling).
- ! It is not permissible to install VVS air conditioning units in a vertical position.

2.2.1 LOCATION OF THE DEVICE

Allow adequate space for the placement of piping and electrical connections. All piping and ductwork should be fixed independently of the air handling unit to reduce excessive noise and vibration.

RECOMMENDATIONS FOR LOCATING THE DEVICE	
1	The weight of the device should be taken into account. When doing so, refer to the weight of the device on its nameplate. The weight on the nameplate does not take into account the weight of the media, which should be taken into account when installing the device.
2	Sufficient space should be left to allow for the removal of enclosure panels and for access to perform maintenance work
3	Installer must provide a lifting device to raise ceiling-mounted air handling units
4	All units must be installed horizontally - only recovery sections with a counter-current heat exchanger must be installed with a slope of 0.5%, towards the condensate drain pipe.
5	Consider the requirements for coil and drain piping.

2.2.2 INSTALLATION OF A DUCTED OVERHEAD PANEL



! Suspension of the air handling unit is carried out by means of hanger brackets, located on both sides of the individual sections of the unit. To suspend the unit, use steel threaded rods with a **minimum diameter of 8mm**. Threaded rods are not included in the manufacturer's supply.

TYPES OF HANGER BRACKETS

Type A

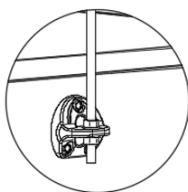

Type B

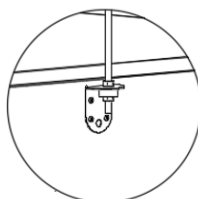

Type C

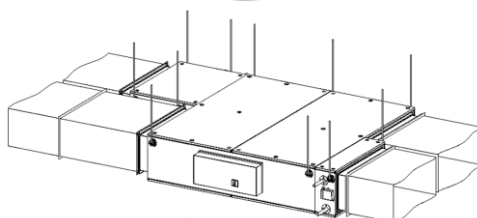
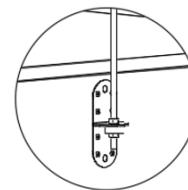

POSITION OF HANGING BRACKETS - HEAT RECOVERY SECTION

A - VVS005s

B - VVS010s

C - VVS015s

D - VVS020s

E - VVS030s

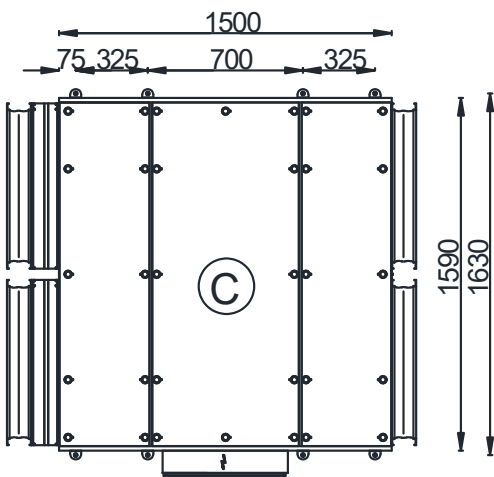
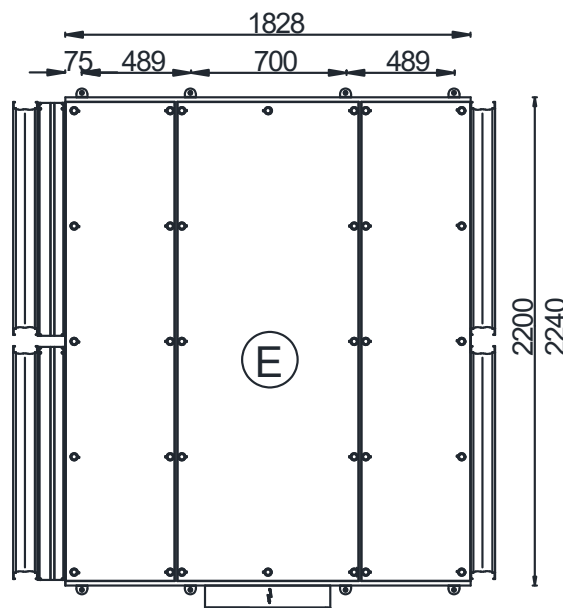
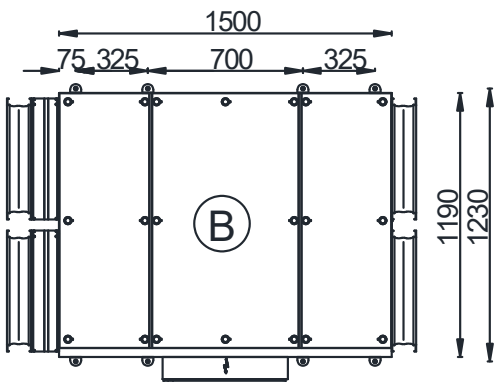
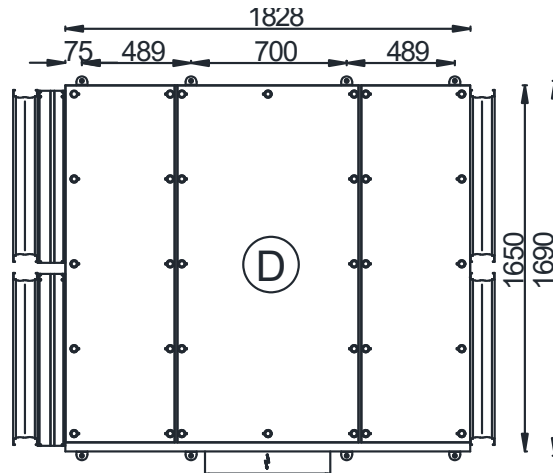
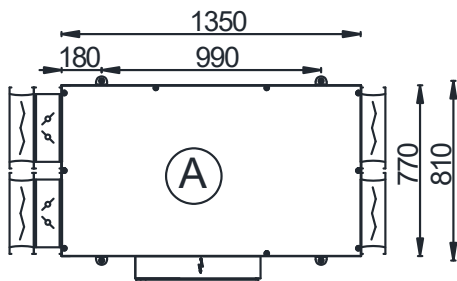

Before installing the units, prepare the air handling unit blocks in the operating position (hanger brackets at the top of the block). Exchanger blocks (countercurrent) hexagonal heat recovery are supplied in the vertical position VVS005s-VVS020s and in the horizontal position inverted by 180° VVS030s.

HOW TO HANDLE THE BLOCK OF THE SUSPENDED SECTION

Reversing the block

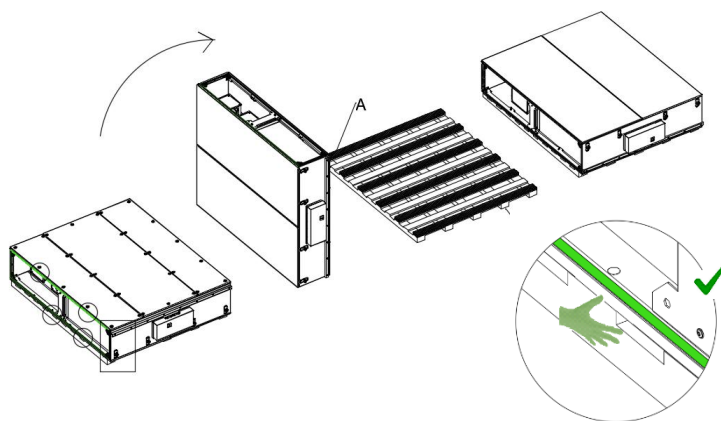

- ! Turn the block over carefully according to the method shown next
- ! Rotate through the side where there are no handles or CONTROL
- ! Grasp the block from underneath or by the frame designed to connect the channels.
- ! Do not leave an unsecured block in an upright position.

NOTE!

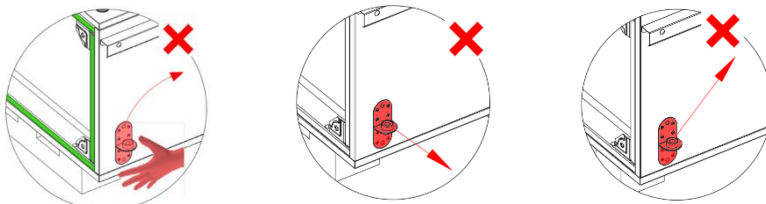

- ! It is forbidden to use handles to lift, pull or rotate the block

INSTALLATION OF EQUIPMENT - CHECKING THE CONDITION OF THE EQUIPMENT

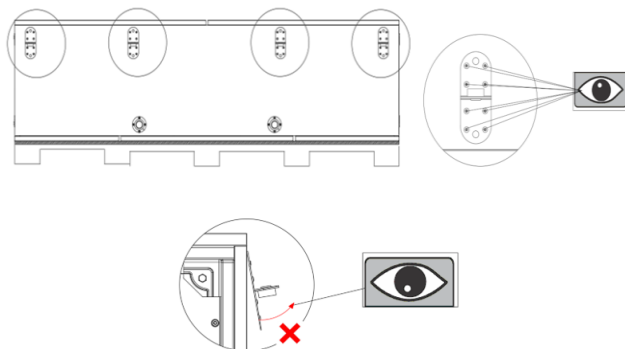

! Before installation, check the condition of the device, in particular, check all hanger brackets. Check for damage, deformation or loosening due to improper transportation or storage.

! If even one of the cases described above has occurred:

**! DO NOT INSTALL THE DEVICE !
! CONTACT
AUTHORIZED MANUFACTURER'S
SERVICE!**

INSTALLATION OF EQUIPMENT - ATTENTION!

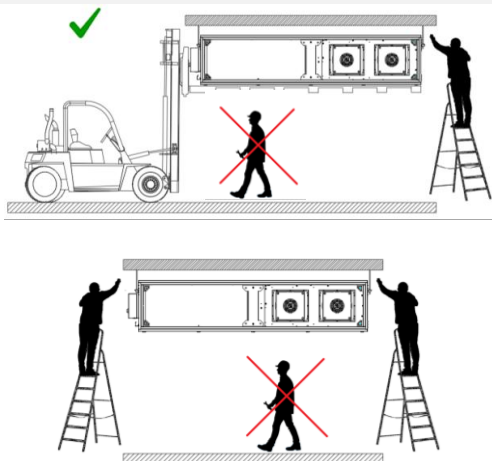

! **SECURE THE INSTALLATION SITE UNTIL COMPLETION.**

! **NO PERSONS ARE ALLOWED UNDER THE MOUNTED DEVICE.**

INSTALLATION OF EQUIPMENT - RULES

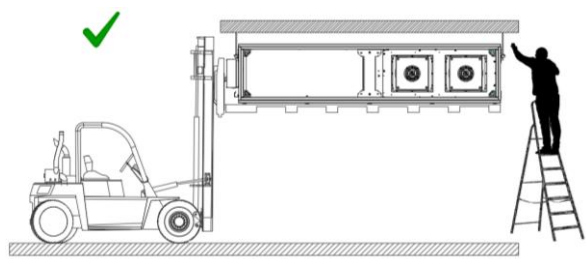

- ! Using lifting equipment, lift the device section to the mounting location. The device section should remain on the lifting equipment until it is completely suspended from the threaded rods.

INSTALLATION OF EQUIPMENT - PRINCIPLES cont.

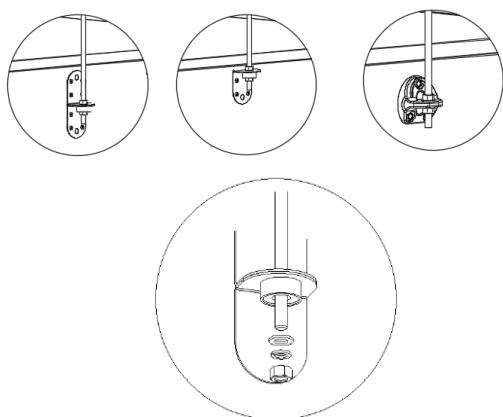
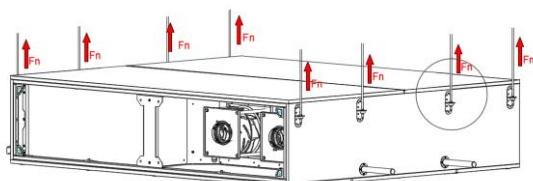

- ! Attach the device to a fixed supporting element (e.g.: ceiling) using threaded rods and screw connections.
- ! Fasten the screw connections on the rods alternately.
- ! Remember to load the rods evenly
- ! Level the control panel

INSTALLATION OF EQUIPMENT - PRINCIPLES cont.



! Remember: the threaded rods must be in the vertical position.

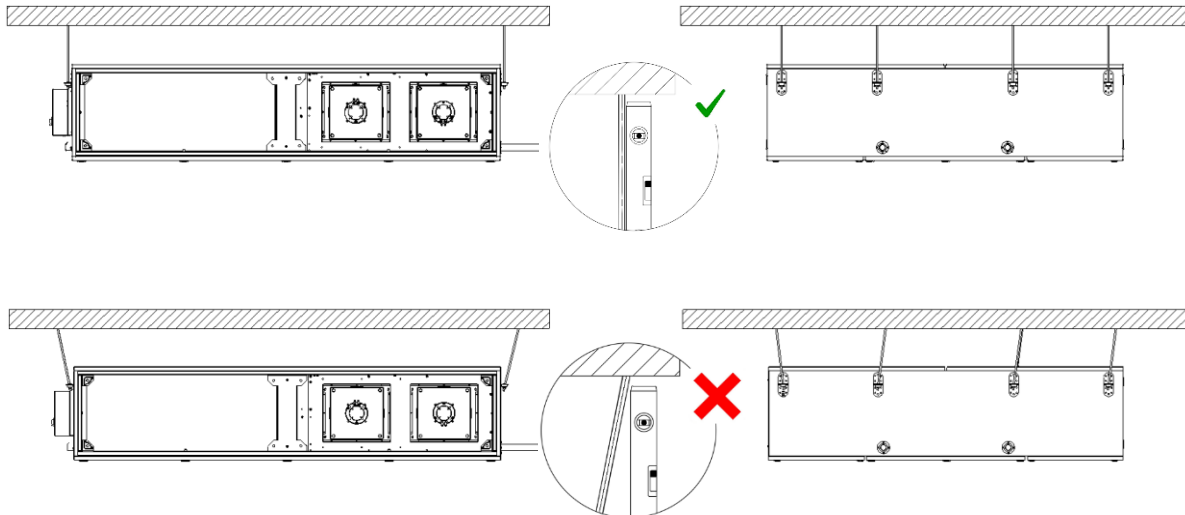

INSTALLATION OF EQUIPMENT - INSTALLATION OF A HEAT RECOVERY UNIT.

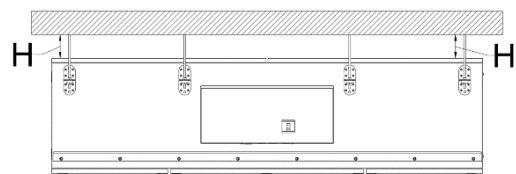

! Heat recovery block must be inclined in the direction of condensate runoff (0.5%)

AHU	005s	010s	015s	020s	030s
b [mm]	4	6	8	8	11

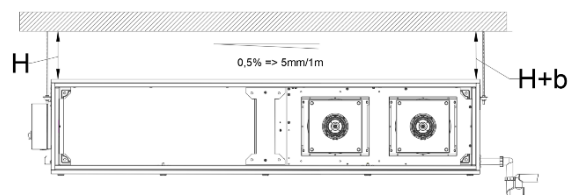
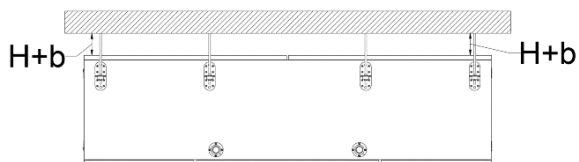

CONDENSATE DRAINAGE

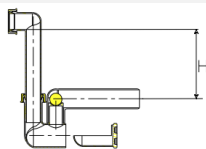

! **H [mm]** = total fan discharge in mm water column ($\text{Pa} \cdot 0.1$)

CONNECTING SECTIONS AND INSTALLING OPTIONAL ELEMENTS

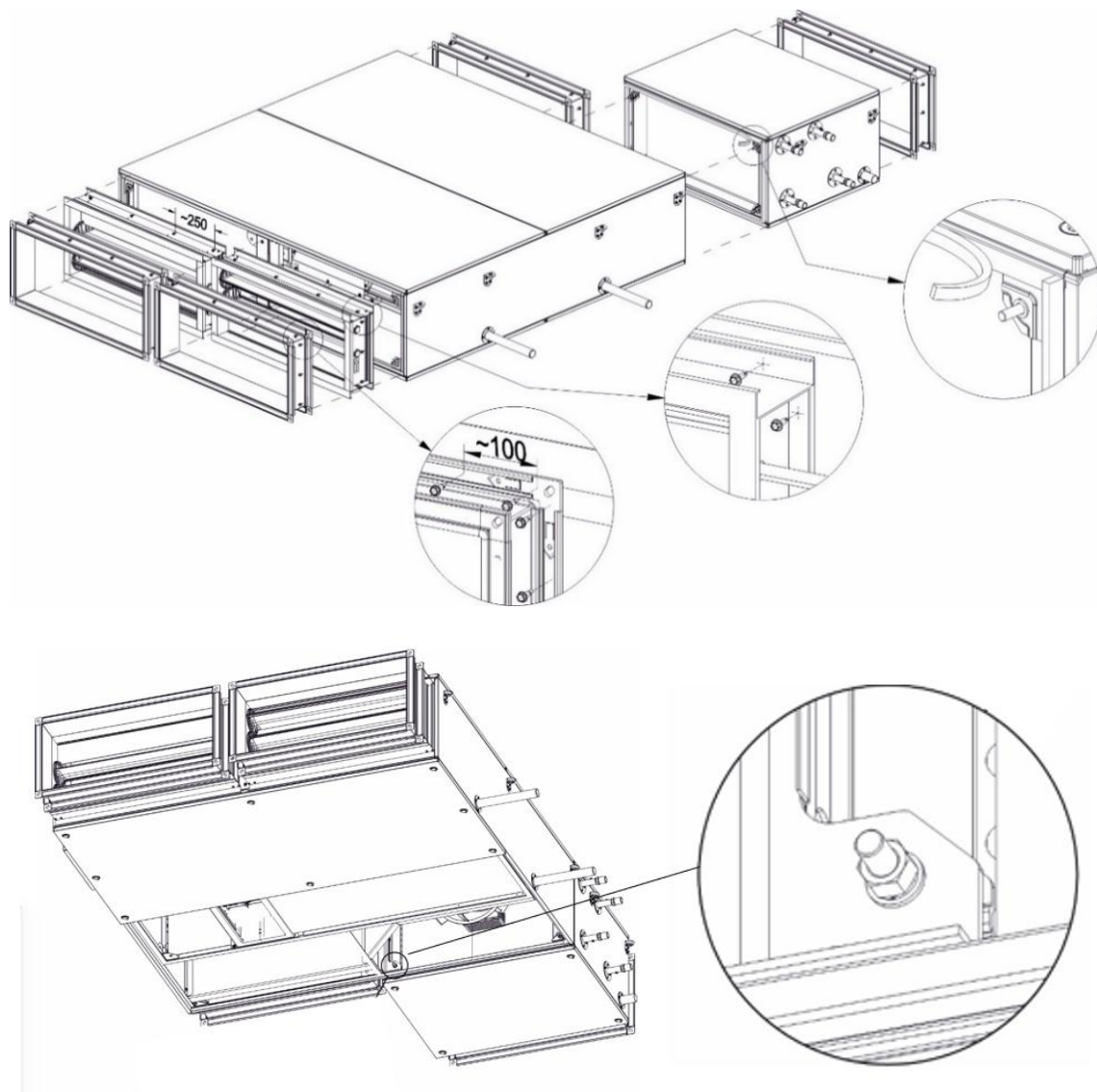

COMBINING CHANNEL FUNCTIONS (WITHOUT INSULATION) TO THE BASE SECTION

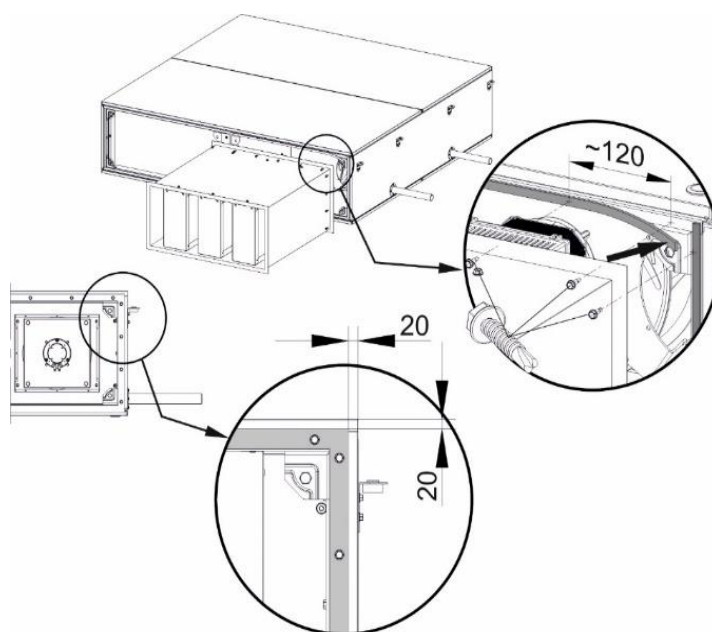

INSTALLATION OF OPPOSITE SILENCERS

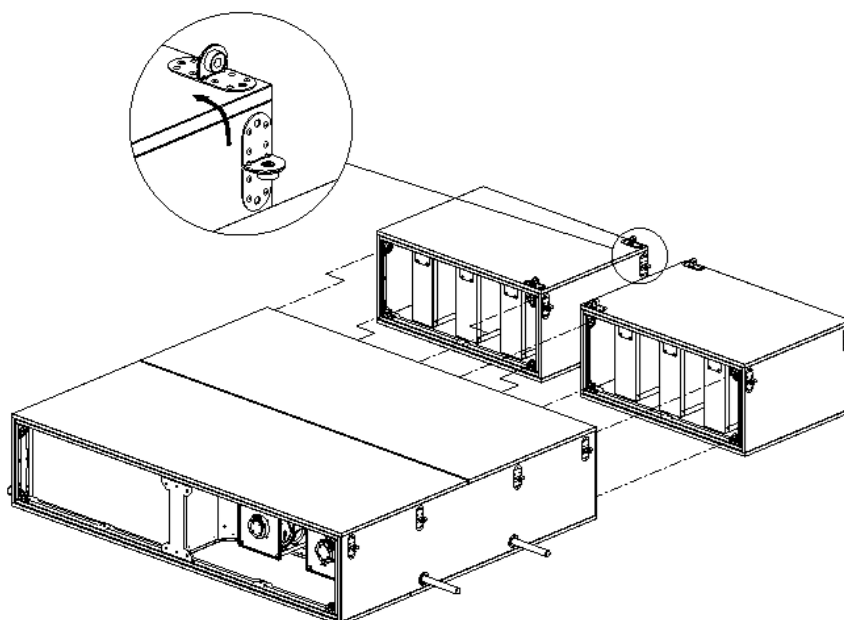

2.2.3 CONNECTING AIR DUCTS

INSTALLATION OF AIR DUCTS

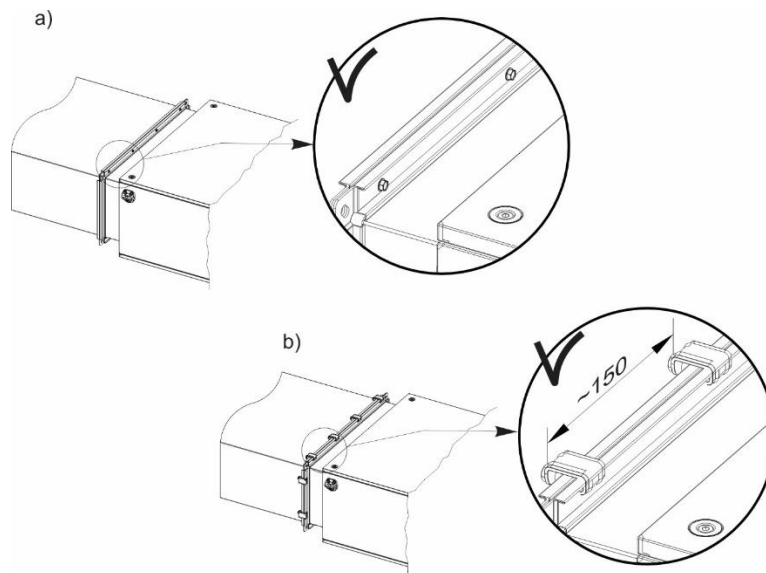

Air ducts should be connected to the air handling unit with flexible connections (optional equipment) that dampen the vibration of the unit and compensate for the misalignment of the duct outputs and the air handling unit.

Flexible connections are equipped with flanges with sealing. Flexible flanges should be connected to channels with self-tapping screws (a) or additional clamping elements (b)

The components used to connect the channels are not included in the standard delivery

3 CONNECTION OF HEAT EXCHANGERS

3.1 CONNECTION OF WATER EXCHANGERS



- ! The operation of the exchanger requires its connection to the system of process heat or chilled water, depending on the designed function of this exchanger.
- ! Exchangers must be protected from freezing (if there is such a risk).
- ! Connection of heat exchangers should be carried out in a manner that does not cause stresses that may result in mechanical damage or leaks. The weight of the pipes and thermal stresses must not be transferred to the exchanger connections.
- ! Power cables should be routed in such a way as to avoid collision with other sections of the air handling unit and other installations.
- ! It must be possible to easily disconnect the exchangers from the process heat or cooling system for maintenance and service operations.
- ! Use compensation at the inlet and outlet of joints, to compensate for linear expansion of pipes.
- ! Hydraulic lines must not be routed over electrical lines.



QUALITY REQUIREMENTS FOR THE SUPPLY MEDIUM WATER EXCHANGERS

- ! Oil and grease < 1 mg/l ! pH at (+25)°C 8-9.
- ! Oxygen < 0.1 mg/L (as low as possible).
- ! Minimum cooler temperature (+3) °C.
- ! Maximum operating temperature (+130)°C.
- ! Maximum working pressure of 16 bar (test pressure of 21bar).
- ! At negative return temperatures, the factor should use an additive that lowers the freezing point, such as glycol (up to a maximum of 50% content in the mixture).
- ! Water hardness not greater than:
 - normal concentration = 4.101 [mval/l] [mval/dm³]
 - molar concentration = 2.051 [mmol/l] [mmol/dm³].
 - Ca⁺²/l = 82.189 [mg Ca⁺²/l] [mg Ca⁺²/dm³].
 - CaCO₃ = 205.25 [mg CaCO₃/l] [mg CaCO₃/dm³] (ppm)
 - French degrees = 20.525 [°f] [°TH].
 - English degrees = 14,400 [°e] [grain CaCO₃/gal(UK)].
 - US = 11,990 [grain CaCO₃/gal(US)].
 - CaO = 115,000 [mg CaO/l] [mg CaO/dm³].
 - German degrees = 11,500 [°n] [°dH].

PROTECTION OF SCREWED CONNECTIONS OF THE WATER EXCHANGER

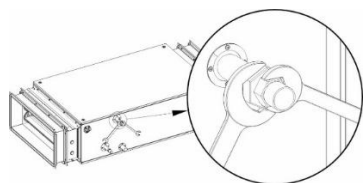

! When installing a supply system for exchangers equipped with bolted connections, the exchanger connector should be relieved with an additional wrench.

PRINCIPLE OF SUPPLYING WATER EXCHANGERS

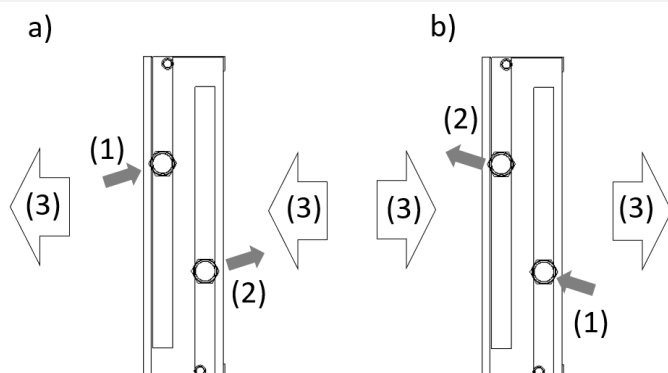

- a) Left-hand execution
- b) Right-hand execution
- (1) Supply of the exchanger with heating/cooling medium
- (2) Return from the factor exchanger
- (3) Direction of air flow in the air handling unit

! Connections of supply and return of the medium from the exchanger should be configured so that the exchanger operates in countercurrent mode. The co-current mode of operation of the exchanger provides a lower average temperature difference, affecting its operating efficiency.

3.2 CONNECTION OF DX (DIRECT EXPANSION COILS) EXCHANGERS



- ! DX exchanger designed to operate with R410A or R32 refrigerant (not supplied) in a system with an expansion valve.
- ! To ensure proper operation of DX coolers or heaters, these exchangers should be connected to the DX system with a condensing unit in accordance with all applicable regulations, rules and best practices.
- ! Maximum working pressure of 38 bar.
- ! Operating or stopping at sub-zero temperatures requires a protection system and a defrosting system. Protect the coil from frost buildup on its surface
- ! The swagger must not be allowed to freeze or frost over completely.
- ! For units equipped with a Freon installation - before installing the unit, check the applicable regulations related to the obligations of the installer, owner (operator) of the heat pump or DX installation (see the F-Gas Law).
- ! Do not release refrigerant into the atmosphere! If the addition or extraction of refrigerant is required, then the service technician performing this operation must follow all local regulations.
- ! The owner of the heat pump or the owner (operator) of the DX installation is required to establish a Product Card, in which all inspections, repairs or modifications to the device are recorded.



PRINCIPLE OF FEEDING DX EXCHANGERS (COOLERS, HEATERS)

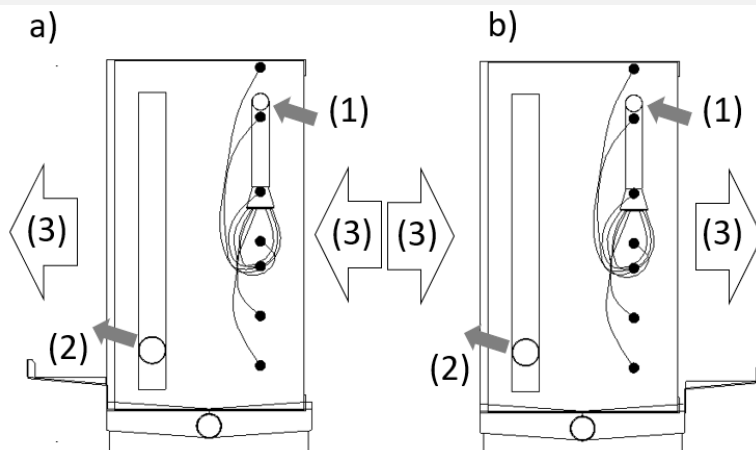

- a) Left-hand execution
- b) Right-hand execution
- (1) Supply of the exchanger (liquid line - supply of the medium to the manifold)
- (2) Suction line (vapor line - return of the refrigerant to the compressor)
- (3) Direction of air flow in the air handling unit

- ! DX heat exchangers have capillary connections. When brazing or welding pipes, avoid exposing pipe components to high temperatures when making capillary connections and protect the valve closest to the connection to be made with a wet cloth.

3.3 CONDENSATE DRAINAGE

Moisture can condense on the surfaces of the air coolers and heat recovery exchanger from the air. The condensed moisture (condensate) flows into the drip tray located below these functions. The installer is required to connect the drip trays to the drainage system, taking into account the use of traps. The condensate drainage is led outside the air handling unit housing. The drains are located in the condensate trays of the coolers and the counter-current heat exchanger (the diameter of the drain pipe is 32 mm).



- ! For proper operation of the air handling unit, it is required to install siphons for baths located on the suction side of the fan (on negative pressure).
- ! It is recommended to use siphons for tubs located on the discharge side of the fan (on positive pressure).
- ! Ball valves cannot be used on the discharge side of the fan.
- ! It is not possible to combine different condensate drains into one trap.
- ! Before starting the air conditioning unit, fill the siphon with water.
- ! If the environment is cold, insulate the drainage lines.
- ! If the condensate is in danger of freezing, use a suitable system for heating it.

CONDENSATE DRAINAGE - SIPHON CONNECTION

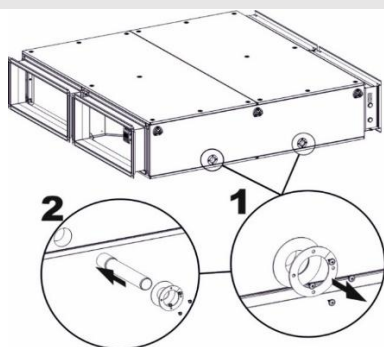

$p < p$ atmospheric

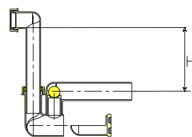

$p > p$ atmospheric

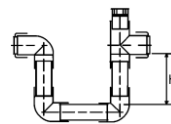

H [mm] = total fan backflow in mm H₂O

H [mm] = Dp [Pa] * 0.1

Dp [Pa] - ventilator airflow in pascals

4 CONNECTION OF ELECTRICAL POWER TO THE CONTROL PANEL

4.1 PLUG&PLAY VERSION CONNECTION

Supply and exhaust units with counter-current hexagonal heat recovery exchanger are pre-wired at the factory and are equipped with advanced control and safety CONTROL. The junction box for the unit's electrical power supply and connection of peripheral CONTROL components is located on the side panel of the air handling unit housing.

JUNCTION BOX (CONTROL SWITCHBOARD) FOR THE CONTROL PANEL

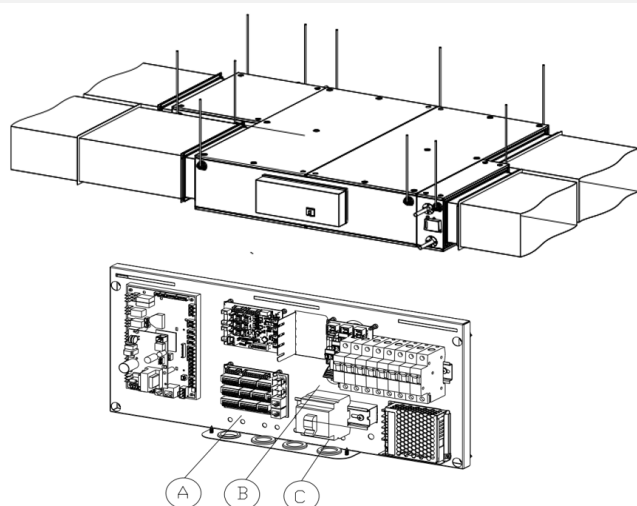

A - Terminal 1 (T1) - place for connecting peripheral CONTROL elements (signal of water valve actuators, channel sensors, etc.)

B - connection of the water pump of the main heater,

C - power supply connections of the control panel and the main switch

The VVS005s control panel uses fuses instead of overcurrent circuit breakers.



- ! Cross-sections and types of cables (e.g., shielded cable), supplying power to individual functional components, should be selected based on rated current and peculiar operating conditions (e.g., ambient temperature, wiring method, distance from power source).
- ! Electric heaters and water pumps for the primary and secondary heaters are to be supplied from an external switchboard (outside the supply)

CONTROL PANEL POWER SUPPLY CONNECTION 1~230V AC

Size headquarters	Number of fans	Rated current single-phases	Security	Power cord
[-]	[-]	[A]	[-]	[-]
VVS005s	x1	9 A	C10/1	3x 1.5mm ²
VVS005s with HE PTC	x1	12.4 A	C16/1	3x 1,5mm ²
VVS010s	x1	16 A	C20/1	3x 2.5mm ²
VVS015s	x1	16 A	C20/1	3x 2.5mm ²
VVS020s	x2	26 A	C32/1	3x 4.0mm ²
VVS030s	x2	26 A	C32/1	3x 4.0mm ²

Applies to a supply and exhaust unit with a counter-current hexagonal exchanger equipped with factory CONTROL.

4.2 CONNECTING VERSIONS WITHOUT FACTORY WIRING

For air-handling units without factory wiring, the air-handling units require power supply to the fan units through electrical boxes located on the fan plenum.

FAN MOTOR CONNECTION BOX

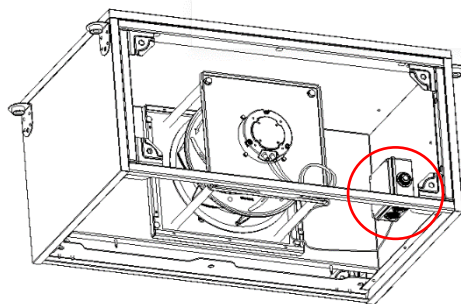

For air handling units without factory wiring, the air handling units require power supply to the fan units through electrical boxes located in the fan plenum.

- ! Cross-sections and types of cables (e.g., shielded cable), supplying power to individual functional components, should be selected based on rated current and peculiar operating conditions (e.g., ambient temperature, wiring method, distance from power source).
- ! EC motors are controlled by ModBus RTU (RS485) signal. If you need to control via 0-10V signal, a 0-10V / ModBus RTU converter is required.

POWER CONNECTION OF FAN SECTIONS - 1~230V AC

Size headquarters	Fan code	Maximum speed (nominal)	Rated current
[-]	[-]	[RPM]	[A]
VVS005s	190 0.18kW 4.00x1	4490	1,20
VVS010s	225 0.38kW 1.64x1	3600	1,56
VVS015s	250 0.38kW 2.00x1	3000	1,74
	250 0.7kW 1.58x1	3800	3,67
VVS020s	225 0.38kW 1.64x2	3800	2 x 3,67
	225 0.74kW 1.33x2	4500	2 x 3,40
	250 0.7kW 1.58x1	3800	3,67
VVS030s	250 0.7kW 1.58x2	3800	2 x 3,67
	250 0.38kW 2.00x2	3000	2 x 1,74

CABLE CONNECTION OF THE AIR HANDLING UNIT FAN MOTOR WITHOUT CONTROL

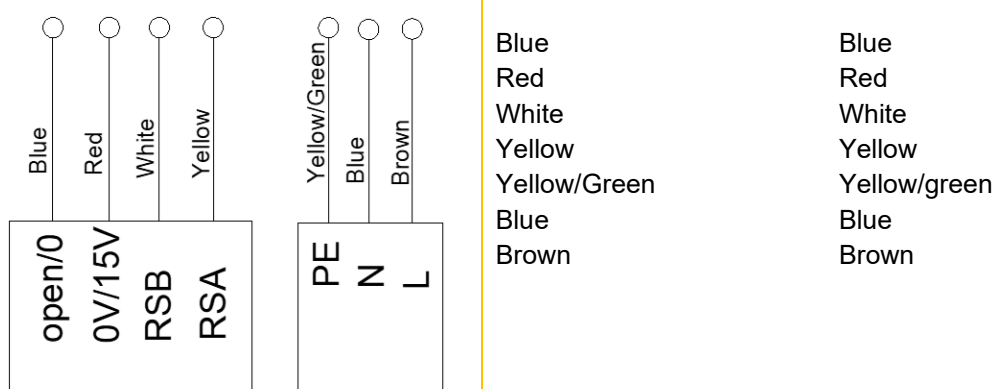

CABLE CONNECTION OF VENTILATOR MOTOR WITH INTERNAL CONNECTION BOX (VVS010s-VVS030s).

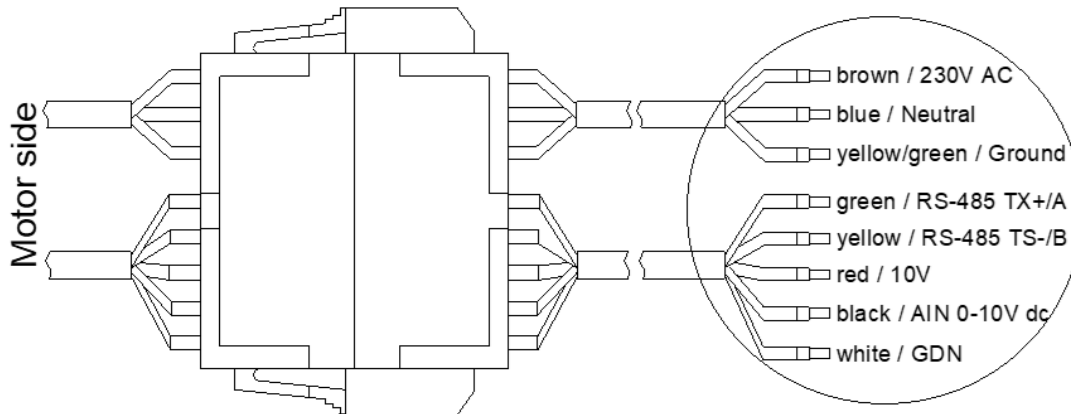

Brown	Brown	230V AC	Yellow	Yellow	RS-485 TX-/B
Blue	Blue	Neutral	Red	Red	DC 10V constant
Yellow/ Green	Yellow/ green	Protective	Black	Black	10V DC input
Green	Green	RS-485 TX+/A	White	Whit	GN

5 ELECTRIC HEATER

5.1 BUILT IN ELECTRIC HEATER (PTC)

The HEX heat exchanger section can be equipped with an optional PTC electric heater, which is factory-wired to the unit's power supply and control system. The heater requires no installation. Dual thermal protection is incorporated, which, when connected in series, will immediately shut down both heaters if one exceeds its temperature. Excessive temperatures (160°C-170°C) will cause the thermal fuse to blow, protecting both the heater and adjacent components in the unit from damage.

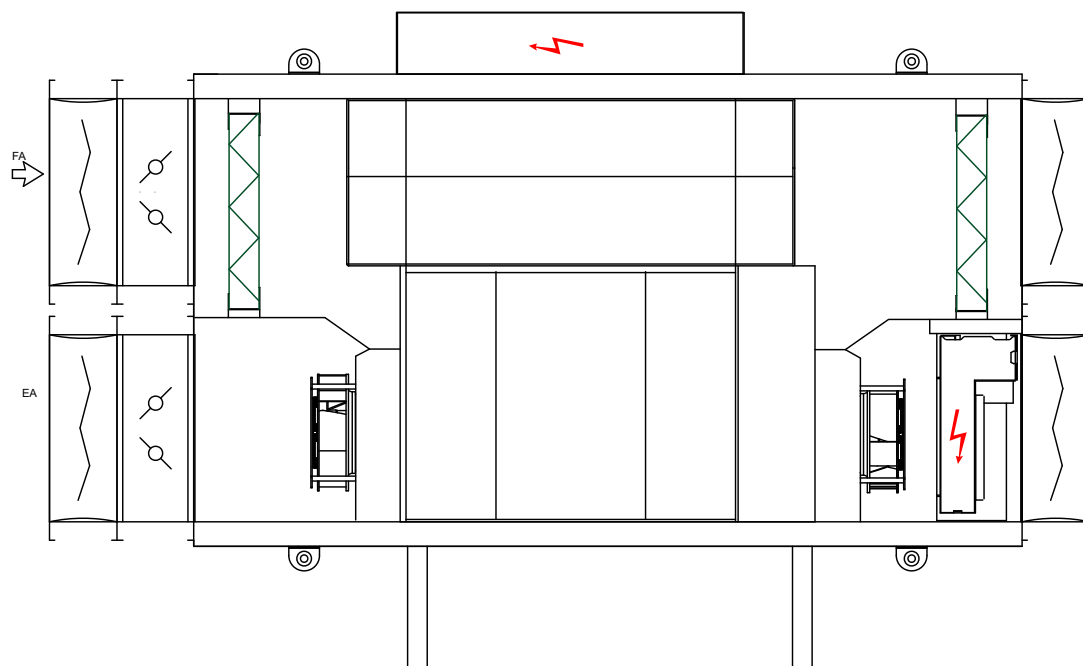

ELECTRIC HEATER CONTROL BOX

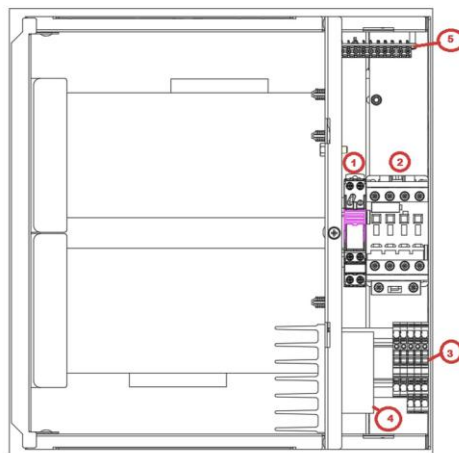
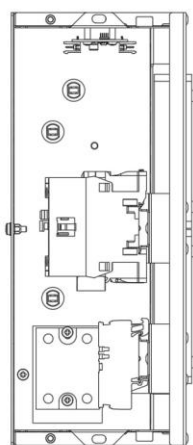

- 1 Relay
- 2 Contactor
- 3 Double and triple terminals
- 4 Solid-state relay
- 5 Controller

5.2 DUCTED ELECTRIC HEATER

5.2.1 GENERAL INFORMATION

The electric heater consists of heating elements (heaters), connection terminal, control CONTROL (SCCR) and protection against excessive temperature rise.

The heaters are Cr-Ni-Fe heating wires of 6kW/400V. They are connected in heating slices (heating sections). The heater can consist of 3 heating slices.

The housing of the heater is galvanized sheet metal without thermal insulation (ventilation duct).

THERMAL INSULATION OF THE ELECTRIC HEATER AT THE FACILITY.

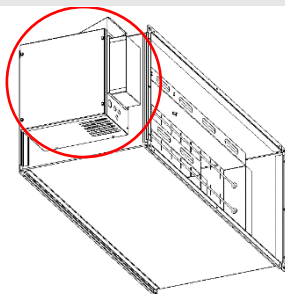

- ! Insulating the ventilation ducts, which include the electric heater, the heater housing), ensure that the connection point (especially its vents) is outside the insulation layer.

CONFIGURATION OF HEATING SLICES (SECTIONS)			
Size of the AHU	Maximum Number of Slices	Power of a single slice	Total power of the heater
[-]	[pcs.]	[kW]	[kW]
VVS005s	1	10	10
VVS010s	1	12	12
VVS015s	2	18	36
VVS020s	2	18	36
VVS030s	2	18	36

Modulating the Supply Voltage Depending on the Heating Power Demand (First Heating Slice).



The first slice is controlled smoothly 0-10V, each other (ON/OFF) ON-OFF.

Each time the regulated slice reaches full power, the demand is transferred to the next slice, which starts operating at full capacity. Any additional heating power will be realized by smoothly increasing the adjustable heating power of the modulating slice.

ELECTRICAL INSTALLATION DETAILS

Type of network	TN
Rated supply voltage	3x400V AC
Rated insulation voltage	400V
Rated withstand surge voltage	2500V
Rated short-circuit current I_{cw} for individual circuits - the effective value of the periodic component withstood for 1s, i.e., the short-circuit current expected at the switching voltage	6kA
Rated short-circuit current	6kA
Simultaneity factor	0,8
Rated frequency	50 Hz
Degree of protection	IP00
Permissible operating temperature	0 °C ÷ (+50) °C
Supply voltage of control circuits	24V DC
Type of network	TN
Rated supply voltage	3~ 400V AC
Rated insulation voltage	400V
Rated withstand surge voltage	2500V

5.2.2 HEATER POWER SUPPLY CONNECTION AND CURRENT PROTECTION

- !** The power connection must be made using a separate switchboard, which is not supplied with the VTS delivery.
- !** The connection of the heater should be made in such a way that it is not possible for the heater to switch on when the fan is not on - for this purpose there are factory-mounted, serially connected protections in the form of a thermostat and pressure switch, preventing the heater from switching on if the temperature and airflow conditions are not met.
- !** If the fan is stopped, it is absolutely necessary to turn off the power supply to the heater.

AVAILABLE POWER VARIANTS OF ELECTRIC HEATERS (3~400V AC 50HZ)						
Type	Size of the AHU	Power	Switchgear type	Power cord		
				L1/L2/L3 nominal current [A].	Security [A]	Cable cross section [mm ²]
[-]	[-]	[kW]	[kW]	[A]	[A]	[mm ²]
Low power	VVS005s	2,5	1x18	6,3/6,3/0	10	1,5
	VVS005s	2,5	1x18	6,3/6,3/0	10	1,5
	VVS010s	3	1x18	7,5/7,5/0	10	1,5
	VVS015s	6	1x18	8,7/8,7/8,7	16	2,5
	VVS020s	6	1x18	8,7/8,7/8,7	16	2,5
	VVS030s	6	1x18	8,7/8,7/8,7	16	2,5
High power	VVS005s	10	1x18	21,6/12,5/12,5	25	4
	VVS010s	12	1x18	26/15/15	32	6
	VVS015s	18	1x18	26/26/26	32	6
	VVS015s	36	2x18	52/52/52	63	16
	VVS020s	18	1x18	26/26/26	32	6
	VVS020s	36	2x18	52/52/52	63	16
	VVS030s	18	1x18	26/26/26	32	6
	VVS030s	36	2x18	52/52/52	63	16

! The heater section is labeled "Switchgear type". Take this into account when identifying the power and type of electric heater.

The type of conductors used for each heater function is shown in the table below. The conductor cross-section and its protection should be selected based on the information indicated in the table above.

Types of wires to connect electric heaters			
Application of the cable	Rated voltage	Type	Operating temperature
Power supply for electric heaters	3~400V AC	multicore, copper conductor - stranded wire	(-30) C° ÷ (+60) C°
Power supply for the control system	1~230V AC	multicore, copper conductor - stranded wire	(-30) C° ÷ (+60) C°
Control of the heater CONTROL system	24V DC	multicore, copper conductor - stranded wire	(-30) C° ÷ (+60) C°

CONNECTION OF ELECTRIC HEATER WITH SWITCHGEAR 1X18KW

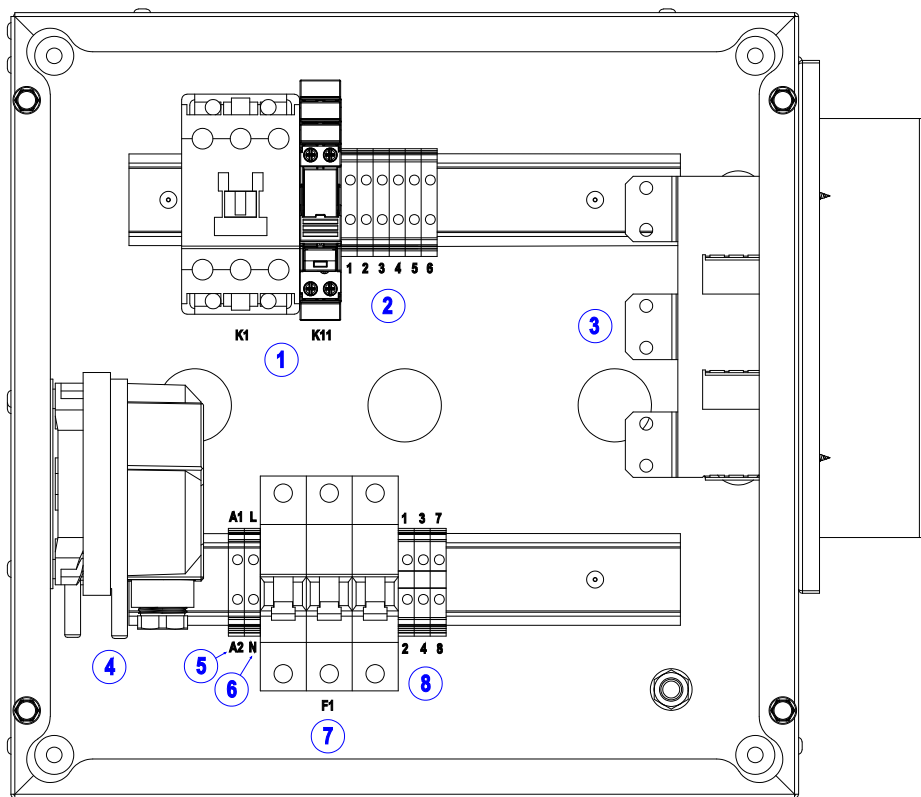

Designation	Description	Connecting	Comments
1	relays / contactors	factory	-
2	heater terminals	factory	-
3	heaters	factory	-
4	pressure switch	factory / <u>installer</u>	<u>the connection of the pressure switch tubes is made by the user</u>
5	signal terminals - alarm	<u>on site / installer</u>	-
6	power terminals 1f	<u>on site / installer</u>	-
7	overcurrent circuit breakers	<u>on site / installer</u>	-
8	signal terminals - control	<u>on site / installer</u>	-

The shown views of switchgear are intended to illustrate the arrangement of components inside their housing. Please note that they are for illustrative purposes only - when making electrical connections, always follow the electrical diagrams

CONNECTION OF ELECTRIC HEATER WITH 2X18KW SWITCHGEAR

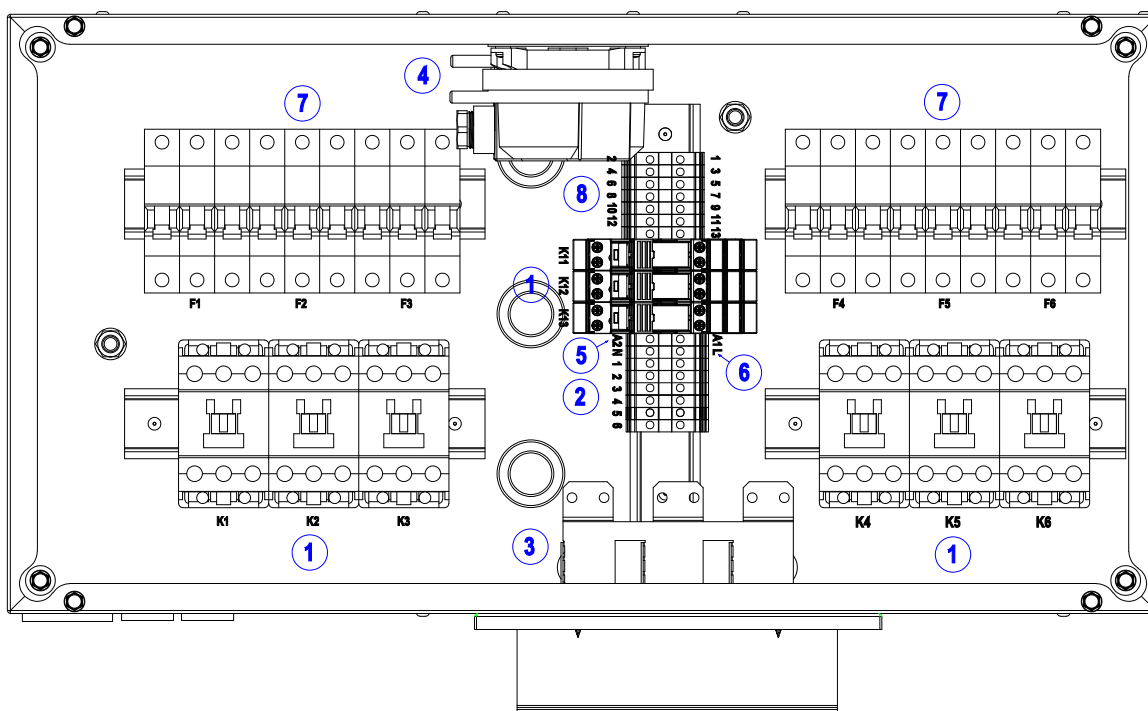

Designation	Description	Connecting	Comments
1	relays / contactors	factory	-
2	heater terminals	factory	-
3	heaters	factory	-
4	pressure switch	factory / <u>installer</u>	<u>the connection of the pressure switch tubes is made by the user</u>
5	signal terminals - alarm	<u>on site / installer</u>	-
6	power terminals 1f	<u>on site / installer</u>	-
7	overcurrent circuit breakers	<u>on site / installer</u>	-
8	signal terminals - control	<u>on site / installer</u>	-

The shown views of switchgear are intended to illustrate the arrangement of components inside their housing. Please note that they are for illustrative purposes only - when making electrical connections, always follow the electrical diagrams

5.2.3 THERMAL SWITCH (THERMIC)

The functionality of the thermostat is based on the properties of the bimetallic element - it causes the contacts of the heater control circuit to open when the air temperature near the thermostat is 65°C. After an emergency shutdown, the heater automatically turns on when the air temperature drops by 20°C. After intentional or emergency (caused by overheating) power off, the supply fan must run for a certain period of time (0.5-5 min), so that the heater heaters reach normal temperature.



! The thermal switch is an integrated, factory-installed component of each heater patch - it requires no additional installation or electrical connection by the installer.

THERMAL SWITCH- CHARACTERISTICS

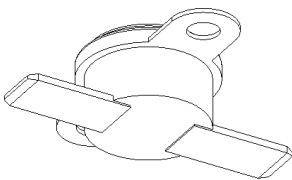
Thermal switch	Connecting	Comments
	Function	heater protection against overheating (temperature control of heating elements)
	Construction	<ul style="list-style-type: none"> • metal casing • two screw terminals • bimetallic element with NC contact function
	Rated operating voltage	30V DC
	Output signal type	Voltage-free (switching contact)
	Activation temperature	(+65) °C
	Temperature hysteresis	17 °C

5.2.4 DIFFERENTIAL PRESSURE SWITCH

The differential pressure switch is another safety element, in addition to the thermostat, that prevents the heater from operating in prohibited conditions. It prevents the heater from switching on when the pressure generated by the fan units on the supply side of the air handling unit is insufficient to ensure safe operation of the heating elements.



! The pressure switch is a factory-installed component and electrically connected - **the connection of pressure switch pressure hoses should be made at the site according to the following recommendations:**

- one of the wires should be led to atmospheric pressure - if the switchgear is mounted on a duct (outside), the cable does not need to be connected - the switchgear is at atmospheric pressure,
- The second of the wires should be connected at the positive or negative pressure in the control panel or in the duct (before or after the supply motor),
- it is permissible to move the pressure switch outside the switchboard (in the duct version of the heater) to avoid the need to run long measuring tubes - the recommended position of the pressure switch - horizontal, with a vertical position the reading is overstated by 11Pa compared to the actual one.



! The switching threshold of the pressure switch is 20 Pa. After connecting to the AHU, check, whether the pressure switch operates correctly for the smallest available capacity of the AHU. **If there is no detected differential pressure**, change the place of connection of the second pressure hose to the system.

! In the reverse case - **when for a given pressure switch setting the pressure difference is detected even when the air handling unit is switched off** (permission to operate the heater despite the lack of operation of fans), the setting should be gradually increased until correct operation is achieved - its sign is the lack of operation of the electric heater despite the occurrence of control signals, if the pressure switch does not detect a pressure difference between the measurement channels - permission should be given only after after starting the fans.

! **After the pressure switch is fully connected, the heater shutdown test should be performed.** To do this, force the control of the electric heater manually (e.g., providing control signals of the heater from the controller) and at the same time stop the control of the fans. The pressure switch should prevent the operation of the electric heater (this will be evident, for example, by disconnecting the contactors in the switchboard).

DIFFERENTIAL PRESSURE SWITCH - CHARACTERISTICS

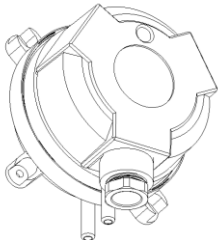
Differential pressure switch	Connecting	Comments
	Function	protecting the heater from overheating (controlling the pressure difference between the supply duct and atmospheric pressure)
	Construction	<ul style="list-style-type: none"> plastic housing, two screw terminals, membrane connected to mechanical module
	Rated operating voltage	30 V DC
	Output signal type	Voltage-free (switching contact)
	Measuring range	20-300 Pa

5.2.5 CONNECTION OF ELECTRIC HEATER CONTROL

MARKING OF THE CONNECTION CABLE OF THE ELECTRIC HEATER - PLUG&PLAY CONTROL

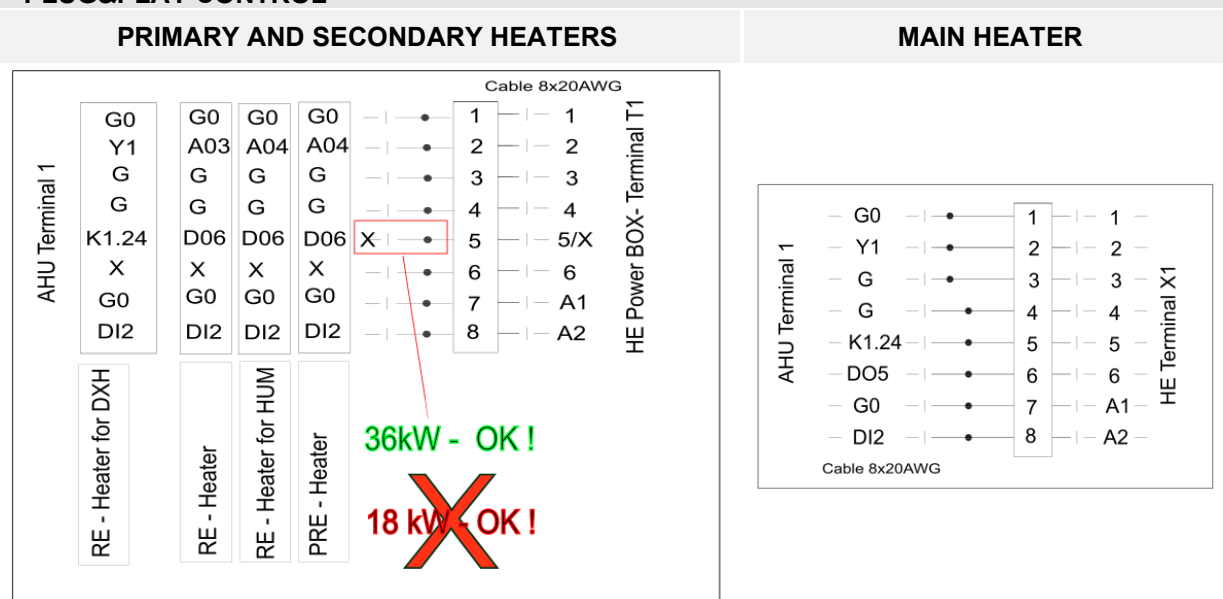

5/x - connect only up to 36kW

AHU Terminal 1 - Connection terminal "Terminal 1" in the panel box/distribution panel.

HE Power BOX - X1 connection terminal in the electric heater box/distribution panel.

RE-Heater - Secondary heater for the case other than the following.

RE-Heater DXH - Secondary heater for heat pump unit (C_dhx).

RE-Heater for HUM - A secondary heater for a humidifier unit.

PRE-Heater - Pre-heater.

K1.24 - the connection should be made to pin 24 of the pump relay (K1) located in the CONTROL switchboard of the AHU

CONNECTION OF CONTROL OF ELECTRIC HEATERS - CONTACTS: 1, 3, 4, L, N, A1, A2							
No. Contact X1	Symbol Style	Connected Signal	Steering wheel type	Controller contact code *			
1	GND	Grounding	⇒ CBX VTS	G0			
			Plug & Play	G0			
			Other than VTS	GND			
3	24V DC	Power supply 24V DC	⇒ CBX VTS	G			
			Plug & Play	G			
			Other than VTS	+24V DC			
4	St1	Grade 1	⇒	Number of Sections			
				1	2	3	
				CBX VTS	G	G	G
				Plug & Play	G	G	G
			Other than VTS	+24V DC	+24V DC	+24V DC	
L	L	Power supply 230V AC	⇒	230V AC			
N	N						
A1	A1	Confirmation of work	⇒ CBX VTS	DI2			
			Plug & Play	DI2			
			Other than VTS	Potential-free contact			
A2	A2	Confirmation of work	⇒ CBX VTS	G0			
			Plug & Play	G0			
			Other than VTS	Potential-free contact			

CONNECTION OF CONTROL OF ELECTRIC HEATERS - CONTACT 2					
Contact No. X1	Contact Code	Connected Signal	Steering wheel type	Heater function	Contact code on the steering wheel*
2	0-10V	Signal 0-10V	⇒ CBX VTS	Main	Y1
				Preliminary	AO2
				Secondary - heat pump unit (C_dxh)	NO1
				Secondary - device with humidifier	NO1
				Secondary - Another case	NO1
			⇒ Plug & Play	Main	Y1
				Preliminary	AO4
				Secondary - heat pump unit (C_dxh)	Y1
				Secondary - device with humidifier	AO4
				Secondary - Another case	AO3
⇒ Other than VTS	All	0-10V DC			

CONNECTION OF CONTROL OF ELECTRIC HEATERS - CONTACT 5

Contact No. X1	Contact Code	Connected Signal	Steering wheel type	Heater function	Contact code on the steering wheel		
					Number of Sections		
					1	2	3
5	St2	Grade 2	⇒ CBX VTS	Main	-	K1.24**	K1.24**
				Preliminary	-	NO3	
				Secondary - heat pump unit (C_dhx)	-	K1.24**	
				Secondary - device with humidifier	-	NO3	
				Secondary - Another case	-	NO3	
			⇒ Plug & Play	Main	-	K1.24**	K1.24**
				Preliminary	-	DO6	
				Secondary - heat pump unit (C_dhx)	-	K1.24**	
				Secondary - device with humidifier	-	DO6	
				Secondary - Another case	-	DO6	
			⇒ Other than VTS	All		+24V DC	+24V DC

** the connection should be made to pin No. 24 of the pump relay (K1) located in the CONTROL switchboard AHU

CONNECTION OF CONTROL OF ELECTRIC HEATERS - CONTACT 6

Contact No. X1	Contact Code	Connected Signal	Steering wheel type	Heater function	Contact code on the steering wheel*
6	St3	Grade 3	⇒ CBX VTS	Main	NO6
				Preliminary	
				Secondary - heat pump unit (C_dhx)	
				Secondary - device with humidifier	
				Secondary - Another case	
			⇒ Plug & Play	Main	DO5
				Preliminary	
				Secondary - heat pump unit (C_dhx)	
				Secondary - device with humidifier	
				Secondary - Another case	
			⇒ Other than VTS	All	+24V DC

6 PLUG&PLAY COMPONENTS

The base unit of *VENTUS COMPACT* suspended air handling units containing the hexagonal heat exchanger, fans and air filters is delivered as a pre-wired unit with the configured control system connected. The control system is based on the factory-programmed and built-in uPC3 controller.

Peripheral CONTROL components, the specifics of which require installation outside the base unit (room or duct mounted sensors, actuators, valves) are supplied in separate packages. It is necessary to connect them on the site in accordance with the installation and connection instructions.

LABELING OF PLUG&PLAY CONTROL COMPONENTS

Control components that require connection at the site are equipped with connection cables that include a label with the method of connection to Terminal 1

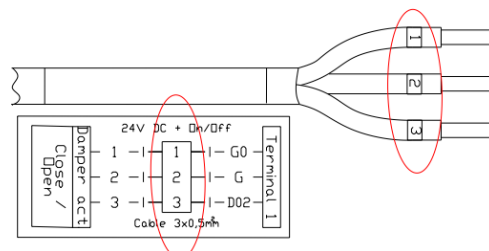

6.1 STANDARD EQUIPMENT WITH FACTORY-MOUNTED CONTROL ELEMENTS

STANDARD CONTROL COMPONENTS - INSTALLATION AND FACTORY CONNECTION		
Designation	Name	Location
	uPC3 controller	Control switchgear
	Terminal 1 (T1)	Connection terminal for peripheral control components
	Security	Control switchgear (according to the diagram)
B2	Temperature sensor	Return air from the (exhaust before recovery)
H2	Moisture sensor	Return air from the (exhaust before recovery)
B4	Temperature sensor	Exhaust air (exhaust after recovery)
B6	Temperature sensor	Supply air (after recovery)
B3	Temperature sensor	Outside air (before recovery)
	Differential pressure sensor	Supply air (pre-filter)
	Differential pressure sensor	Supply air (fan)
	Differential pressure sensor	Exhaust air (pre-filter)
	Differential pressure sensor	Exhaust air (fan)

The sensors are mounted in the heat recovery section.

6.2 CONNECTION TERMINAL 1 (T1)

Terminal 1 (T1) is connected to the upc3 controller at the factory and is a dedicated terminal for connecting peripheral control elements that exist outside the base unit of the device and therefore could not be connected at the factory. Additional control elements outside the VTS product range can also be connected to Terminal 1 (T1). Terminal 1 is located in the controls switchgear.

CONNECTION TERMINAL 1 (T1)

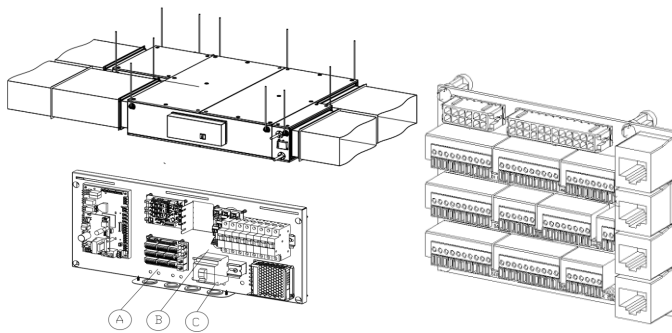

- A** - Terminal 1 (T1) - the place for connecting peripheral control components (signal of water valve actuators, duct sensors, etc.).
- B** - connection of the water pump of the main heater.
- C** - power connection of the control panel and the main switch.

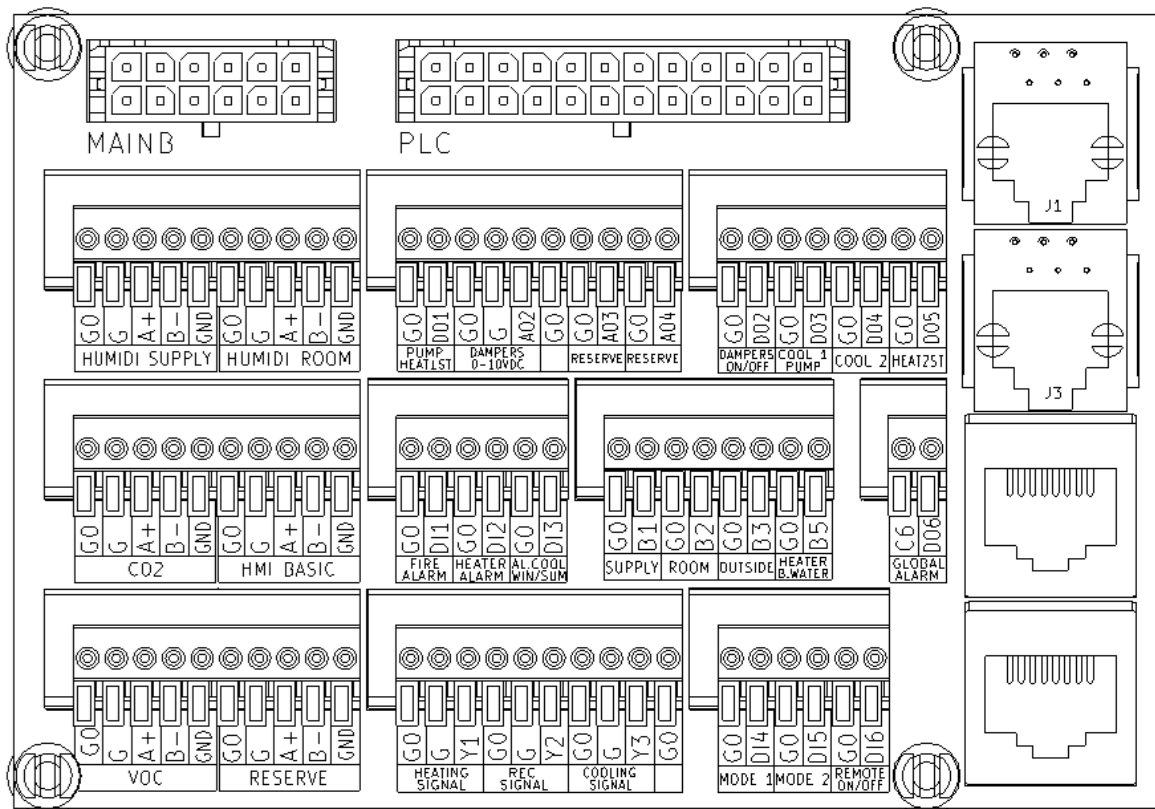

Terminal 1 (T1) has universal function designations. In some configurations, the pin designations may conflict with the connection instructions. In this case, the connection instructions are valid.

6.3 CABLE STANDARDS

APPLICATION	TYPE WIRED	WIRED
Fire alarm relay	[2]	2x0,75
Multifunction switch	[2]	2x0,75
Optional multifunction switch	[2]	2x0,75
Supply air temperature sensor	[1]	2x0,75
Room/exhaust air temperature sensor	[1]	2x0,75
Return water temperature sensor for water heater	[1]	2x0,75
Electric heater (HE) alarm relay	[2]	2x0,75
Air-side antifreeze thermostat to protect the water heater from freezing	[2]	2x0,75
Analog controlled water heater valve	[1]	3x0,75
Electric heater power control input	[1]	3x0,75
Water heater circulating pump contactor		3x1,5
Alarm relay of refrigerator / cooling unit / heating pump	[2]	2x0,75
Refrigerator startup input	[2]	2x0,75
Chiller startup input - stage I	[2]	2x0,75
Chiller startup input - stage II	[2]	2x0,75
Recirculation throttle actuator	[1]	3x0,75
Cross-flow heat exchanger bypass actuator	[1]	3x0,75
HMI Basic UPC control panel - interface with limited functionality	[3]	UTP 1x2
HMI Advanced UPC control panel - full-function interface	[4]	8x0,1

ID	TYPE WIRED	DESCRIPTION
[1]	Cables for transmission of control signals - shielded copper wires. PVC insulation.	Rated voltage 300/500 V. Ambient temperature: from 30 °C to 80 °C.
[2]	Copper conductors PVC insulation	Rated voltage 450/750V. Ambient temperature: from -40 to 70 °C
[3]	Copper conductors PVC insulation	Voltage rating of 150 V. Ambient temperature: - 20...60°C
[4]	Flat unshielded data cables.	Voltage rating of 150 V. Ambient temperature: - 20...60°C

6.4 ANALOG INPUTS (NTC10K)

ANALOG INPUTS (NTC10K)

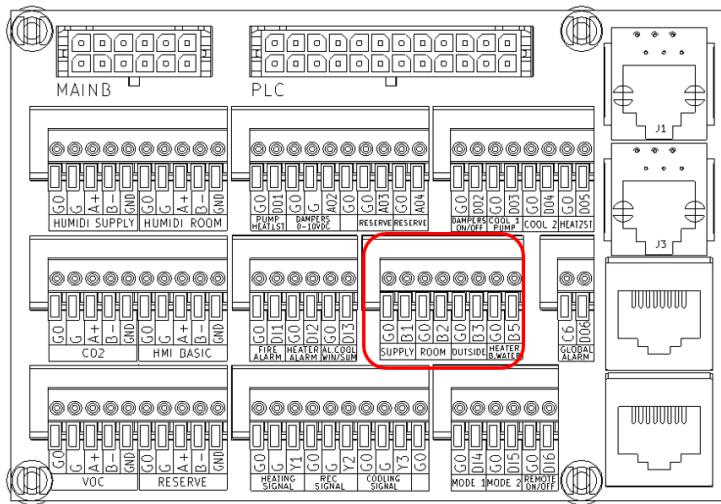

- B1 Duct temperature sensor - supply air
- B2* Temperature sensor - exhaust air
- B2/6 Duct sensor behind the preheater
- B3** Temperature sensor - outside air
- B5*** Touchdown water heater temperature sensor.

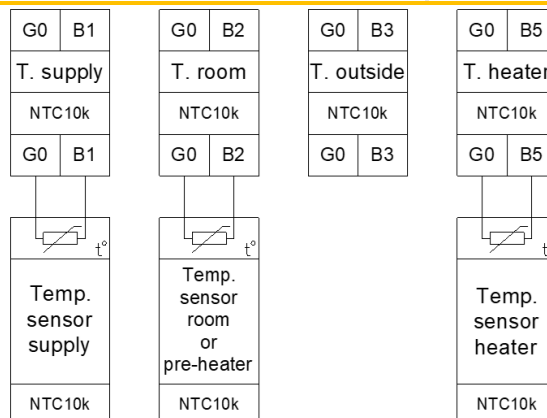

- B2* - Exhaust air temperature sensor that is factory installed at the heat recovery. If a room sensor is used as the lead sensor (other than HMI BASIC), this sensor must be connected to B2 on terminal 1 of T1
- B3** - Factory connections are made outside the T1 terminal directly in the uPC3 controller
- B5*** - Touchscreen water heater temperature sensor which is assigned to only one heater (pre or main). Priority of application is given to the pre-heater.

6.4.1 SUPPLY AIR TEMPERATURE SENSOR B1

SUPPLY AIR TEMPERATURE SENSOR B1

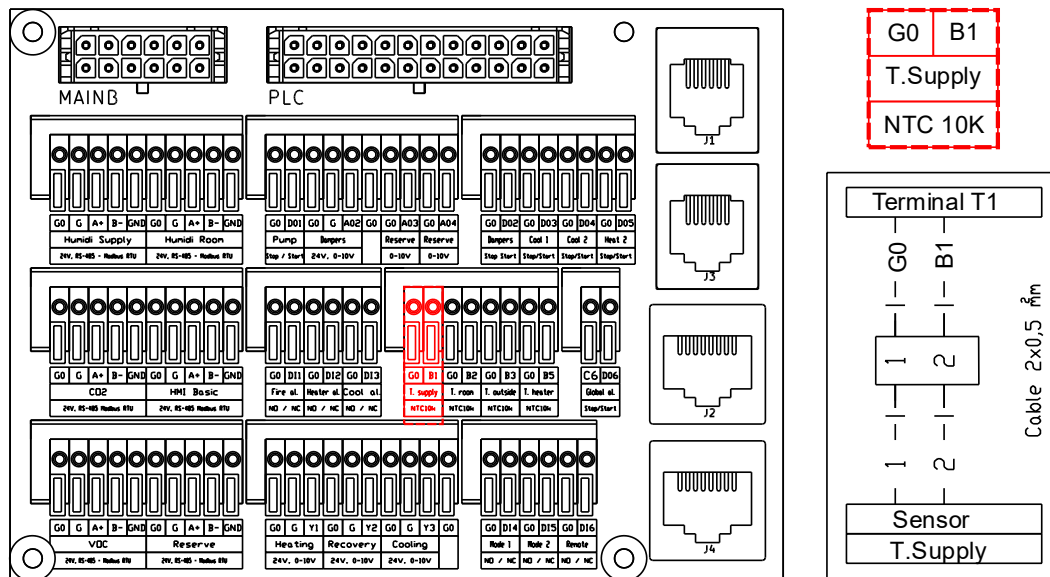

The sensor should be placed in the supply air duct after the last function that changes the air temperature in a stabilized and homogeneous air stream with a uniform temperature distribution.

The minimum distance between the air outlet of the device section and the sensor should be no less than the distance defined as $1.5 \times$ the diagonal of the rectangular connection.

6.4.2 TOUCHSCREEN WATER HEATER TEMPERATURE SENSOR B5

TOUCHSCREEN WATER HEATER TEMPERATURE SENSOR B5

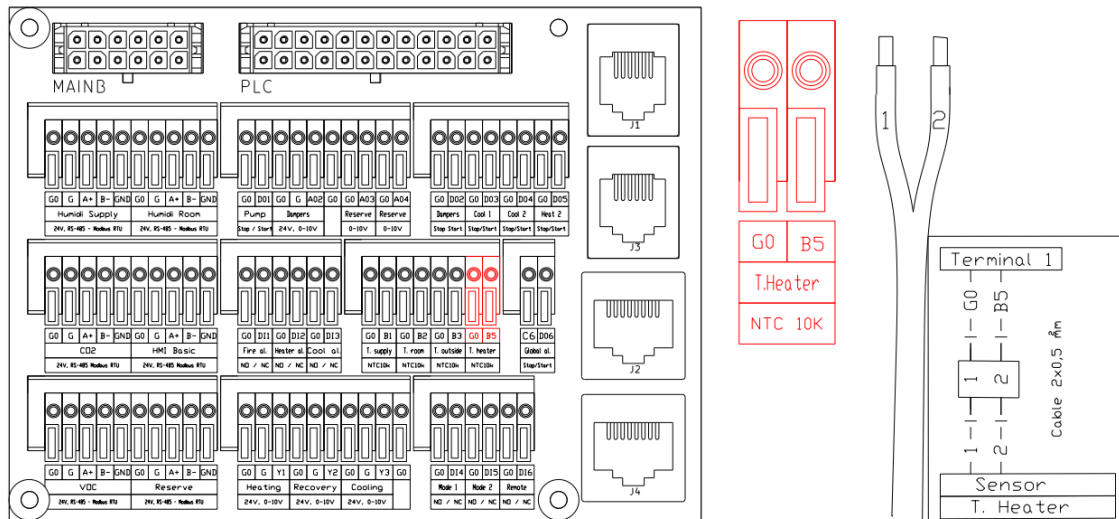

6.5 DIGITAL INPUTS

DIGITAL INPUTS

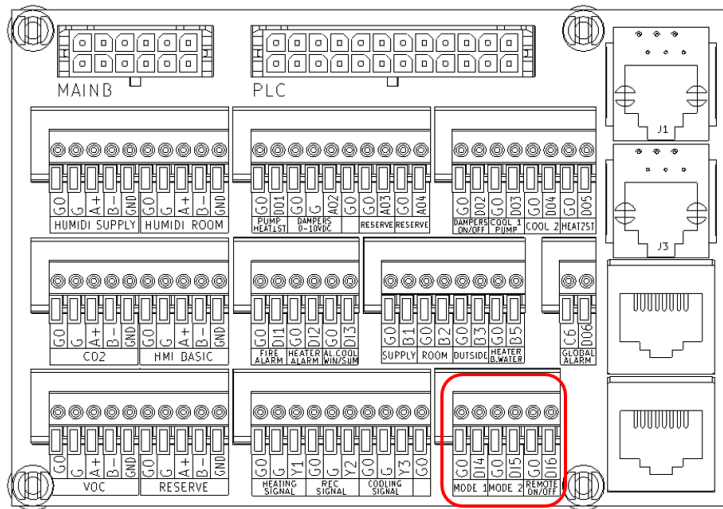

D11	Fire alarm
D12*	Heater alarm (freezing)
	Radiator alarm
D13	Humidifier alarm
D14	Cooling source alarm
D15	Programmable external input (to allow the operation of the panel or to force the selected operation mode)
Remote	

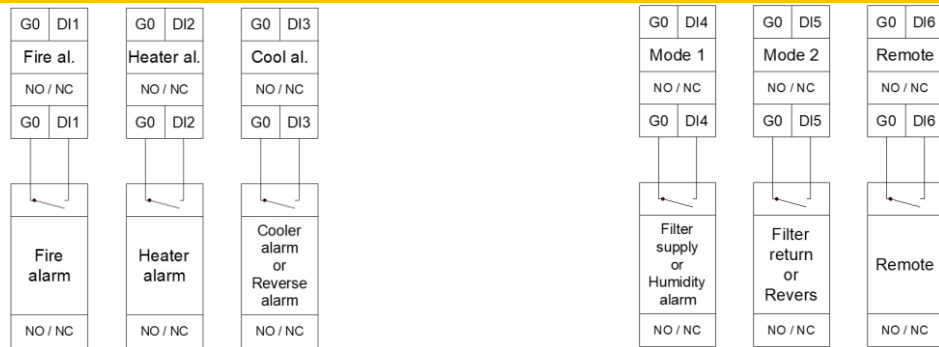

D12* - Heater alarm (freeze). In case of absence of water heater and presence of electric heater, the alarm signal is used for electric heater operation confirmation signal (A1/A2).

6.5.1 FIRE ALARM SIGNAL DI1

FIRE ALARM SIGNAL DI1

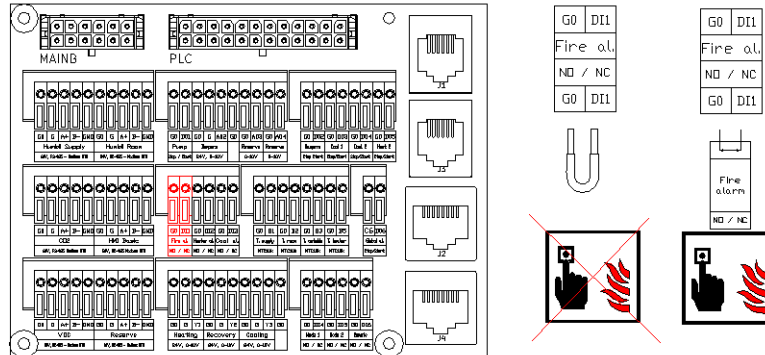

6.5.2 DI2 WATER HEATER FREEZE SENSOR

DI2 WATER HEATER FREEZE SENSOR

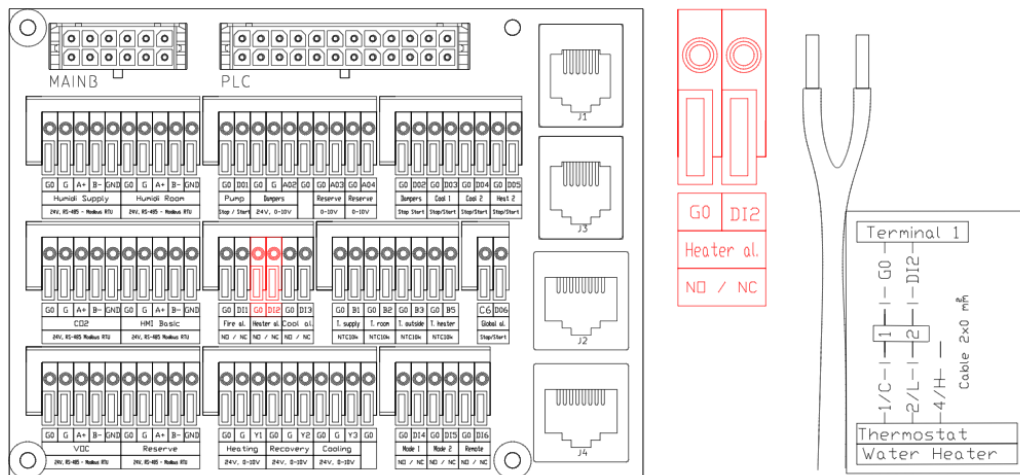

6.5.3 DI3 COOLING SOURCE ALARM

COLD SOURCE ALARM

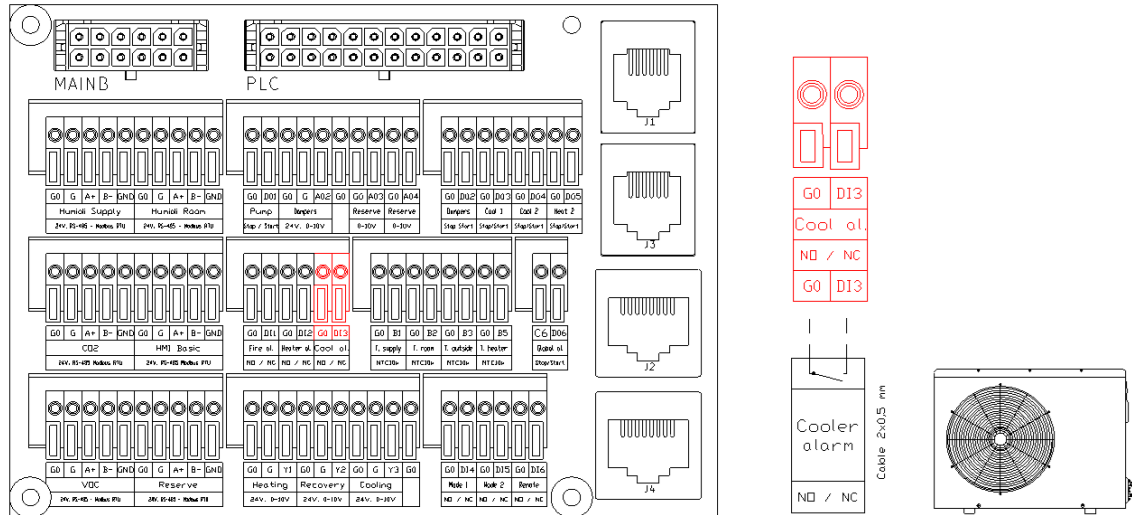

6.6 ANALOG OUTPUTS (0-10V DC)

ANALOG OUTPUTS (NTC10K)

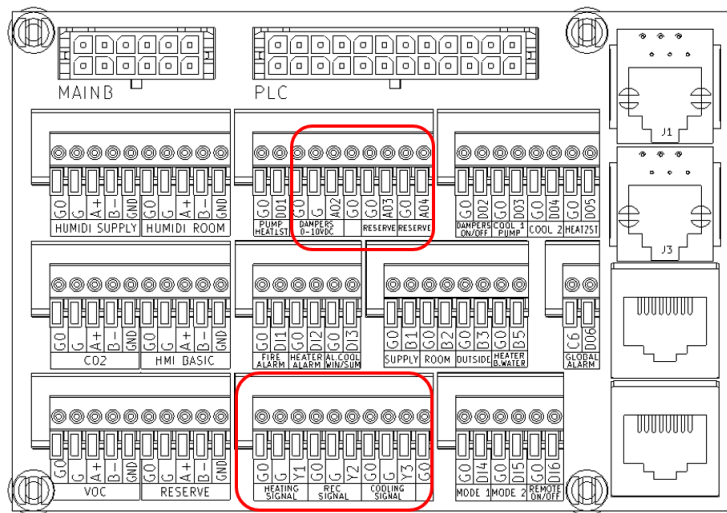

AO1*	Heat recovery
AO2	Air mixing
AO3	Humidification or secondary heater
AO4	Primary or secondary heater
Y1**	Main heater or secondary heater behind DX-H or mixing chamber
Y3***	Cooler or reheat after DX-H or mixing chamber

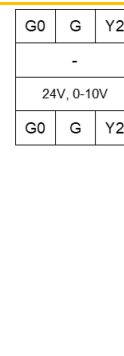
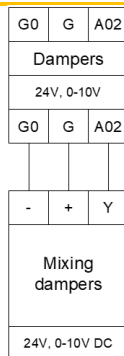

- A01* - factory connection outside terminal 1 (T1)
- Y1** - Priority: 1. Primary heater, 2. Secondary heater for heat pump (DX-H), 3. Mixing chamber,
- Y3*** Priority: 1. Refrigerator, 2. Secondary heater for heat pump (DX-H), 3. Mixing chamber,

6.6.1 WATER MAIN HEATER VALVE ACTUATOR AND ELECTRIC MAIN HEATER CONTROL SIGNAL Y1

WATER MAIN HEATER Y1

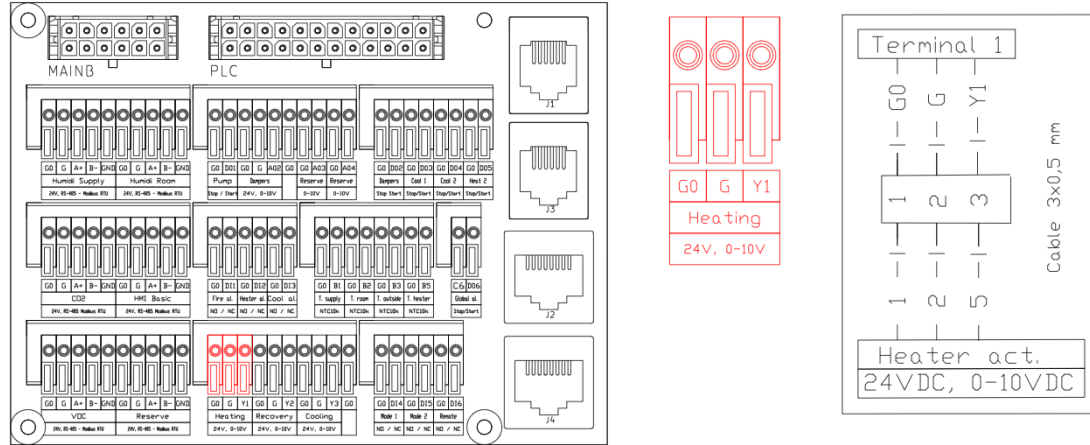

For the water heater, the control is connected to the valve actuator

6.6.2 ACTUATOR OF THE WATER PREHEATER OR SECONDARY HEATER VALVE AFTER DX-H Y1

Water pre- or post-heater behind DX-H Y1

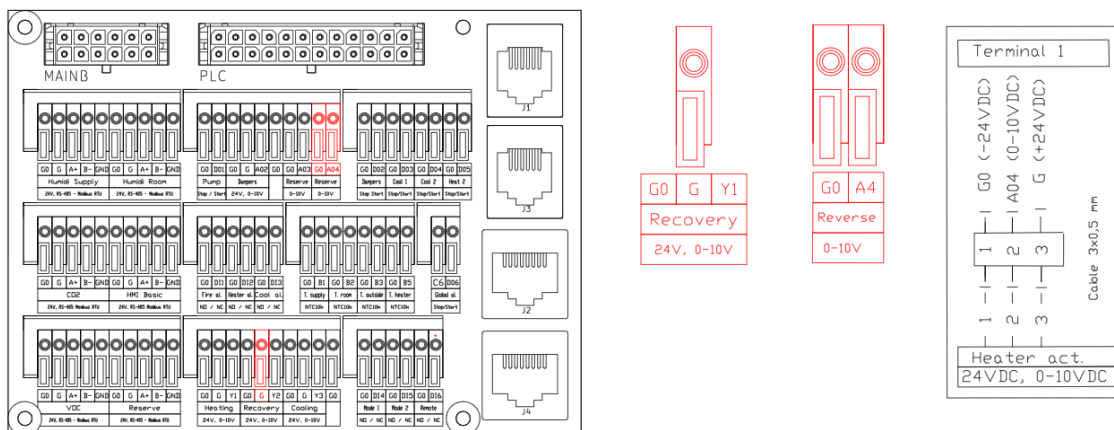

For the water heater, the control is connected to the valve actuator

6.7 DIGITAL OUTPUTS (24V DC)

DIGITAL OUTPUTS (24V DC)

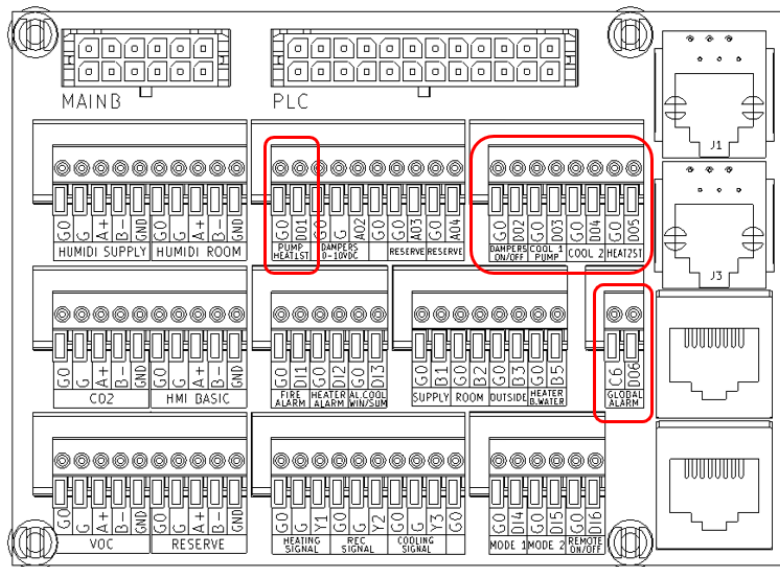

- D01 Primary heater (or secondary heater when there is a DX-H)
- D02 Air inlet and outlet passages
- D03 Stage 1-stage cooler or DX-H signal
- D04 Stage 2 cooler or stage 1 DX-H or humidifier or glycol recovery or redundant dampers
- D05 Heater stage 2 or DX-H stage 2
- D06 Primary heater or secondary heater or general alarm

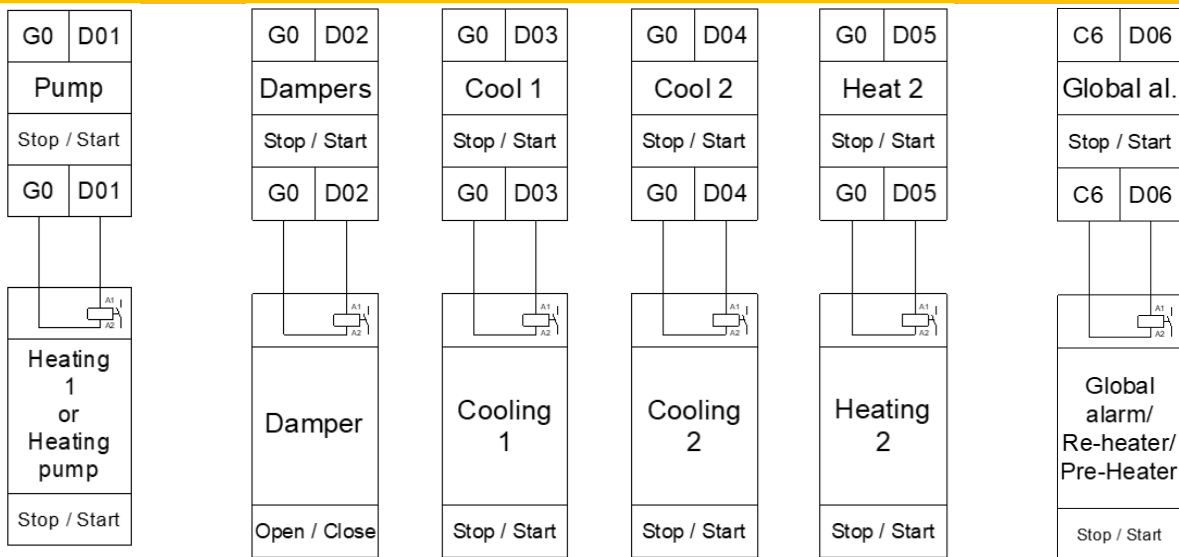

If it is necessary to use 230V AC voltage or potential-free contacts for output signals, use an isolation relay with a coil supplied at 24V DC from the relay outputs of the controller. The relay is not supplied with the device.

6.8 CONNECTION OF CONDENSING UNIT SIGNALS

EXCHANGER DX (0-10V CONTROL)

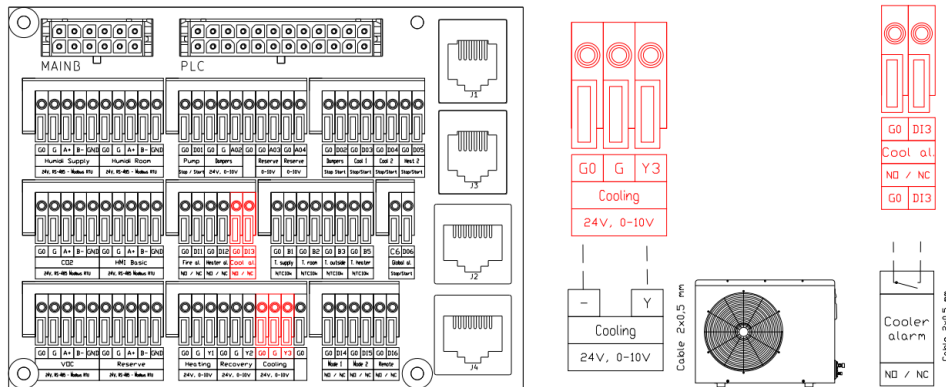

DX EXCHANGER (ON-OFF CONTROL)

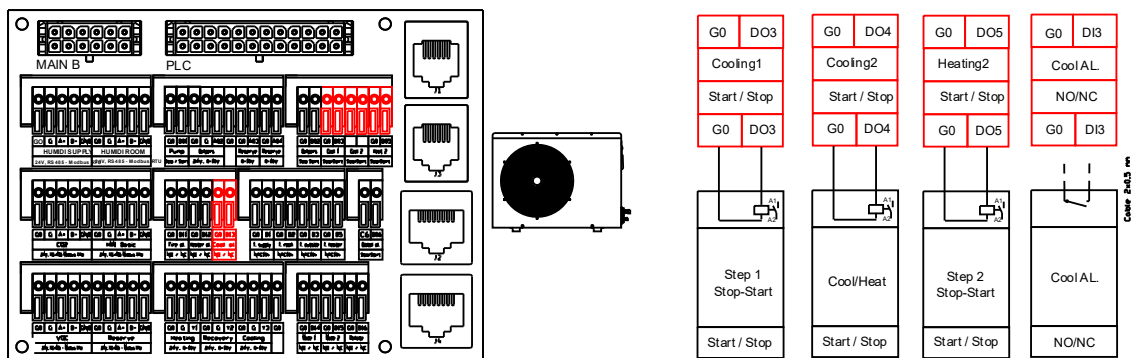

6.9 CONNECTION OF THREE-WAY VALVES

HEATER VALVE CONNECTION

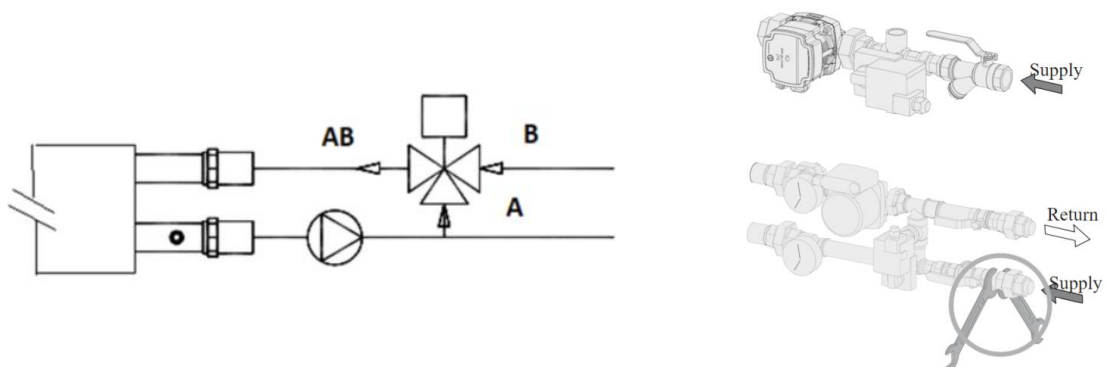

RADIATOR VALVE CONNECTION

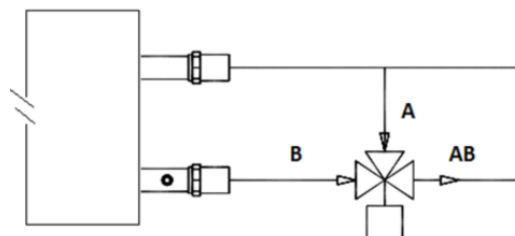

6.10 MODBUS RTU RS485 COMMUNICATION

MODBUS RTU RS485 COMMUNICATION

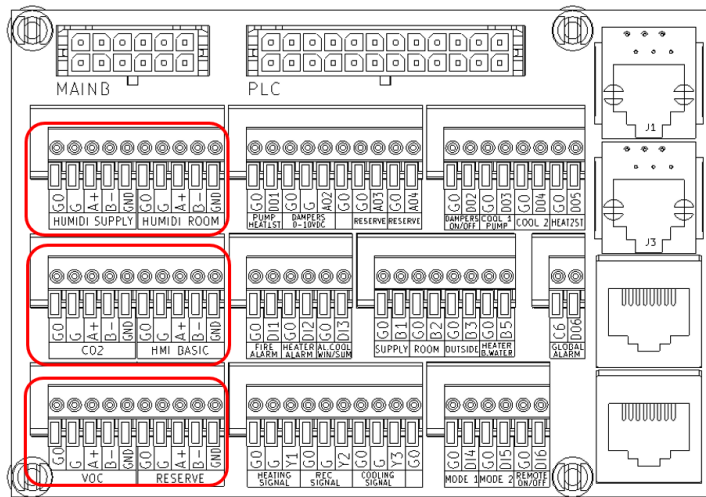

Moisture sensor - air supply

Humidity sensor - room (exhaust)*.

HMI Basic panel

CO2 sensor

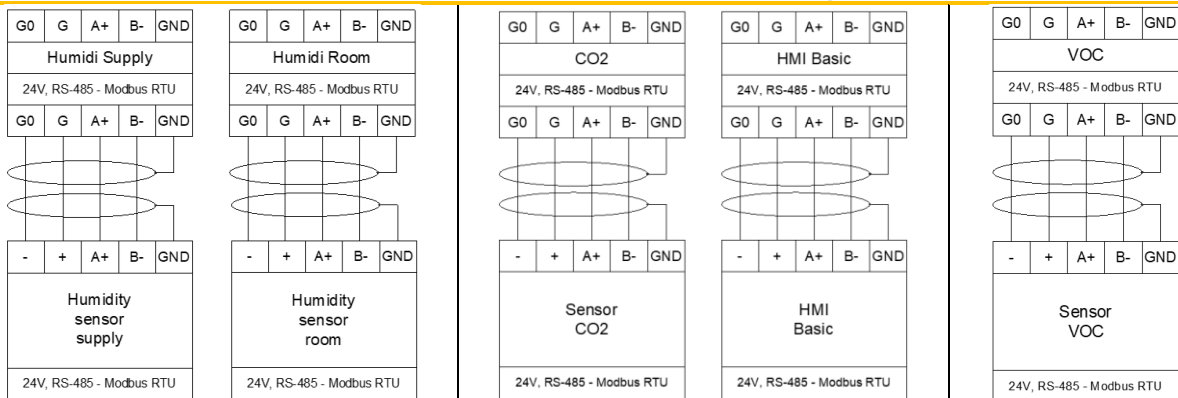

* Factory assembly.

6.11 CONNECTION OF OPERATOR PANELS

6.11.1 HMI ADVANCED

HMI ADVANCED

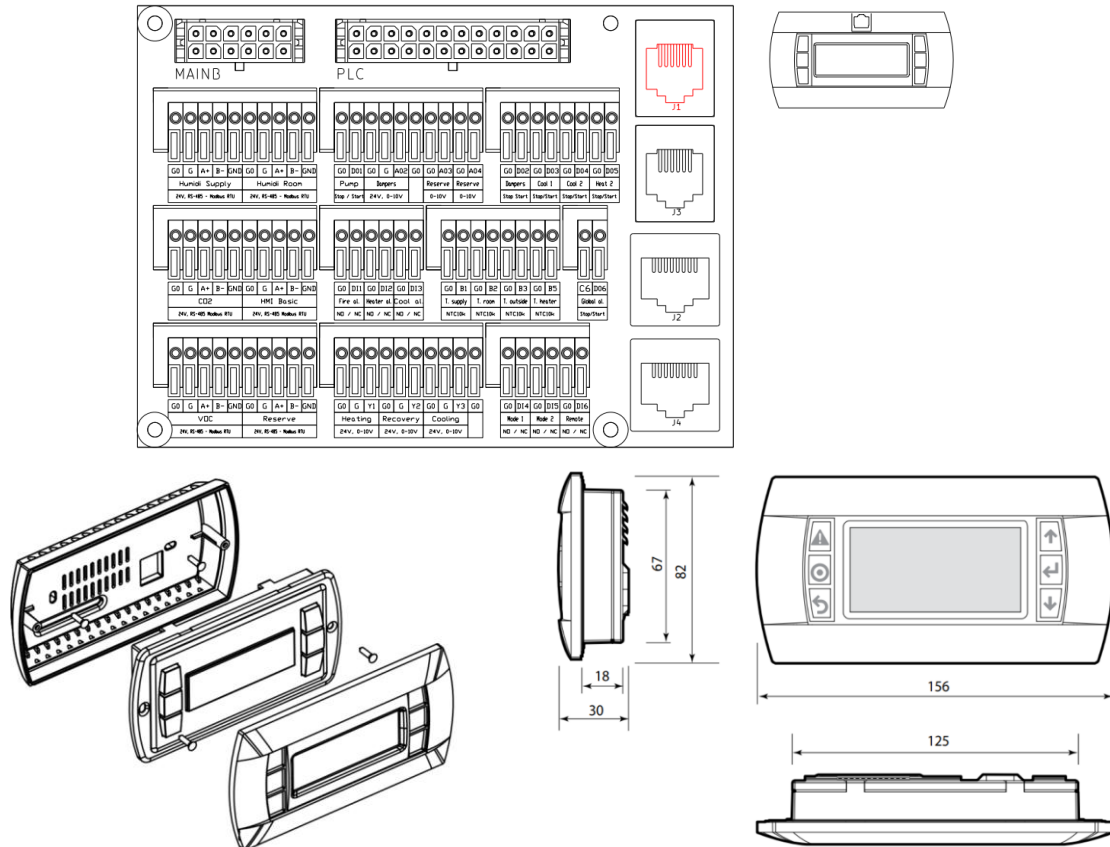

6.11.2 HMI BASIC

HMI BASIC 2HY

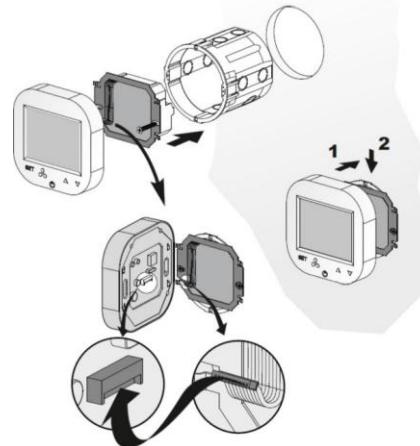
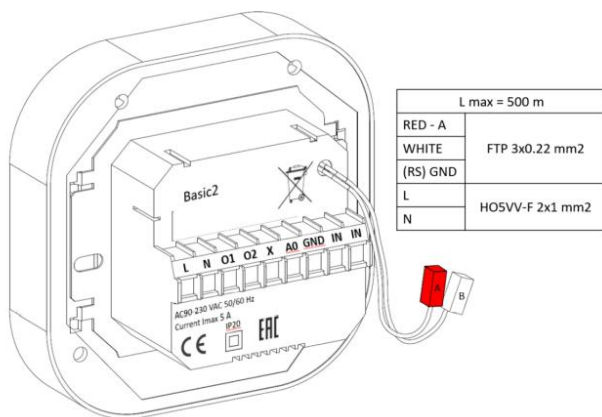
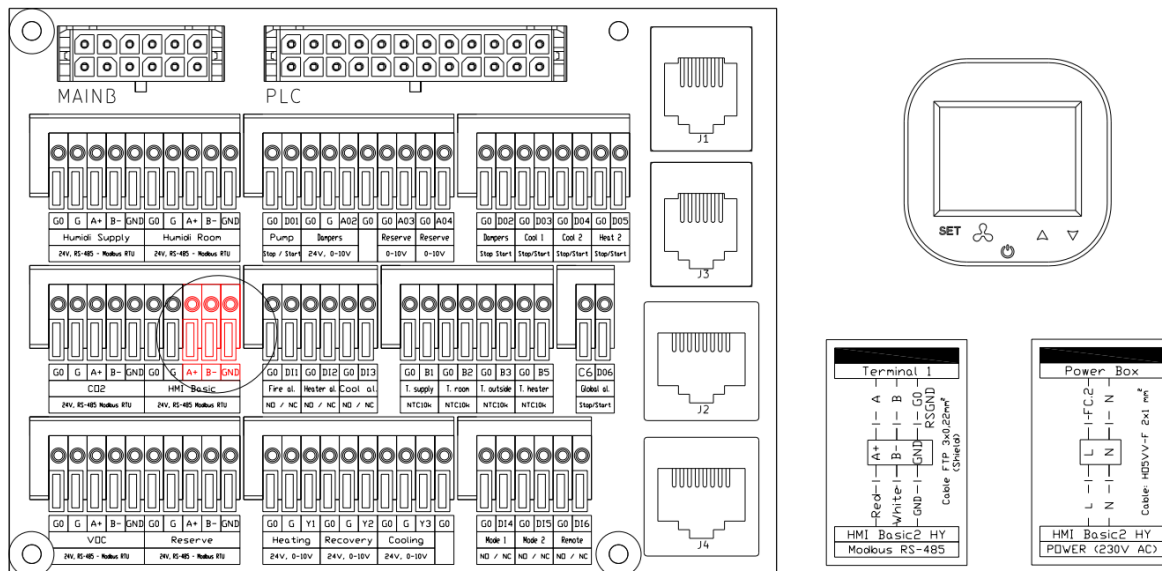

HMI connections are powered by 110-230V AC mains voltage. To ensure proper operation, use separate power and control cables, not exceeding the recommended length of 500m. The following types of cables are recommended:

- power supply: H05VV-F 2x1 mm²
- communication: FTP 3x0.22 mm²

6.11.3 WebHMI AND VMS

VENTUS MANAGEMENT SYSTEM



VMS - Ventus Management System -
visualization of control panel operation with WebHMI function

<http://192.168.1.111>

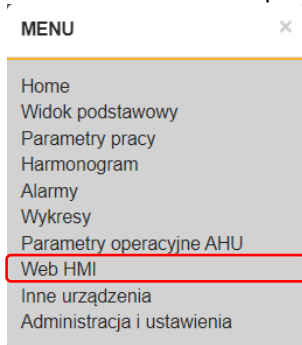

service



service

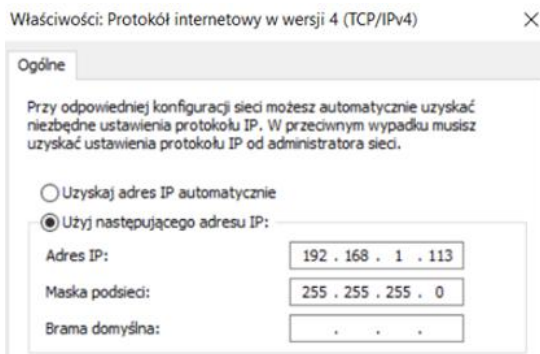

To connect the controller, it is required to set a fixed address **IP: 192.168.1.xxx**, where xxx is other than 111. Subnet mask **255.255.255.0**

6.11.4 BLUETOOTH MODULE

The Bluetooth module is designed for low-power Bluetooth V5.0 connectivity to mobile devices. The module transmits an RS485 [Modbus RTU] serial transmission signal from the main controller to the mobile device using the Bluetooth connection, thus eliminating the transmission cable. To use the Bluetooth module to control the VTS CONTROL control panel, install the dedicated mHMI application on the mobile device and connect to the dedicated mHMI Bluetooth module, which has been connected to the VTS CONTROL switchboard. For VENTUS COMPACT plug-and-play devices, it is installed at the factory, while for other devices it requires connection and configuration by the customer.

BLUETOOTH MODULE

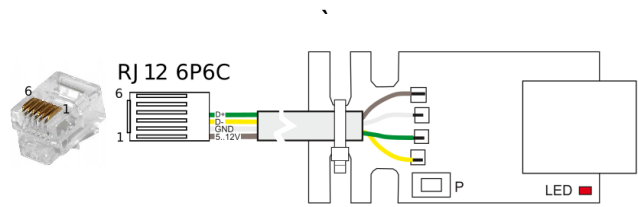
	Terminal	PIN	Designation
	0	=	grounding (stranded screened wire)
	1	1	+VRL 12V
	2	2	GND
	3	3	Rx-/Tx-
	4	4	Rx+/Tx+
	5	5	GNS
	6	6	+VRL 12V

Data transmission from RS485 [Modbus RTU] to Bluetooth V5.0.

Internally built-in antenna - does not require an external antenna or allow connection.

Power supply

Degree of protection

Ambient temperature

ISM transmission

Dimensions

Assembly

Electromagnetic environments

Degree of environmental pollution

Development conditions

- Due to electrostatic discharge, it requires housing to prevent access to the device during normal operation.
- Attach to the fixed components of the device installation. It should not be possible to approach the module to live parts under dangerous voltage.

P button for configuring serial communication data and pairing functions.

LEDs to indicate transmission and power supply.

5...12 VDC, 1 W (4A fuse)

IP 00

0° C...50 C°

Bluetooth V5.0, ISM 2.4 GHz, Transmission speed: 125 Kbps, 500 Kbps, 1 Mbps, 2 Mbps
60x22x5 mm

Stationary device for building in

Domestic or similar environment and industrial environment

2 according to IEC 62368-1

REQUIREMENTS:



- CONTROL software uPC3 as of 1.0.26
- Smartphone with systems from versions: Android 9, iOS 11
- Assignment of rights and activation:
 - location (related to bluetooth connection)
 - bluetooth connections

BT MODULE SUPPORT

The device allows other devices to connect through the broadcast system. The default name of the module by which it broadcasts is the factory number of the air handling unit. For devices with an unconfigured control panel number, the module reports as "AHU Bluetooth".

By default, the server allows only previously paired devices to connect, this state is indicated by a disabled LED with a pulse on.

You can allow all devices to connect by holding down the pairing button for about 3 seconds. The LED will then be on with a pulse off. The server can be connected to up to one client device at a time. A server that is actively connected to another device has its LED constantly on.

LED states:

- **Off** - offline mode / no power,
- **disabled with pulse** - server mode with disabled ability to connect new devices,
- **enabled with pulse** - server mode with new device connectivity enabled
- **enabled** - server mode with active connection



- The app includes a tutorial for pairing and connecting the device.

The mHMI smartphone application has been developed for service departments, as well as for about end users of *VENTUS*, *VENTUS COMPACT* and *VENTUS COMPACT TOP* air handling units. The application is available on: Play App Store and Apple App Store.

The application allows both the current change of settings and detailed configuration of the operating parameters of the control panel and its components. The intuitive interface makes it easy to set up the basic functions of the control panel, making operation of the control panel a pleasure even for a user with no previous experience.

CONFIGURATION OF THE UPC3 CONTROLLER - mHMI and HMI ADVANCED

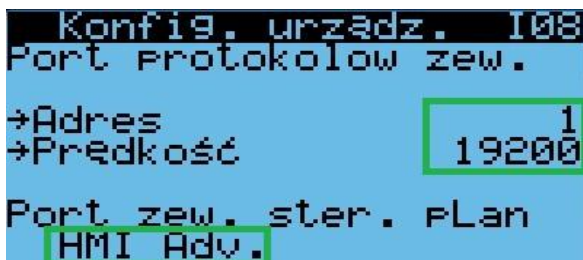
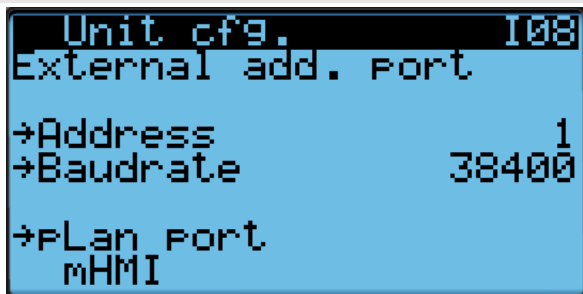

- "Address" - Address of the controller used for communication using the external protocol
- "Speed" - the speed (baudrate) of the external controller protocol.
- "External port of the pLan controller" - type of protocol used by the pLan port of the controller (RJ11 socket)

[for mHMI, the value of the pLan port parameter should be set to "mHMMI" accordingly].

- "Address" - Address of the controller used for communication using the external protocol
- "Speed" - the speed (baudrate) of the external controller protocol.
- "External port of the pLan controller" - type of protocol used by the pLan port of the controller (RJ11 socket)

[depending on the selected HMI, the value of the pLan port parameter should be set to HMI Advanced accordingly]

- The ability to modify the page requires access to a standard service password. You need to set the parameters according to the illustration

BLUETOOTH MODULE ACTIVATION

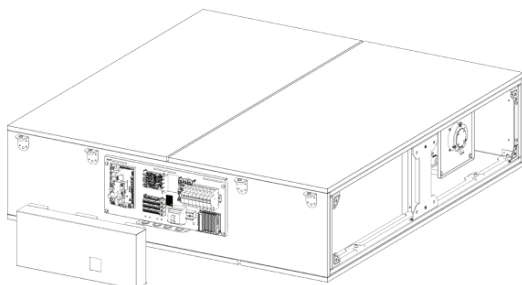

1. Unscrew the front panel of the power and control switchgear housing

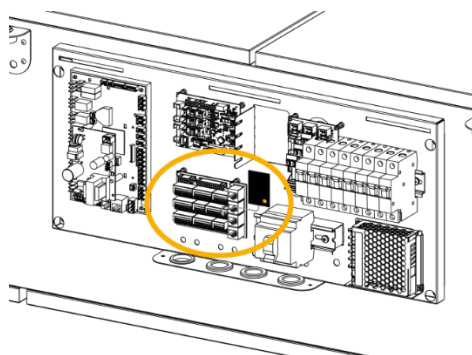

2. The Bluetooth module should be plugged into the uPC3 controller (if supplied separately it should be plugged in)

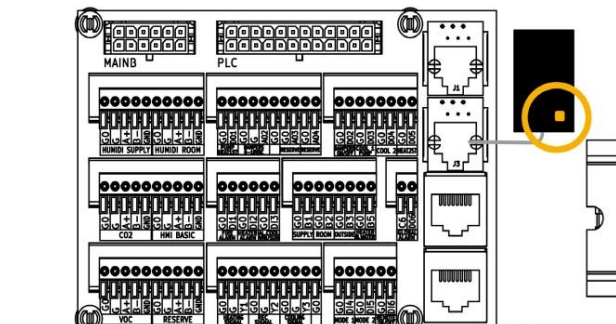

- Find the button on the Bluetooth (BT) module and press it until the LED starts flashing. This indicates that the BT is in pairing mode. Then go to the app and pair the PBX with the app. Pairing mode is active for 30s.

ADDING A DEVICE

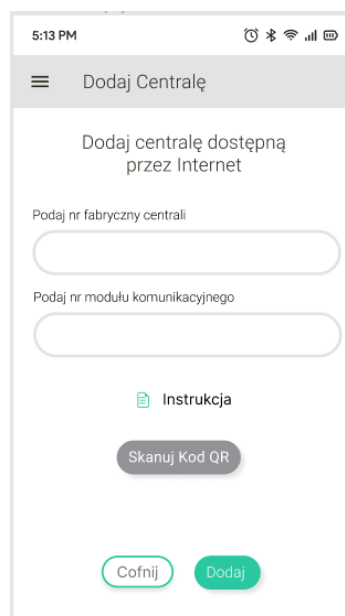
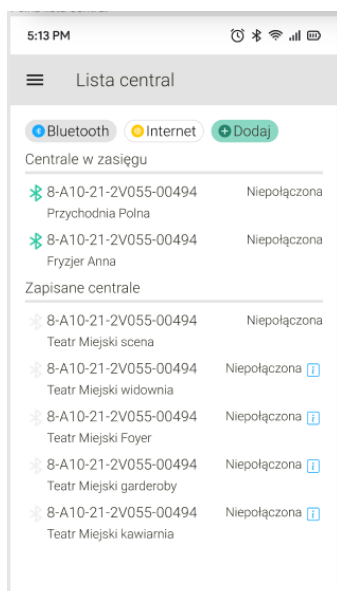

7 INITIAL START-UP OF THE DEVICE

7.1 PREPARING FOR THE FIRST LAUNCH



- ! Before proceeding with the activities leading to the first startup, read the manual of the operator panels.
- ! The air conditioning unit can only operate with filters installed.
- ! Replace air filters with clean ones after the first few hours of operation.
- ! The manual uses the mask graphics of the HMI ADVANCED operator panel. Masks in other panels may differ slightly from those shown in the manual.

7.1.1 CHECK THE CONDITION OF THE INSTALLATION

PRE-STARTUP ACTIVITIES

Correctness of application of the device	As part of the commissioning procedure, check that the air conditioning/ventilating/heating unit in question has been constructed and installed in accordance with the structural/installation design and the manufacturer's guidelines.
Completeness of installation	Verify the presence of all AHU features and accessories (filters, dampers, actuators, valves, heaters/coolers, etc.) based on the technical sheet - a complete list of AHU components can be found in the technical sheet of the AHU, as well as on the labels of individual delivery packages.
Connection to air ducts	Check that all ventilation equipment and its components have been mechanically installed and connected to the duct system.
Condition of air ducts	Check that the channels are clean and the adjustment elements on the channels are pre-adjusted.
Quality of installation at the facility	Check whether the functional systems and components of the equipment were not damaged during the installation or other activities, As well as CONTROL components,
Connection of external sources of cooling and technological heat	Check that the plumbing systems and freon installation is complete and ready for operation, and that the correct amount of heating or cooling medium has been introduced to start the air handling unit.

OPERATIONS BEFORE STARTING UP (cont'd)

Grounding installation	Check that grounding cables are installed, connecting control systems to ventilation ducts.
Condensate installation	Check that the condensate traps and condensate drainage systems from the condensate gutter are installed.
CONTROL peripherals	Check the connections of peripheral devices (T1 terminal) - since the optional equipment of the control panel, such as operator panels and some temperature sensors, may differ depending on the selected configuration, check that their connection is made through the dedicated T1 terminal, was made in accordance with the according to the documentation (pay special attention to the correct connection of the 24V power supply and Modbus communication wires, as their confusion may damage the entire communication bus of the control panel)
Electrical supply to the device.	Check the correct connection of the power supply to the main circuit breaker - voltage of the appropriate power must be supplied to the block switchgear in accordance with the wiring diagram of the device in the relevant section of its technical sheet or the User's Manual (DTR).
Electric heater	<p>Check the correct connection of the power supply to the electric heater (if any) - voltage of the appropriate power must be supplied to the heater switchgear in accordance with the wiring diagram of the device in the relevant section of its technical card or User's Manual (DTR).</p> <p>During the operation of the air handling unit (and also before its first startup), when the heater is not running, dust may settle on the heating elements. When the heater is switched on again, heavy soiling can cause the smell of burning dust or even a fire hazard.</p> <p>Regularly (annually), and especially before the first start-up and before the start of the heating period, check the condition of the electrical connections, the condition of the heating elements and how dirty they are. Remove any dirt with a vacuum cleaner with a soft squeegee or compressed air.</p> <p>The operation of the overheating protection and the no-airflow protection should also be checked regularly. The air speed in the AHU during heater operation should not be less than 1.5 m/s.</p>
Closing the inspection panels.	Check that the inspection panels are closed - the rotating parts of the control panel can be a health and life hazard when the protective covers are removed

7.1.2 CONFIGURATION OF DX AND DX-H (REVERSIBLE) EXCHANGERS

- ! If the unit is equipped with a DX chiller, which is connected to an external condensing unit, configure the number of cooling (heating) sections and the method of communication with the condensing unit.
- ! This item does not include the factory built-in heat pump.

The default parameters of the uPC3 controller for DX exchangers are suitable for most devices on the market. According to demand, you can change the parameters (regardless of the function and number of exchanger stages).

THE PERCENTAGE VALUE OF THE CONTROLLER, FORCING START / STOP OF THE DIGITAL OUTPUT / OUTPUTS RESPONSIBLE FOR ALLOWING THE OPERATION (screen A11 for heating, screen B05 for cooling)

Default values allow the DX motor to start quickly even at a low level of heating/cooling demand, followed by smooth control by changing the 0-10V signal, which works well for current exchangers with inverter motors. For DX systems with older-type motors (high-power motors without smooth control), the start threshold of the first stage can be set correspondingly higher (e.g., to 50%) to block allowing its operation at low demand for heating/cooling and thus avoid jump on/off cycles.

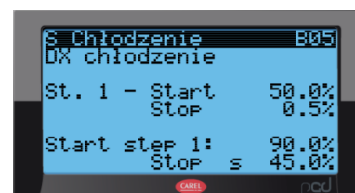
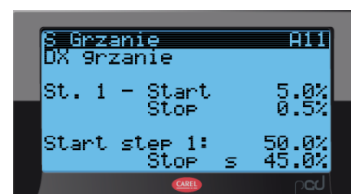

MINIMUM SYSTEM START-UP AND SHUT-DOWN TIMES AND MINIMUM INTERVAL BETWEEN

(screens A10/A14/A18 for heating, screen B04 for cooling)

Appropriate values of these parameters protect the DX circuit from too frequent state changes, which can cause temperature instability and shorten the life of its components. If the system is additionally protected by appropriate delays on the part of external CONTROL, these parameters in the controller can be reduced to single seconds to avoid overlapping wait times.

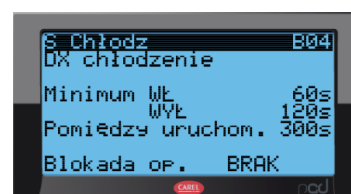
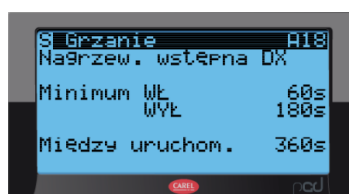
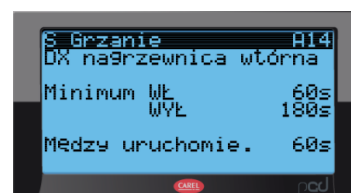
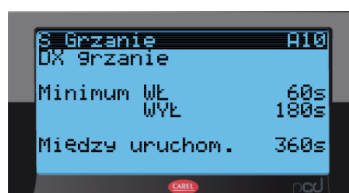

LOGIC OF DIGITAL OUTPUTS CONTROLLING THE DX CIRCUIT

(screens A01, A02, A05, A06 for heating, screens B01, B02 for cooling)

By default, all control digital outputs are treated as normally closed (NC) - it is possible to change this state to normally open (NO).

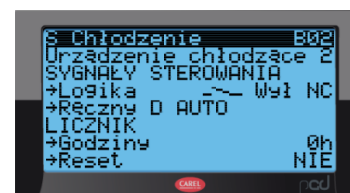
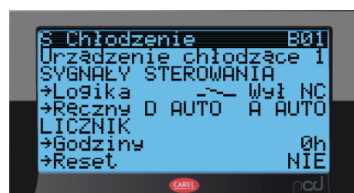
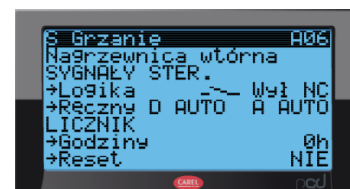
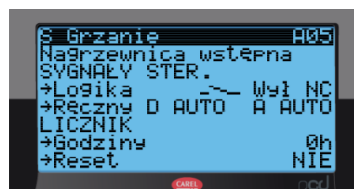
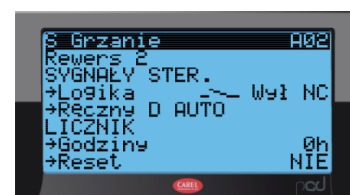
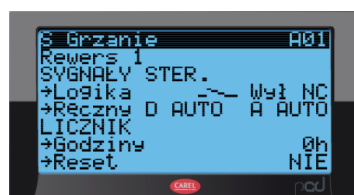

ADJUSTMENT OF VOLTAGE LEVELS CONTROLLING FUNCTIONS

(screen A22)

By default, the power control of both functions is implemented by the controller using voltages in the range of 0-10V, but if the target circuit is controlled with voltages of other levels (e.g. 2-10V, 0-5V) it is possible to adjust the output signals provided by the uPC3

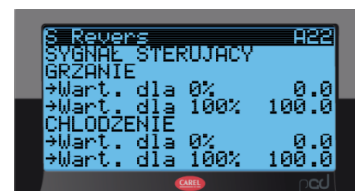

OPERATING PERMIT FROM TEMPERATURE

(screen A23)

Parameter with default value set to -20.0C, blocking the possibility of starting the system when the outside temperature is below the set temperature. It is intended to protect the DX system from operating in adverse weather conditions.

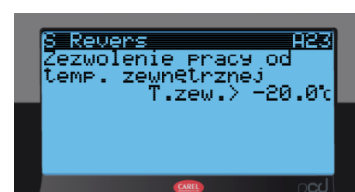

7.1.3 POWER CONFIGURATION OF ELECTRIC HEATERS

! If the unit is equipped with an electric heater, the heater's heating sections must be configured.

CONFIGURATION OF ELECTRIC HEATER POWER STAGES

Read the power distribution from the schematic or technical data sheet. For example, we have:

0-10V DC = 25%, ST2 = 25%, ST3 = 50%

This notation means that the step-adjustable part of a given heater is 25% of its power (0-10V DC). The second stage - step-attached (ST2) is also 25%, while the third stage - step-attached (ST3) is 50% of the total power of the heater.

These parameters should be reflected in the appropriate settings of the uPC3 controller. The settings are made on the HMI Advanced screens:

- A05 for preheater,
- A09 for the main heater,
- A06 for the secondary heater,

In the event that the circuit there is no one or both stages connected by step (no ST2 / ST3 markings on the schematic), in the controller settings, select the value of 0% in the appropriate position.

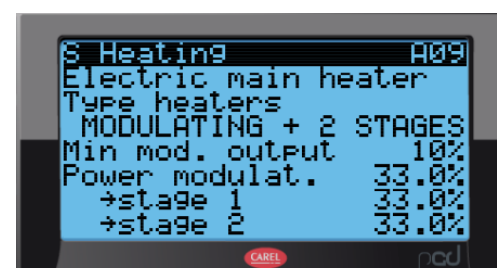
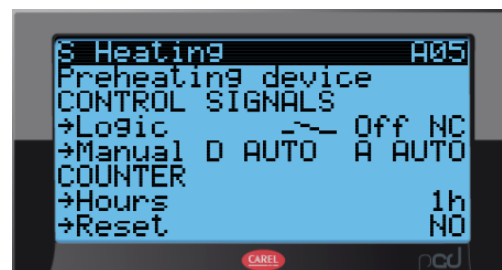

7.2 INITIAL START-UP

7.2.1 FACTORY PARAMETERS



- ! The control panel, which is supplied in the Plug&Play standard, has the CONTROL configured according to the parameters and criteria specified in the device selection sheet.
- ! In order to run the control panel in Plug&Play standard in factory parameter mode, no any additional configurations on the site are required (See "Preparing for the first startup").
- ! VTS CONTROL has a wide range of parameters for adjusting the operation of the device to the specifics of the installation at the facility. In order to improve the comfort of use, it is recommended to carry out such adjustment.

BASIC FACTORY CONFIGURATION

Application code configuration with consideration:

- The type and mode of operation of heat recovery
- The type and parameters of the main heater,
- The type and parameters of the preheater,
- The type and parameters of the secondary heater,
- The type and parameters of the secondary heater,
- The type and parameters of the reversible system,
- parameters of the mixing chamber,
- Humidifier operating parameters (control of moisture content in the air),
- HMI Basic, HMI Basic2 occurrences,

Configuration and settings:

- leading sensor,
- type of temperature control,
- type of humidity control,
- type of supply fan control (CAV/ VAV),
- type of exhaust fan control (CAV/ VAV)
- type of supply fan motor controller (EC),
- type of exhaust fan motor controller (EC),
- PID controllers for fans and other functions found in the application,
- number of supply fans,
- number of exhaust fans,
- supply impeller size,
- Exhaust impeller size,
- supply capacity,
- exhaust performance,
- Displacement pressure of the supply,
- The disposition pressure of go exhaust,
- maximum speed for the supply fan motor,
- maximum speed for the exhaust fan motor,
- Activation of the water heater touch sensor,
- Activation of the humidity transmitter
- Activation of the CO2 transducer (VOC sensor),

BASIC FACTORY CONFIGURATION - PROFILES (MODE) OF OPERATION					
PARAMETER			JOB PROFILES		
			Comfort	Economic	StandBy
			Comfort	Ekono	StandBy
Temperature	T	°C	22	22	22
Relative humidity - RH	RH*	%	50	50	50
Air quality - CO2 content	ppm	ppm	600	900	900
Supply capacity	V _S *	% m3/h	100	60	60
Exhaust capacity	V _E *	% m3/h	100	60	60

- Work profiles: Comfort, Economic require setting the time and date of their validity in the calendar.
- StandBy operation profile - requires setting parameters:
 - StandBy time i.e. the minimum time for which the AHU is awakened in StandBy mode,
 - Wake-up time, i.e. the time determining the interval between automatic wake-ups of the AHU in StandBy mode.
- * - humidity control requires the control panel to be equipped with humidification and dehumidification functions, otherwise, the values are read only,
- ** - 100% means the efficiency from the selection sheet.

7.2.2 CONTROL PANELS

PLUG&PLAY CONTROL PANEL STARTUP

Turn on the power of the control panel

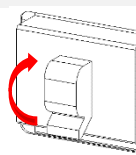
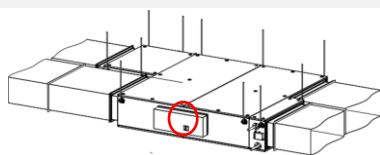

Physical

Virtual

Enable HMI Advanced*.

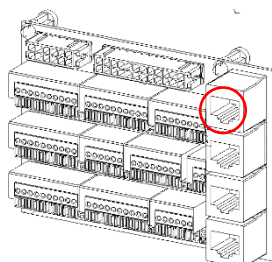

<http://192.168.1.111>

Switch OFF mode to any other arbitrary mode (work profile) according to .

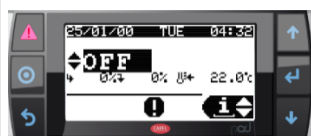

Changing the state of the device (operation mode)

OFF

Panel operation off (voltage reaches the panel)

ON

ECO

One of the user configuration profiles

OPTI

One of the user configuration profiles

COMF

One of the user configuration profiles

StBy

The state of readiness of the device for operation.

In the StBy state, the set room temperature is maintained. The fans are periodically activated to maintain the required air temperature. This mode is best at night when there is low or zero heat occupancy in the building.

AUTO

Operation of the device according to the schedule and calendar



- ! The startup of the control panel is absolutely blocked by a fire alarm, the tripping of the thermal protection of the fan motors, the triple tripping of the protection of the electric heater and the triple tripping of the antifreeze thermostat. Each of these events requires the cause of the alarm to be removed and then cleared.
- ! The correct operation of the power supply and the proper functioning of the BIOS is indicated by the illumination of the yellow and green LEDs on the PCB of the controller. The system is ready for operation after half a minute after the power is switched on.
- ! - * Changing from OFF to another mode is also available from HMI Basic 2.

7.2.3 HMI ADVANCED

HMI ADVANCED - NAVIGATION

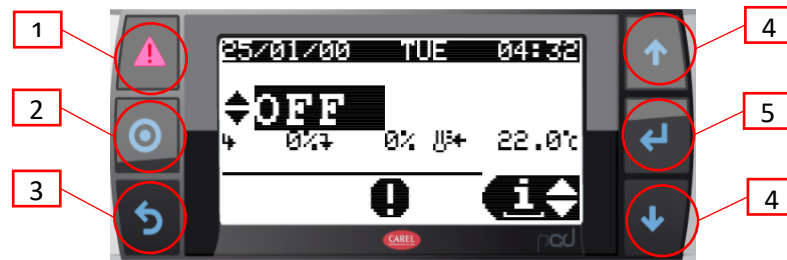

A

Simulation of equal presses in WEB HMI

1 "Alarm" button (call up active and archived alarms, delete alarms). When the alarm is active, the button is illuminated in red.

2 Button to change the operating modes (OFF/Auto/Low/Econo/Comfort). Confirmation with ENTER button.

3 ESC button (return to previous field or screen)

Arrows to navigate up and down and to change parameter values

UP:

- Moving up through the menu screens, (when the cursor remains in the upper left corner)

4

- Increasing the value of the parameter

DOWN:

- Moving down through menu screens, (while the cursor remains in the upper left corner)
- Decreasing the value of the parameter

ENTER button.

5

- selection of the parameter to be changed,
- transition to another parameter,
- validation of the selected value



! The parameters available in the LCD display window depend on the type of control panel and CONTROL system application. Therefore, for AHUs without a heater, you will not see options related to the heating section.

! The HMI Advanced cannot serve as a room temperature sensor.

HMI ADVANCED NAVIGATION cont.

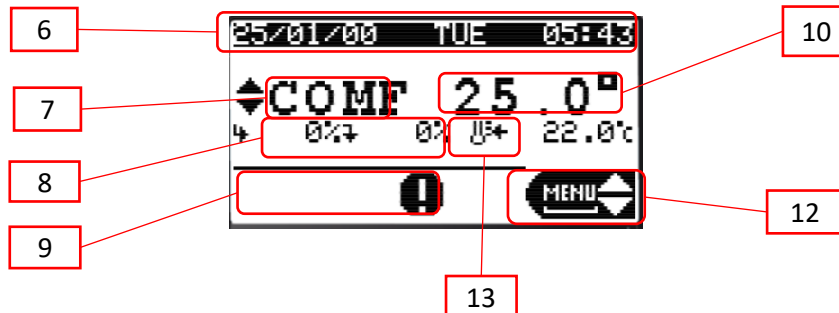

6	Current date and time.	12	HMI Advanced Work Module:
7	Current profile		<ul style="list-style-type: none"> • "Info" module (preview of the operation status of the control panel - available without logging in), • "Set" module (changing the settings of user parameters: capacity, temperatures, humidity, CO2 and setting the timer - available without logging in), • "Menu" module (allows you to make configuration changes to the control panel and its components and programming of EC motors, available only after logging in)
8	Current fan controllers		
9	Status of the air handling unit (running/stopping fans, heating/cooling, switching on recovery)		
10	Current value of the leading temperature		
11	Set leading temperature value		
13	Operating status icon:		
	Opening/closing throttles		Dehumidification
	Fan operation		Active recovery
	Heating		Detention on demand
	Cooling		Emergency stop
	Moisturization		Active calendar



- ! The parameters available in the LCD display window depend on the type of control panel and CONTROL system application. Therefore, for AHUs without a heater, you will not see options related to the heating section.
- ! The HMI Advanced cannot serve as a room temperature sensor.

7.2.4 HMI BASIC 2HY

HMI BASIC 2

HMI Basic 2 HY is a basic control panel, designed to operate VTS air handling units equipped with uPC3 controller. The functions realized are:

- Starting and stopping the control panel,
- mode selection,
- The ability to view and change the parameters of the various modes of operation (temperature, humidity, CO2 level, supply and exhaust fan speeds),
- Reading of leading, outside and room temperatures (built-in room temperature sensor),
- Setting AHU operation according to the schedule,
- handling of alarms (viewing, deleting)

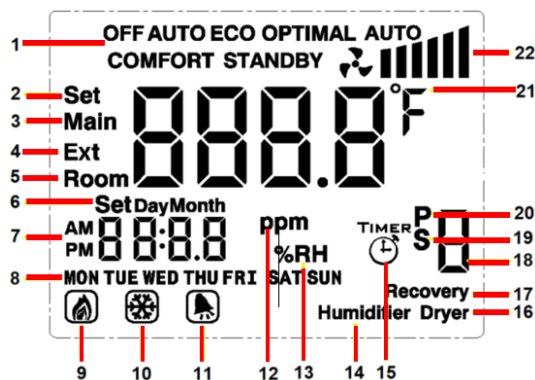

- | | | | |
|----|---------------------------|----|---------------------|
| 1 | Current mode of operation | 12 | Air quality |
| 2 | Setup temperatures | 13 | Moisture |
| 3 | Temperature leading | 14 | Moisturization |
| 4 | Outdoor temperature | 15 | Daily schedule |
| 5 | Room temperature | 16 | Dehumidification |
| 6 | Date setting | 17 | Retrieved from |
| 7 | Clock | 18 | Option number |
| 8 | Day of the week | 19 | Special Schedule |
| 9 | Heating | 20 | Periodic schedule |
| 10 | Cooling | 21 | Temperature unit |
| 11 | Alert | 22 | Fan operation level |

Current control of the operating level of the fans

Symbol	Fan control
	0 %
	0 < % ≤ 60
	60 < % ≤ 80
	80 < % ≤ 100

BUTTON	FUNCTION
	changing the operation mode / entering the setting menu / returning to the previous menu
	approve selection / move to next setting parameters / return to general setting menu
	switch between displayed temperatures / exit to home screen / turn off screen
	change of parameter values





- ! In the absence of communication with the controller, the HMI Basic 2 HY will only display the current room temperature.
- ! Activation of the panel in the settings of the air handling unit controller The panel is designed for air handling units equipped with uPC3 controller with software version 1.0.019 or higher. To activate its operation, from the level of HMI Advanced (physical, connected to the controller's pLAN port, or virtual, being part of the visualization application) go to the service menu and on the I01 screen change the last digit of the application code to 7.
- ! The default Modbus address of the HMI Basic 2 HY is 16. It can be changed on the I05 HMI Advanced screen (HMI Basic 2 line).
- ! If there is no communication between the AHU controller and the Basic 2 HY HMI, only the room temperature will be displayed on the HMI screen, and the controller will report the corresponding alarm (A1096).
- ! If there is no communication between the AHU controller and the Basic 2 HY HMI, only the room temperature will be displayed on the HMI screen, and the controller will report the corresponding alarm (A1096).

START-UP OF THE CONTROL PANEL - CHANGE OF THE OFF MODE TO THE ON PROFILE (ECO / OPTI / COMFORT)



On the main screen, hold down the button and  then use successive presses to select one of the modes (**Eco / Opti / Comfort**) and confirm the selection with  .

SWITCHING THE PANEL ON AND OFF

To turn off the panel screen, hold down the ON/OFF button . Turn it  on by briefly pressing the same button. Turning off the HMI panel is not the same as with turning off the panel - to turn off the AHU, select the Off mode.

The display backlight is automatically turned off after a user-defined time. Backlighting is activated by pressing any key. After backlighting, it is possible to perform further operations with the panel.





CHANGING THE PARAMETERS OF INDIVIDUAL MODES OF OPERATION

On the main screen, hold down the button and  then use successive presses to select the mode of interest (Standby / Eco / Opti / Comfort) and confirm the selection with  .

We now have the option to set the values of the parameters associated with the mode:



- the set temperature,
- moisture,
- CO2 levels,
- supply fan speeds (S),
- exhaust fan speeds (E).



Access to individual settings depends on the configuration of the control panel and its actual components.

Changes are made with   confirmed with . Exit to the  home screen automatically after a moment of inactivity or by pressing .

SETTING THE OPERATING SCHEDULE OF THE CONTROL PANEL

The HMI Basic 2 HY panel is equipped with the ability to set and modify the schedule of the control panel. Changes made from the HMIS BASIC 2HY panel also affect the schedule available in HMI Advanced and visualization - it does not constitute a separate calendar, but allows full access to the existing one.

On the main screen, hold down the button and  then select the Auto submenu with  successive presses and confirm the selection with the  button.

Use now to   select one of the schedules, which is confirmed with the key:

- **Timer** -  a daily schedule, allowing you to program up to 4 mode changes each day at a selected time, separately for each day of the week. Select in turn: the day of the week, activation (On / Off) of each action, the time at which it is to be performed and the mode to be set. Confirming the successive parameters, we move on to the parameterization of the next action (the digits 1-4 displayed on the right side determine which one we are currently setting).
- **P** - periodic schedule, allowing you to select up to 3 periods per year, during which the AHU is to operate in the selected mode (this type of schedule has a higher priority than the daily schedule). We select in turn: activation (On / Off) of individual periods, the date of their end, beginning and mode to be set. Confirming the subsequent parameters, we move to the parameterization of the next period (the digits 1-3 displayed on the right side determine which period we are currently setting).
- **S** - special schedule, allowing you to select up to 6 special days per year, on which the AHU is to operate in the selected mode (this type of schedule has a higher priority than the daily and periodic schedule). We select in turn: activation (On / Off) of a particular special day, its date and mode to be set. By approving the subsequent parameters, we move on to the parameterization of the next special day (the digits 1-6 displayed on the right side determine which one we are currently setting).
- **T** - not used

! Access to individual settings depends on the configuration of the control panel and its actual components. Output

! Exit to the home screen automatically after a moment of inactivity or by pressing .





ALARM HANDLING

MI Basic 2 HY allows you to view and clear active alarms. When an alarm is present, the main screen shows the bell symbol and the alarm number is displayed in place of the time.

Clearing the alarm, once the cause of the alarm has been removed, is done by holding down  .

PROGRAMMING MODE

With the display turned off by holding down the button, hold down the button to enter the programming mode (changing advanced parameters).

Subsequent presses of  switch between parameters, and use   to set their value. The menu is exited automatically after a moment of inactivity or by pressing  .

Parameter	Scope	Default value	Description
IP	1-255	16	Modbus-address
A1	2400/4800/9600	9600	Modbus - transmission speed
A2	0/1/2	0	Modbus - parity bit (0 = none, 1 = even, 2 = odd)
A3	12/24	24	Clock mode [h].
A4	00/01	00	Temperature units (00 = °C, 01 = °F).
A5	0-300	10	Screen backlight time [s]
A6	-9,9...9,9	0	Correction of built-in temperature sensor [°C].

SPECIFICATION

Type of device	control panel; regulator
Temperature measurement	0°C ... 70°C, 10k NTC
Support	physical membrane keyboard buttons
Communications	Modbus RTU (2400 / 4800 / 9600 bps)
Power supply	110-230V AC
Power consumption	1.5 VA
Display	backlit, graphic LCD
Design	ABS + polyester
Dimensions (S x W x G)	86 x 86 x 17 mm
Permissible Operating Temperature	0°C ... 50°C
Destination	for indoor installation (IP20)
Assembly	in a standard Ø60 installation box on a mounting bracket
Mass	150g



- ! In the absence of communication with the controller, the HMI Basic 2 HY will only display the current room temperature.
- ! Activation of the panel in the settings of the air handling unit controller The panel is designed for air handling units equipped with uPC3 controller with software version 1.0.019 or higher. To activate its operation, from the level of HMI Advanced (physical, connected to the controller's pLAN port, or virtual, being part of the visualization application) go to the service menu and on the I01 screen change the last digit of the application code to 7.
- ! The default Modbus address of the HMI Basic 2 HY is 16. It can be changed on the I05 HMI Advanced screen (HMI Basic 2 line).
- ! If there is no communication between the AHU controller and the Basic 2 HY HMI, only the room temperature will be displayed on the HMI screen, and the controller will report the corresponding alarm (A1096).
- ! If there is no communication between the AHU controller and the Basic 2 HY HMI, only the room temperature will be displayed on the HMI screen, and the controller will report the corresponding alarm (A1096).

7.2.5 mHMI APPLICATION

ACTIVATION OF THE DEVICE

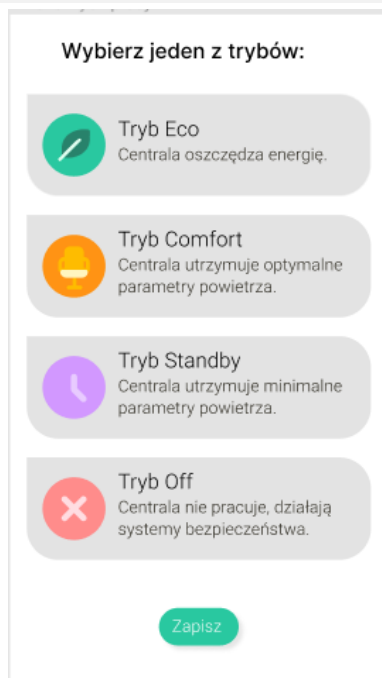
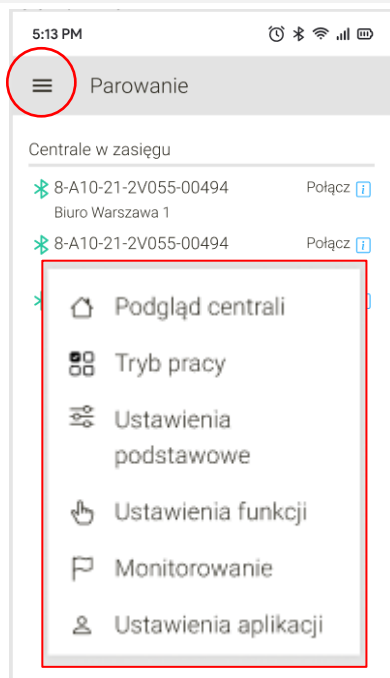

Select a paired device

Then, in the Menu, select one of the operating modes Operation Mode "On":

- Eco
- Comfort
- Standby
- Auto

Save your selection

REVIEW OF SELECTED ASPECTS OF THE mHMI APPLICATION



- The app includes a tutorial for pairing and connecting the device.

PANEL PREVIEW

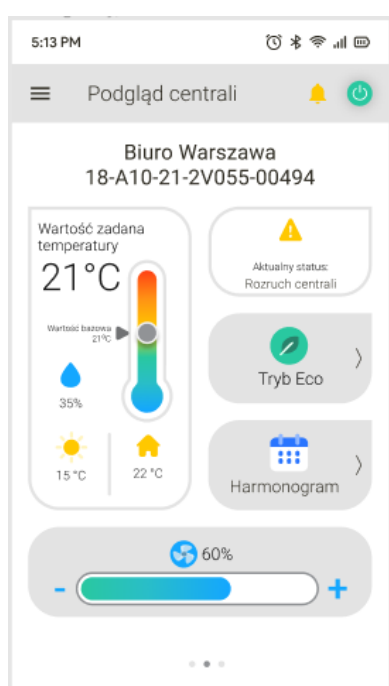

The PBX Preview view places the basic parameters of the PBX operation :

- outdoor air temperature,
- indoor air temperature,
- Set air temperature (leading sensor),
- Degree of fan speed control,
- HQ status,
- selected operation mode of the control panel: (eco, opti, comfort, auto, off)

Changing the set temperature

After clicking on the Thermometer icon, the user can smoothly adjust the temperature within limits depending on the mode.

Changing the operation mode of the control panel

After clicking on the Modes icon, it is possible to change the current mode, as well as change the settings for the mode.

Change of Work Schedule

After clicking on the Schedule icon, it is possible to change the time settings with the assignment of modes to the harmonogram.

Changing fan speeds

In the bar at the bottom of the screen, it is possible to change the fan speed settings (within the settings specific to the operation mode). This can be done by clicking on + or - .

OPERATING MODE PARAMETERS

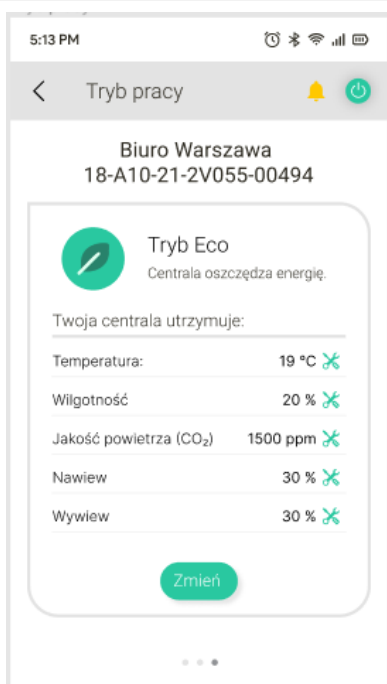

The Mode window presents the basic parameters pertaining to a particular mode and allows their quick editing.

WORK SCHEDULE - CALENDAR

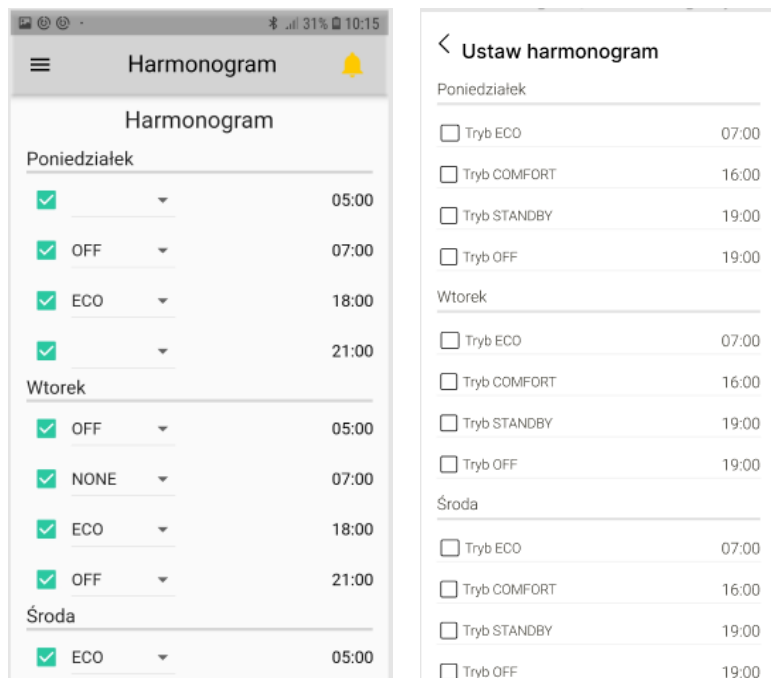

When you select the Schedule icon, there is an option:

- edit the days of switching on/off the control panel,
- Establish hourly intervals for the operation of the switchboard,
- mode assignment for a given time interval .

ALARMS



The list of alarms is visible under the 

Alarms can be opened in one of two views:

- Current alerts,
- Historical alerts.

The list of historical alarms shows a preview of alarms that are not currently active.

If there is a situation affecting to activate the alarm it will be shown in the list of active alarms. Then the application screen will turn red, to inform the user of the required response.

The "Reset" button clears all alarms on the screen - current and historical.

If there is an active alarm it will reappear in the current list.

FUNCTION SETTINGS - ADVANCED FUNCTIONS

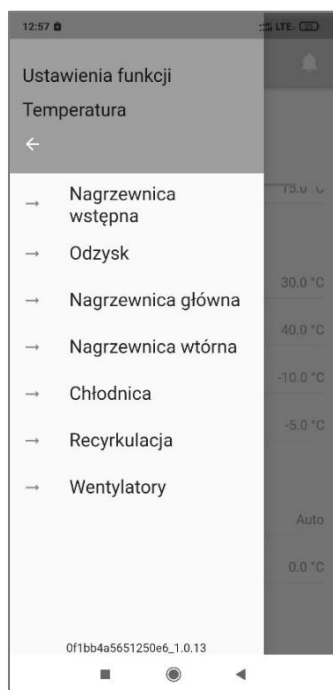

FUNCTION SETTINGS - this section of the menu gives you the ability to view and edit the operating parameters of the control panel related. In addition, you can access the control of individual inputs and outputs located on the control panel controller, as well as on the expansion board.

TEMPERATURE - The temperature settings section contains settings for all possible components that affect the resulting supply temperature.

FUNCTION SETTINGS - ADVANCED FEATURES (cont'd)

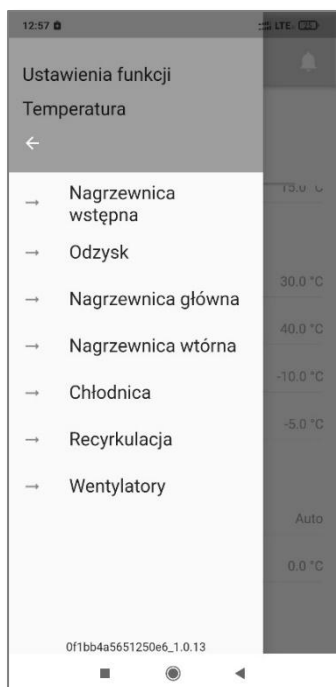

- **PRIMARY HEATER** - settings of preheater operating parameters, among others, PID, start and stop points (if available in the control panel).
- **RECOVERY** - parameter setting for the heat exchanger.
- **MAIN HEATER** - settings of operating parameters of the main heater (if available in the control panel).
- **SECONDARY HEATER** - settings of secondary heater operation parameters (if available in the control panel).
- **COOLER** - settings of operating parameters of the cooler (if available in the control panel).
- **RECYCLATION** - settings for the air recirculation function (if available in the control panel).
- **VENTILATORS** - settings for fan speed, PID algorithm, fan start and stop delay time, among others. CAV/VAV control.
- **MOISTURE** - possibility to set, among other things, PID parameters of the humidification process, extreme points for the start and end of humidification.

FUNCTION SETTINGS - ADVANCED FEATURES (cont'd)

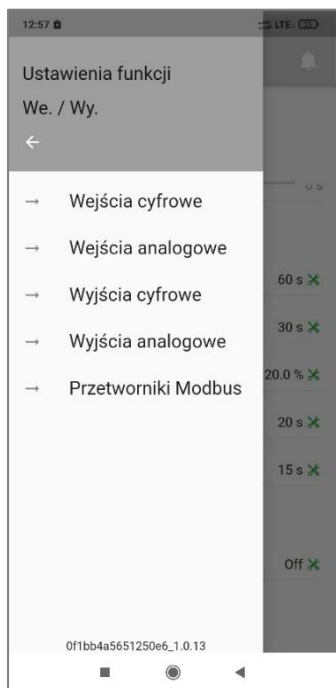

I/O. - Configurable inputs and digital and analog outputs and analog as well as ModBus signals. Inputs and outputs have been marked with the functions they are assigned to, e.g. DI1 - Fire alarm - is a digital input responsible for the fire alarm.

- Digital inputs,
- Analog inputs,
- Digital outputs,
- Analog outputs,
- Modbus transducers - ability to view and edit parameters related to transducers: pressure, humidity, CO2,

FUNCTION SETTINGS - ADVANCED FEATURES (cont'd)

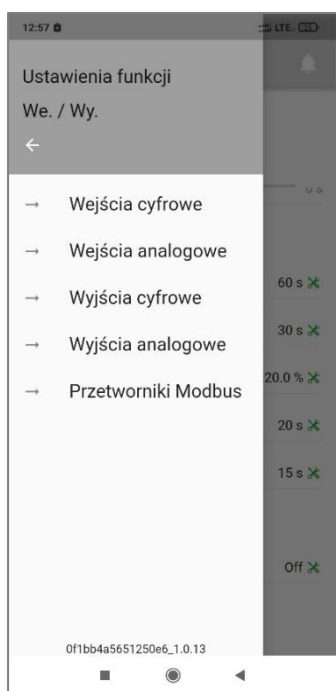

I/O EXPANSION MODULE

- Main board - allows you to read the parameters of signals connected to the main board of the control panel, activation/deactivation of the expansion board, as well as to set values such as : maximum pressure values, pressure offsets,
- EC PCB - it is possible to change the settings of inputs and outputs present on the PCB board
- HMI Basic - allows editing of settings related to the HMI Basic panel

UNIT

- Adjustmen
- BMS - variables used in communication with BMS systems
- Access levels - there are 3 levels of access: user, service technician and manufacturer.

MONITORING

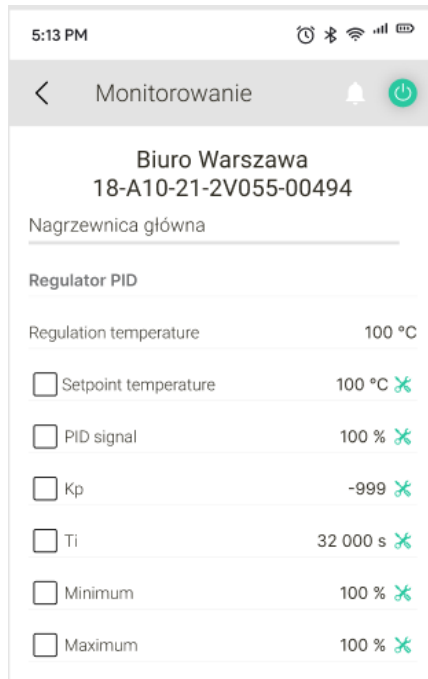

MONITORING

The user has the ability to define a quick view list of selected parameters.

To use this functionality, the user must save the selected parameters in the MONITORING section

APPLICATION SETTINGS

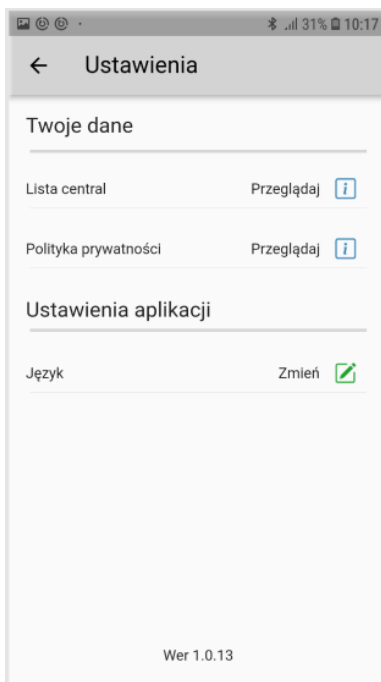
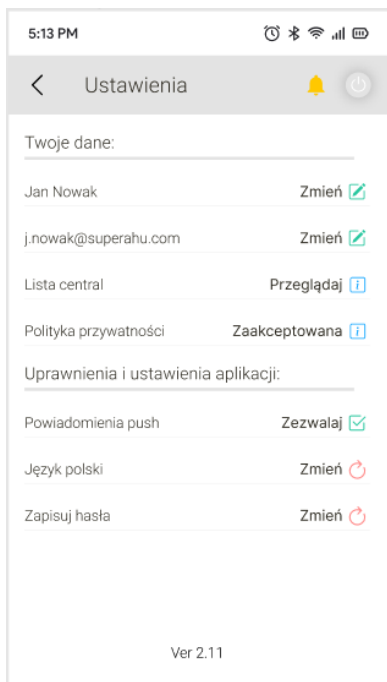

APPLICATION SETTINGS

Section of general settings that are not related to work parameters. Here it is possible to min:

- To give a custom name to the connected PBX,
- display a list of exchanges saved and currently detected by the bluetooth module,
- changing the language of the application,
- restore the factory settings of the control panel,
- Changes in display units for parameters.

7.2.6 OPERATING MODES OF THE CONTROL PANEL

OPERATING MODES OF THE CONTROL PANEL	
OFF	Air handling unit off - fans stopped, air dampers and control valves closed all sensors and measuring devices remain active - to protect the air handling unit from damage, such as fire alarm, anti-freeze protection.
AUTO	PBX operation dependent on calendar programming
LOW	Lower economy mode - Fan speed as well as dead zone in temperature control are adjustable. The temperature control algorithm can use a wide dead zone, while the fans can be set to low speed to reduce energy consumption.
EKON	higher economy mode - Fan speed as well as the insensitive zone in temperature control are adjustable. The temperature control algorithm can use a narrower insensitive zone, while the fans can be set to a higher speed to optimize energy consumption.
COMFORT	Factory setting of selection parameters. The settings can be modified by the user.
HMI BASIC	Basic mode - external control signals (binary inputs) of critical temperatures, such as too low a temperature, causes the control panel to start and immediately heat the room.

7.2.7 VERIFICATION OF OPERATION DURING INITIAL START-UP

During the initial startup, it is recommended to perform the steps listed below.

CHECKING THE OPERATION OF THE FANS

Check that the fans do not make excessive noise (make sure that the impeller does not rub against the hopper and that there are no foreign bodies within the fans' operating range, which may arise as a result of improper transportation or storage conditions),

CHECKING THE OPERATION OF AIR DAMPER ACTUATORS

- Check whether they close and open completely without resistance (this can be done by observing their operation during startup/shutdown of the control panel or by pressing the button on the actuator to release its locking mechanism and manually moving the laths),
- Check that they open and close in the correct direction (when the control panel startup sequence is activated, the dampers should open, and when the control panel is switched off - check that they work in the correct order at the moment - the actuators are equipped with a button to change the direction of operation in case of wrong direction),
- In the case of actuators with 0-10V signal, it is necessary to check if they work correctly in the full range (0-10V actuators are always used for passive bypass of recovery and dampers of the mixing chamber - in the case of an air handling unit with a mixing chamber, additionally supply and exhaust dampers can be smoothly controlled with 0-10V voltage). - this can be done by observing its operation during the operation of the air handling unit, or manually giving the control signal to the appropriate screens of the mixing chamber or recovery controller (set D to ON and A to the selected percentage value).

```
S Mixing Damper E01
Eco damper
CONTROL SIGNALS
→Manual D AUTO A AUTO
```

```
S Recovery D01
Recovery device
CONTROL SIGNALS
→Logic ~ Off NC
→Manual D AUTO A AUTO
COUNTER
→Hours 0h
→Reset NO
```

CHECKING SENSOR READINGS

- check that the readings from temperature, pressure, CO2 and humidity sensors are correct (at the beginning, when the air handling unit is powered but not running, the temperatures sent to the controller from the temperature sensors should oscillate in the range of ambient air temperature of the air handling unit, while the other transducers and sensors should show values typical for the environment - for example, most often for the CO2 sensor will be values below 600ppm for fresh air and initially zero values of flow and pressure before starting the fans on the pressure of the transducers, their values should change accordingly within the expected range once the unit is set up for operation).

```

I/O status Sc01
Temperatures
B1 Supply 0.0°C
B2 Return 0.0°C
B3 External 0.0°C
B4 Recovery 0.0°C
B5 Water heat 0.0°C
  
```

```

I/O status Sc02
Temperatures
B6 Rec. Supply 0.0°C
Water preheat 0.0°C
After preheat 0.0°C
TH Room 0.0°C
  
```

```

I/O status Sc03
Humidities
Room 0.0%rH
Supply 0.0%rH
Return 0.0%rH
  
```

```

I/O status Sc04
Pressures
Supply 0.0Pa
Return 0.0Pa
  
```

```

I/O status Sc05
Return CO2 value 0.0PPM
  
```

```

I/O status Sc38
Pressure filters
Supply 0.0Pa
Supply 2 0.0Pa
Supply 3 0.0Pa
Return 0.0Pa
Return 2 0.0Pa
  
```

CHECKING THE OPERATION OF WATER HEATER VALVE ACTUATORS

Check whether the actuator of the heater valve responds to the control signal - manually set the valve from the service menu of the controller and observe whether it causes the valve to open / close, respectively. To do this, set parameter D to ON and parameter A to the selected percentage on the corresponding screen in the service menu, depending on the type of heater you have and the function it performs [screens A01, A03, A05, A06. (See "UPC3 CONTROLLER MASK DESCRIPTION")

OPERATION OF WATER COOLER VALVE ACTUATORS

Check whether the cooler valve actuator responds to the control signal - manually drive the valve from the service menu of the controller and observe whether it causes the valve to open / close, respectively. To do this, set parameter D to ON and parameter A to the selected percentage on screen B01 of the controller. (See "UPC3 CONTROLLER MASK DESCRIPTION")

CHECK THE OPERATION OF THE WATER HEATER CIRCULATION PUMP

Check whether the heater circulating pump responds to the control signal - manually set the valve from the service menu of the controller and observe whether it causes the pump to switch on/off accordingly.

! Be sure to restore the original settings of the D and A (Auto) parameters after the test is performed

7.2.8 MEASUREMENT OF AIR VOLUME

Air volume measurement is an essential measurement for:

- Commissioning and technical acceptance of the air conditioning unit,
- If the system does not work according to requirements and expectations,
- Periodic inspection of the operation and efficiency of the air conditioning unit,
- Replacement of fan assembly components.

Before taking measurements and making adjustments, make sure that the dampers on all grilles or gates are set as designed.

Determining the amount of air flow is most often based on measuring the average velocity of air flow in a test cross-section of a duct. One of the most common methods for determining the average flow velocity is the cross-sectional sounding method using a Prandtl tube and measuring the flow velocity-related average dynamic pressure.

The key factors that affect measurement accuracy are

- The position of the measured cross-section in relation to the elements that cause distortion of the flow velocity (elbows, orifices, tees, butterfly valves, etc.),
- The number and location of test points in the measured section,
- stable and constant airflow,

The measurement should be carried out in a section of the duct with parallel walls and straight sections, at least 6 times the hydraulic diameter of the duct or the corresponding diameters in front of the test point and no less than 3 diameters behind it. In a real ventilation system, finding such a long straight element may be a problem. In this case, the location of the cross-section should be determined at the point where the least flow disturbance is expected, while increasing the number of measurement points. The location of the measuring cross section should be determined at the system design stage.

As an estimate, the measurement result is considered sufficient if it does not differ by more than $\pm 10\%$ from the design quantity. In the case of larger discrepancies, approximation of the measurement result to the design value can be achieved by

- Adjusting the network of ventilation ducts
- changing the setting of the main throttle
- changing the fan speed

7.2.9 THE MOST COMMON ADAPTIVE CHANGES OF PARAMETERS TO THE NEEDS OF THE FACILITY

FUNCTION	SCREEN	SCOPE OF CHANGE	WHEN TO CHANGE
MAIN HEATER	A07	PID	unstable temperature control
DXH MAINTAIN	A11	compressor switch-on thresholds	unstable temperature control
SECONDARY HEATER	A12	PID	unstable temperature control
PREHEATER	A16	PID, temp. after heat settings, min/max power	unstable temperature control
MAIN RADIATOR	B03	PID, min/max power	unstable temperature control
DX MAINTAINER	B05	compressor switch-on thresholds	unstable temperature control
VENTILATORS	C16	PID	unstable temp control.
VENTILATORS	C16	setting of efficiency dependence on reg. temp.	matching object properties
RECOVERY DEVICE	D02	PID, min/max power	unstable temperature control with heat recovery
RECOVERY DEVICE	D03	PID	Unstable temperature control with cooling recovery
MIXING CHAMBER	E02	PID in the heating direction	Unstable temp. control with inefficient heat source
MIXING CHAMBER	E03	PID in the cooling direction	Unstable temp. control with inefficient heat source
GENERAL	H01	temp. min/max, temp. min/max setting	matching object properties
VENTILATORS	H02	PID dependence of performance on reg. temp.	unstable performance regulation from temperature
GENERAL	H03	heating/cooling switching thresholds	unstable temperature control
GENERAL	H04	"StdBy" mode parameters	matching object properties
GENERAL	I02	choice of leading temp.	matching object properties
N FANS	C07	PID`	unstable capacity regulation
VENTILATORS W CO2	C08	PID	unstable capacity regulation
VENTILATORS	C12	PID	Unstable regulation of CO2 by changing the output
VENTILATORS	C12	setting of efficiency dependence on CO2 reg.	matching object properties
MIXING CHAMBER	E04	PID	Unstable regulation of CO2 by changing recirculation
MIXING CHAMBER	E06	parameters of the "rapid heating" function	matching object properties
NAVIGATOR	F02	PID	unstable humidity control
COMPOUND HUMIDIFIER	F03	humidifier on/off threshold	unstable or not very precise humidity control
GENERAL	I02	choice of leading v.	matching object properties
HMI BASIC	I05	sensor activation in HMI Basic	matching the needs of the facility
DXH MAINTAIN	A10	compressor run time setting	
DXH INTRODUCTION	A14	compressor run time setting	
DXH INTRODUCTION	A18	compressor run time setting	

CENTRAL	A21	next min. air temp. and shutdown delay.	object sensitive to low supply temp.
---------	-----	---	--------------------------------------

FUNCTION	SCREEN	SCOPE OF CHANGE	NOTES
PREHEATER	A29	Support for heating the supply air	object sensitive to low supply temp.
CENTRAL	A21	next min. air temp. and shutdown delay.	object sensitive to low supply temp.
DX MAINTAINER	B04	compressor run time setting	
VENTILATORS	C11	fire settings	matching object properties
RECOVERY DEVICE	D06	set. share of defrosting methods	Lack of heat source power supply or object sensitive to reduction of supply capacity
NAVIGATOR	G08	humidifier alarm - logic	matching the properties of the humidifier
DIGITAL INPUTS	G07	fire entrance.	matching the characteristics of the fire system.
DIGITAL INPUTS	G07	heating, cooling alarm	matching the properties of the foreign heating/cooling source
DIGITAL OUTPUT	G09	collective alarm logic	matching the needs of the facility
REC. MAIN ELECTR.	A09	setting the power distribution of the heaters	configuration setting
RECORD. ELECTR.	A13	setting the power distribution of the heaters	configuration setting
RECORD. PRE ELECTR.	A17	setting the power distribution of the heaters	configuration setting
DXH	A22	aggregate control signal scaling	matching the characteristics of the cooling source
DXH	A23	set min. temp. ext.	matching the characteristics of the cooling source
VENTILATORS	C05	Set. type. of. vent. and. nominal. capacity.	
VENTILATORS	C06	Pressure setting for VAV controllers	customization of VAV controllers
RECOVERY DEVICE	D03	activation of cooling recovery	
MIXING CHAMBER	E05	min/max working range setting	min - the need for minimum air exchange in the facility, max - installation of intake and exhaust less than N and W
MIXING CHAMBER	E07	set. working method for each profile	matching the needs of the facility
STEAM HUMIDIFIER	F01	ustw. logic of operation, check for correctness	humidifier from outside the VTS offer
DIGITAL INPUTS	G08	Remote AHU profile setup (set profile type and NC/NO logic)	matching the requirements of the facility
DIGITAL INPUTS	G08	input logic. External summer/winter mode override	matching the requirements of the facility
DIGITAL OUTPUT	G09	logic on glycol recovery pump.	matching the control characteristics of the glycol pump
DX, DXH	G10	logic outputs on I and II heating/cooling stage.	matching the characteristics of the cooling source
NAVIGATOR	G11	logic of exit. work permit	matching the properties of the humidifier

FUNCTION	SCREEN	SCOPE OF CHANGE	NOTES
RIBBON HEATER	G11	logic of exit. work permit	matching the properties of the heater
SECONDARY HEATER	G11	logic of exit. work permit	matching the properties of the humidifier
TRANS. VENT. REDUN.	G11	logic of exit. work permit	Matching the properties of control. culvert.
PROCESS. PRESS. FILTERS	G18	activation of transducers	additional air filters
ADDITIONAL FILTERS.	G20	filter type	additional air filters
ADDITIONAL FILTERS.	G21	max. pressure drops.	additional air filters
CONTROLLER	I02	progr./work mode switchover	AHU configuration change, first startup????
VENTILATORS	I03	type of regulation CAV/VAV/none	matching the properties of the ventilation system.
HMI BASIC	I05	allow. alarm reset from HMI Basic	adaptation to user requirements
CONTROLLER	I11	export/import of controller settings	Parameterization of several of the same AHU, archiving of settings
HMI BASIC	J03	activation, address	
FILTERS	J09	type, max. pressure drop	Changing the type of filter, adjusting to the needs of the object
VENTILATORS	J11, J12	set. control. External analog signal	adaptation to the needs of the facility
HMI, PLC	I06	selection of schedule source (Basic/uPC/none)	customization
ACCESS LEVEL.	K01	logout	end of setting change
AHU	Sa01	preview of current AHU utility pairs	
AHU	Sa03 to S07	changes in settings of current parameters	current needs of the facility
HMI	Sa08	setting the date and real time	
HMI	Sa09 to Sa11	setting the work schedule	customization
TEMP.	G05	B1 and B3 calibration	cable length > 5 m

8 MAINTENANCE

8.1 MAINTENANCE



- ! The basic technical data of the air handling unit, such as the type, parameters and dimensions of the most important components (filters, heat exchangers, fans, electric motors), can be found in the technical data sheet, which is supplied with each unit.
- ! All maintenance work on air handling units should be performed with the unit turned off. To ensure safe operation of the unit, the service switch, which cuts off power to the motor during maintenance work, must be installed outside the fan section. Disconnection of the power circuit with the service switch must be done in a de-energized state. The service switch should be located near the inspection panels of the fan section.
- ! It is essential to carry out thorough and regular maintenance work as well as technical inspections of air conditioning units and their components in order to identify faults at an early stage of their occurrence - before more serious failures and damage occur.
- ! This documentation covers only general guidelines for inspection periods to ensure trouble-free operation of air handling units under various possible external conditions for their operation. Technical inspection periods must be adapted to local conditions (level of contamination, number of start-up cycles, loads, etc.).

MULTI-PLANE AIR DAMPERS

If the throttle is dirty and does not work freely, clean it according to one of the following methods:

- Using a vacuum cleaner with a soft suction nozzle,
- By blowing with compressed air,
- Washing with water and non-corrosive cleaning agents for aluminum.

After reinstallation, the damper should be carefully sealed, primarily on the outside air intake side, to prevent the water heater from freezing.

AIR FILTERS

- Under standard operating conditions of air conditioning units, filters should be replaced approximately twice a year. The need to replace the filter (in addition to visually visible contamination) is also demonstrated by a drop in pressure:
 - EU4 - 150Pa,
 - EU5, EU7 - 200 Pa,
 - EU9 - 300 Pa
- If the final pressure difference exceeds the design value, the filter must be replaced. Filters are disposable components.
- When replacing the filter, the filtration section should also be cleaned - with a vacuum cleaner or by dry cleaning.

- When ordering a new filter set from an authorized VTS office, specify the filter type, filtration class, air handling unit size and, if necessary, the filter size, as specified in the technical data sheet or the "AIR FILTERS" section.



- ! The basic technical data of the air handling unit, such as the type, parameters and dimensions of the most important components (filters, heat exchangers, fans, electric motors), can be found in the technical data sheet, which is supplied with each unit.
- ! Incorrectly installed filters, damp or dirty filters can cause an increase in the power consumption of fan motors.
- ! Incorrect, improperly installed filters, soggy or dirty filters can damage the device.
- ! Do not allow the unit to operate with filters that have reached maximum air resistance.

WATER HEATER

- Active water heaters should be equipped with anti-freeze systems. As an option, a non-freezing heating medium (e.g., glycol solution) can be used in winter. If the heating medium supply is cut off or the air handling unit is stationary, and if the air temperature is likely to fall below + 5°C, the heater should be drained. To do this, it is necessary to:
 - close the heating medium inlet and outlet valves (cut off the heater from the heating system),
 - Remove the inspection panel,
 - Unscrew the drain and remove the vent plug from the collectors,
 - connect the output hose to the drain, allowing water to run off the evacuated exchanger outside the unit,
 - Blow out the heater with compressed air, introduced through the vent plug,
 - repeat this procedure several times in short intervals until the air coming out of the drain hose shows no visible water droplets,
 - Screw the drain plug and vent plug back in.
- Check the level of dirt on the heater plates at least once every four months. The settlement of dust on the surface of the heater causes a deterioration of its heating power and leads to a decrease in air-side pressure. Even if the air handling unit is equipped with filters over time dust, supplied with the supplied air, settles on the heater plates. If the plates become dirty, their cleaning should be carried out in one of the following ways:
 - Using a vacuum cleaner with a soft suction nozzle on the air inlet side,
 - by blowing with a jet of compressed air against the direction of normal air flow, directing the jet parallel to the plates,
 - Washing with warm water with non-corrosive cleaning agents for aluminum or copper components.
- Before washing, protect adjacent sections of the air conditioning unit from contamination.
- To achieve maximum heating capacity of the heater, it must be well vented. For this purpose, vent plugs have been designed, located on the heater manifolds.
- When the air handling unit is stationary, the flow of the heating medium should be limited to a minimum, so that the temperature inside the air handling unit does not exceed the value of +60°C.

Exceeding this value could cause damage to some components or subassemblies (motor, bearings, plastic elements, etc.), installed in adjacent sections.

WATER HEATER REPLACEMENT - HEX SECTION

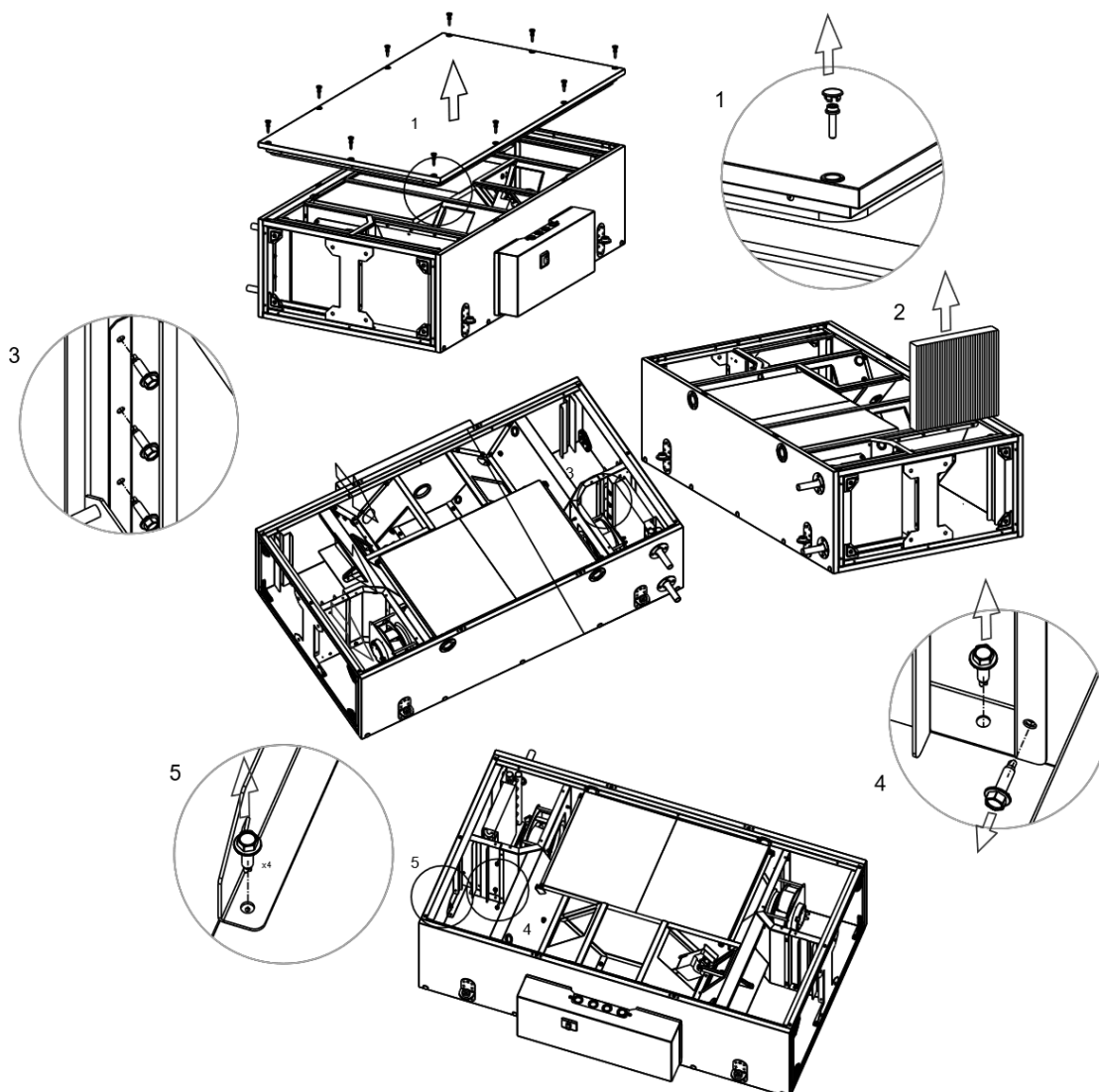

WATER HEATER REPLACEMENT - HEX SECTION

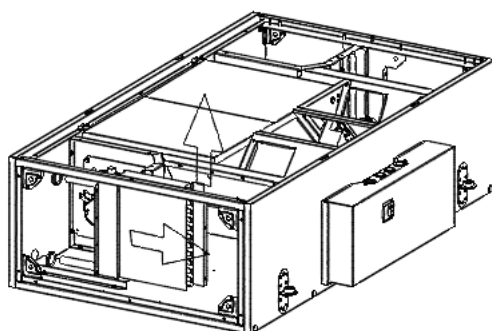
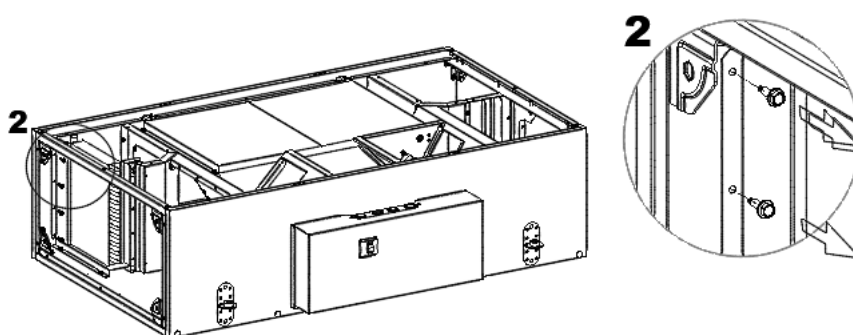
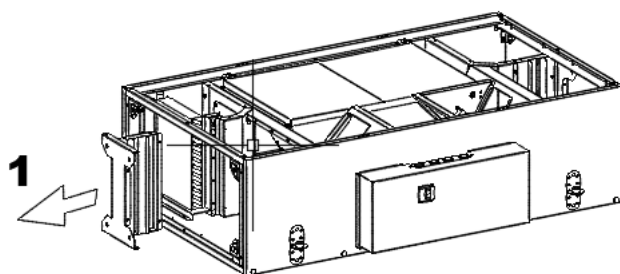

ELECTRIC HEATER

- The electric heater battery consists of bare heating coils. During operation of the air conditioning unit, when the heater is turned off, dust may settle on the heating coils. When the heater is restarted, heavy contamination of its surface can generate unpleasant odors of burning dust, even leading to an initial fire hazard.
- Check regularly, (every 4 months), and especially before the start of the heating season, all electrical connections, the condition of the heating elements and their level of contamination. Any dirt should be removed with a vacuum cleaner with a soft tip or compressed air.
- The operation of the overheating protection system in the absence of air flow should also be checked. The speed of air flow should not be less than 1.5 m/s.

WATER COOLER

- The level of dirt in the radiator should be checked, every four months. If necessary, the radiator should be cleaned with water heater cleaning methods.
- Before washing, protect adjacent sections of the air conditioning unit from contamination.
- When checking the level of contamination, the functionality of the condenser should also be checked, as well as the capacity of the water trap. The water trap should be filled with water before starting the air conditioning unit.
- If the condenser is dirty, wash it out with warm water and detergent.
- In order to get maximum performance from the radiator, it must be well vented. For this purpose, vent plugs have been designed, located on the radiator manifolds.

FREON HEATERS AND COOLERS

- Maintenance of the freon cooler includes the same range of activities as maintenance of the heater and water cooler. Before washing the freon cooler with warm water, the cooling system should be emptied by draining the freon into a container. Otherwise, there will be a risk of uncontrolled increase in freon pressure, causing damage to the cooling system.

COUNTERCURRENT HEAT EXCHANGER

- This exchanger should be inspected, every four months, and the inspection should cover the technical condition as well as the level of impurities. The accumulation of dirt on plate heat exchangers is often limited to the first 50 mm in the exchanger. Before cleaning, adjacent sections of the air conditioning unit should be protected from contamination.
- The necessary cleaning should be carried out as follows:
 - Using vacuum cleaners with a soft suction nozzle,
 - By blowing the ducts with a stream of air in the direction opposite to the direction of normal air flow,
 - Washing the air ducts along the entire length with water with cleaning agents that do not cause corrosion of aluminum,
 - In the case of very dirty exchangers, a stream of pressurized water can be used to clean them.
- When cleaning the exchanger with mechanical means, pay maximum attention not to damage or deform the exchanger panels.
- When operating the exchanger in sub-zero temperatures, it must be thoroughly dried after washing before restarting.
- Gaining access to the counterflow heat exchanger in the VVS005s-030s air handling unit requires removing the drain gutter from the unit. To do this, disconnect the drain gutter from the drain system, remove the plastic extension tubes and remove the self-tapping screws securing the gutter, as shown in the figure below.

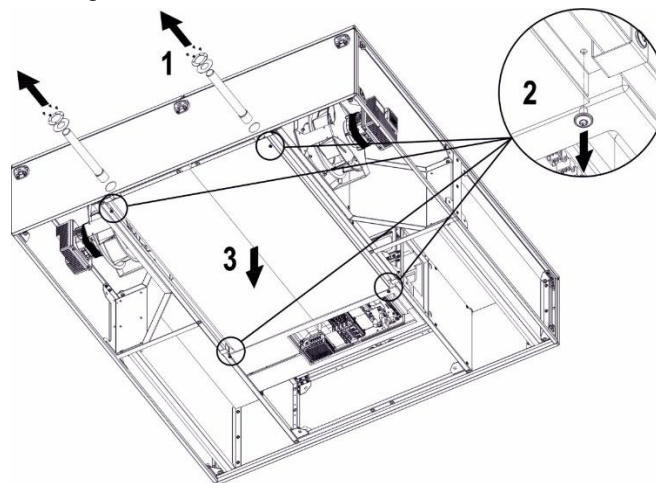

SOUND ATTENUATORS (DAMPING SPHERES)

The muffler section is equipped with baffles made of non-combustible mineral wool that absorbs acoustic energy. Maintenance procedures include checking the level of contamination of these baffles and removing the contamination without damaging the surface.

FAN UNIT

- Before performing any work (repair, maintenance, service) on the air handling unit, especially when opening inspection panels in the fan section, as well as when removing covers over the drive system, make sure that:

- The device has been properly disconnected from the power supply. This applies to both primary and secondary circuits,
 - The rotor does not rotate,
 - The fan surfaces are cool and temperature-safe to the touch,
 - The fan is protected against unintentional startup.
- The fans are designed for dust-free or lightly dusty air flow. They are not designed to operate with aggressive gases, vapors or in highly dusty environments. Operating fans in unsuitable environments can lead to bearing damage, corrosion, rotor imbalance or vibration.
- The fan and motor of the unit are provided to meet special requirements and for special operating characteristics. The fan speed is set so that the airflow and total impeller stress concentration are appropriate for the ventilation system. A lower forced air flow rate causes operating disturbances and leads to a loss of balance of the entire ventilation system.
- This can be caused by:
 - Dust deposition on the fan impeller blades,
 - Wrong direction of fan rotation. If the radial fan rotates in the wrong direction, the air flow causes significantly harmful effects.
- When performing maintenance on a fan, check that:
 - the rotor rotates freely, - the rotor is properly balanced,
 - The rotor is securely fastened to the journal,
 - has not changed position relative to the inlet cone,
 - all screws securing the structural components of the fan are tightened.
 - Rotor imbalance can be caused by:
 - Dust deposition on the rotor blades,
 - detachment of additional balancing weights,
 - rotor blade damage.
- Checking the level of contamination of the interior of the housing, rotor and motor should be carried out, every four months.
- Cleaning should be done by vacuuming or wiping all surfaces with a wet cloth. For more serious dirt, nylon brushes can be used:
 - The inside of the housing with a vacuum cleaner,
 - Rotor with a vacuum cleaner or by damp wiping with a cloth dampened in a soft cleaner.

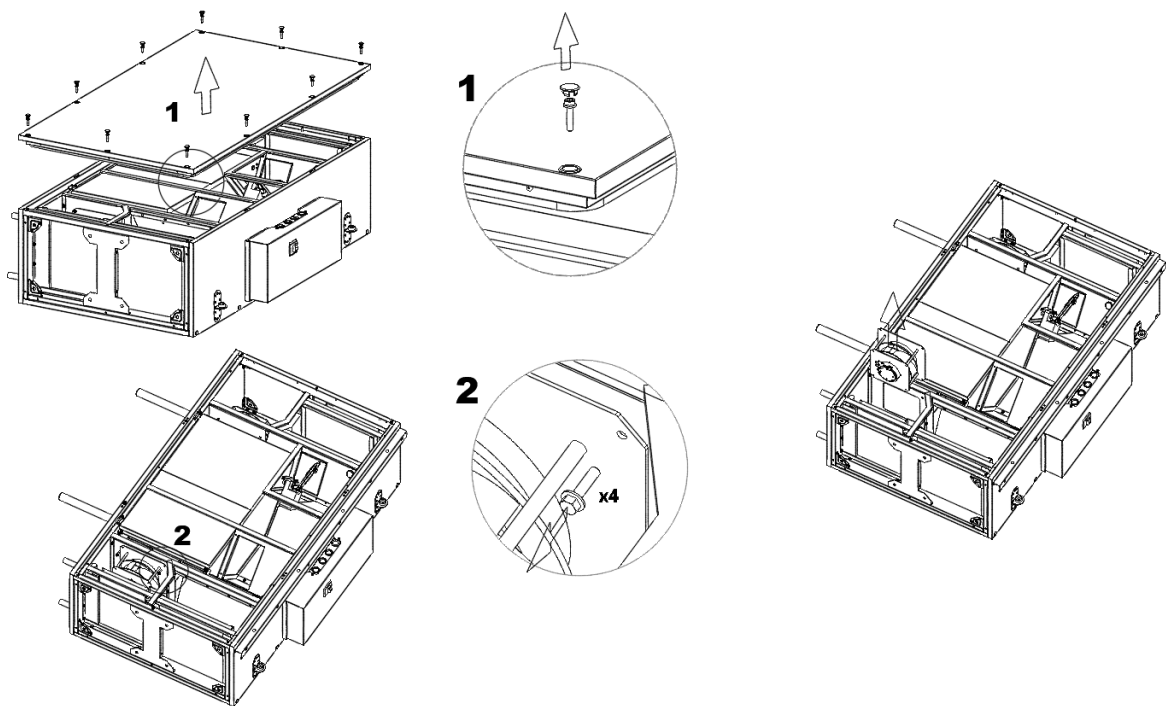

FAN REPLACEMENT



8.2 CONSUMABLES – AIR FILTERS



SKANUJ I KUP
ZESKANUJ KOD QR NA SWOJEJ CENTRALI LUB
ZNAJDZ ZESTAW FILTRÓW PO NUMERZE URZĄDZENIA

KUP ZESTAW FILTRÓW
ONLINE
www.eshop.vtsgroup.com

! Replacement parts are available from the manufacturer's online store and from the network of authorized service centers at www.eshop.vtsgroup.com.

8.2.1 AIR FILTERS

DESCRIPTION	CLASS	WXHXL	VVS 005s	VVS 010s	VVS 015s	VVS 020s	VVS 030s	
MiniPleat	ePM10 40% (EU5)	713x320x48			1			
		513x320x48		1				
		332x320x48	1					
		1017x410x48					1	
			742x410x48			1		
	ePM2.5 65% (EU7)	713x320x48				1		
		513x320x48			1			
		332x320x48	1					
		1017x410x48						1
			742x410x48			1		
	ePM1 80% (EU9)	713x320x48				1		
		513x320x48			1			
332x320x48		1						
1017x410x48							1	
		742x410x48			1			
Pocket (bagged) (300mm)	ePM10 40% (EU5)	332x320x300	1					
		513x320x300		1				
		713x320x300			1			
		742x408x300				1		
			1017x408x300				1	
	ePM2.5 65% (EU7)	332x320x300	1					
		513x320x300			1			
		713x320x300				1		
		742x408x300				1		
			1017x408x300				1	
Pocket (bagged) (600mm)	ePM2.5 65% (EU7)	332x320x600	1					
		513x320x600		1				
		713x320x600			1			
		742x408x600				1		
			1017x408x600				1	
	ePM1 80% (EU9)	332x320x600	1					
		513x320x600			1			
		713x320x600				1		
		742x408x600				1		
			1017x408x600				1	

8.3 OTHER SPARE PARTS

8.3.1 WATER EXCHANGERS

DIMENSIONS OF WATER EXCHANGERS											
Model	LL	LD	HR	B	C	F	G	FROM		Weight	Capacity
	[mm]							[mm]	[in.]	[kg]	dm ³
VVS005s WCL1	203	333	300	75	32	54	15	22	3/4"	1,6	0,3
VVS005s WCL2	203	333	300	96	32	54	15	22	3/4"	2	0,5
VVS005s WCL3	203	333	300	118	431	54	15	22	3/4"	2,3	0,6
VVS005s WCL4	203	333	300	140	65	54	15	22	3/4"	2,9	0,8
VVS005s WCL6	203	333	300	183	108	54	15	22	3/4"	3,7	1
VVS010s WCL1	403	513	300	75	32	54	15	22	3/4"	2,3	0,4
VVS010s WCL2	403	513	300	96	32	54	15	22	3/4"	2,9	0,7
VVS010s WCL3	403	513	300	118	43	54	15	22	3/4"	3,5	1
VVS010s WCL4	403	513	300	140	65	54	15	22	3/4"	4,4	1,2
VVS010s WCL6	403	513	300	183	108	54	15	22	3/4"	5,9	1,7
VVS015s WCL1	603	713	300	75	32	54	15	22	3/4"	3	0,6
VVS015s WCL2	603	713	300	96	32	54	15	22	3/4"	3,9	0,9
VVS015s WCL3	603	713	300	118	43	54	15	22	3/4"	4,8	1,3
VVS015s WCL4	603	713	300	140	65	54	15	22	3/4"	6,2	1,7
VVS015s WCL6	603	713	300	183	108	54	15	22	3/4"	8,5	2,4
VVS020s WCL1	603	743	375	75	32	54	15	22	3/4"	3,4	0,7
VVS020s WCL2	603	743	375	96	32	54	15	22	3/4"	4,5	1,2
VVS020s WCL3	603	743	375	118	43	57	18	28	1"	5,9	1,6
VVS020s WCL4	603	743	375	140	65	57	18	28	1"	7,5	2,3
VVS020s WCL6	603	743	375	183	108	57	18	28	1"	10,2	3,2
VVS030s WCL1	900	1018	375	75	32	54	15	22	3/4"	4,6	0,9
VVS030s WCL2	900	1018	375	96	32	57	18	28	1"	6,3	1,8
VVS030s WCL3	900	1018	375	118	43	57	18	28	1"	8,1	2,4
VVS030s WCL4	900	1018	375	140	65	57	18	28	1"	10,4	3,1
VVS030s WCL6	900	1018	375	183	108	58	19	28	1"	14,4	4,5

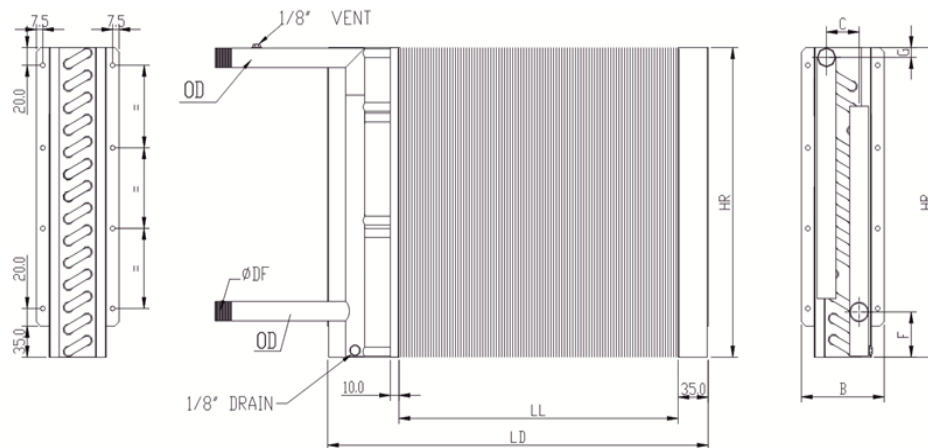

8.3.1 DX EXCHANGERS

DIMENSIONS OF EXCHANGERS DX											
Model	LL	LD	HR	B	C	F	G	FROM in	OD out	Weight	Capacity
	[mm]							[mm]		[kg]	dm ³
VVS005s DX 2-1	203	333	300	96	32	19	80	16	28	1,7	0,4
VVS005s DX 3-1	203	333	300	118	43	19	80	16	28	2,0	0,6
VVS005s DX 4-1	203	333	300	140	65	19	80	16	28	2,5	0,7
VVS005s DX 6-1	203	333	300	183	108	19	80	16	28	3,3	1,0
VVS010s DX 2-1	403	513	300	96	32	19	80	16	28	2,6	0,7
VVS010s DX 3-1	403	513	300	118	43	19	80	16	28	3,2	0,9
VVS010s DX 4-1	403	513	300	140	65	19	80	16	28	4,1	1,2
VVS010s DX 6-1	403	513	300	183	108	19	80	16	28	5,7	1,7
VVS015s DX 2-1	603	713	300	96	32	19	80	16	28	3,6	0,9
VVS015s DX 3-1	603	713	300	118	43	19	80	16	28	4,6	1,3
VVS015s DX 4-1	603	713	300	140	65	19	80	16	28	5,9	1,6
VVS015s DX 6-1	603	713	300	183	108	19	80	16	28	8,2	2,4
VVS020s DX 2-1	603	743	375	96	32	19	80	16	28	4,2	1,1
VVS020s DX 3-1	603	743	375	118	43	19	80	16	28	5,3	1,6
VVS020s DX 4-1	603	743	375	140	65	19	80	16	28	6,9	2,1
VVS020s DX 6-1	603	743	375	183	108	19	80	16	28	9,7	3,0
VVS030s DX 2-1	900	1018	375	96	32	19	80	16	28	5,8	1,6
VVS030s DX 3-1	900	1018	375	118	43	19	80	16	28	7,5	2,2
VVS030s DX 4-1	900	1018	375	140	65	19	80	16	28	9,8	2,9
VVS030s DX 6-1	900	1018	375	183	108	19	80	16	28	13,9	4,3
VVS030s DX 6-2	900	1018	375	183	108	19	80	16	28	17,1	4,3

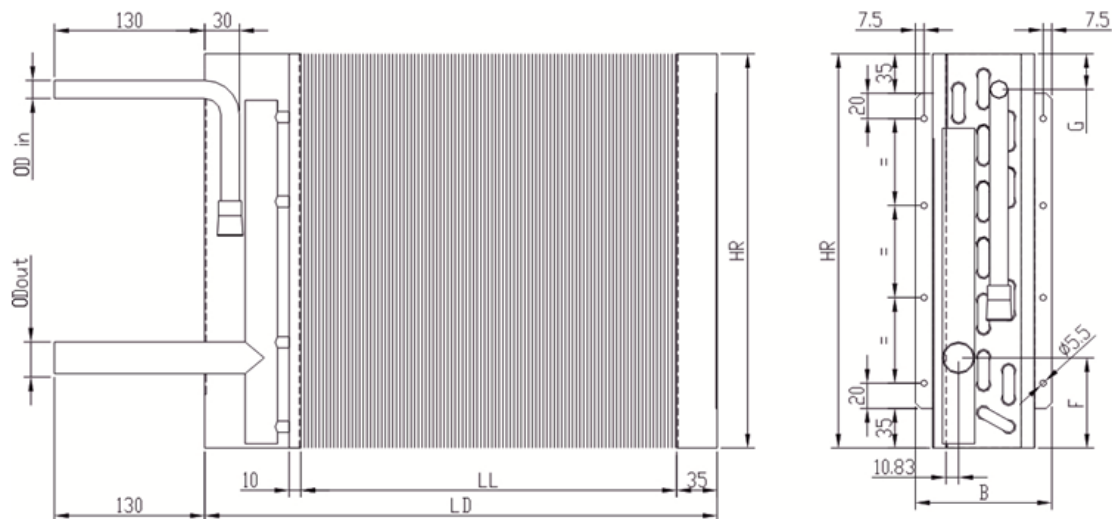

9 WIRING DIAGRAMS

9.1 DUCTED ELECTRIC HEATER WIRING DIAGRAMS

9.1.1 HEATER - LOW POWER - 2.5KW - VVS005 s

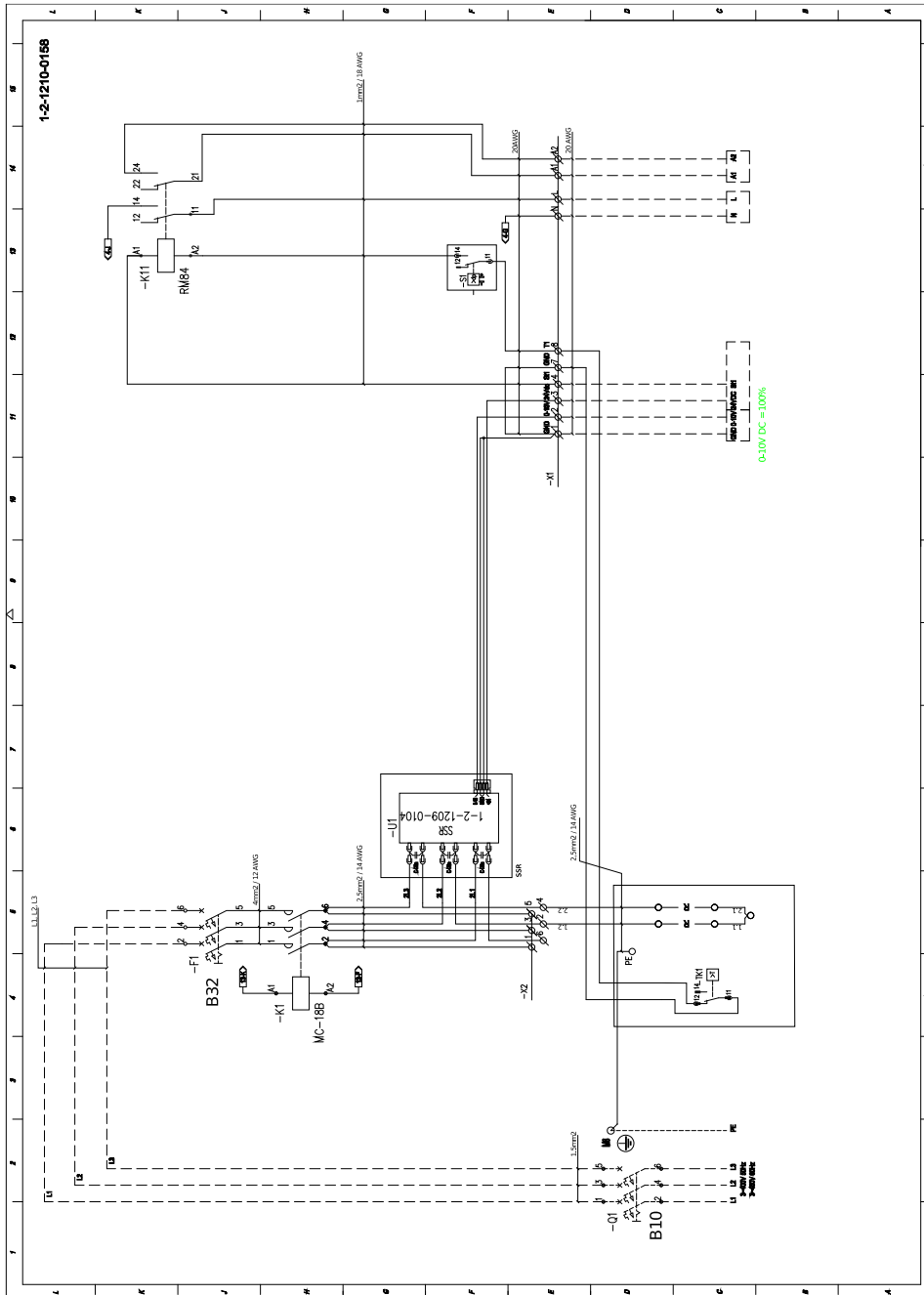

9.1.2 HEATER - LOW POWER - 3KW - VVS010 s

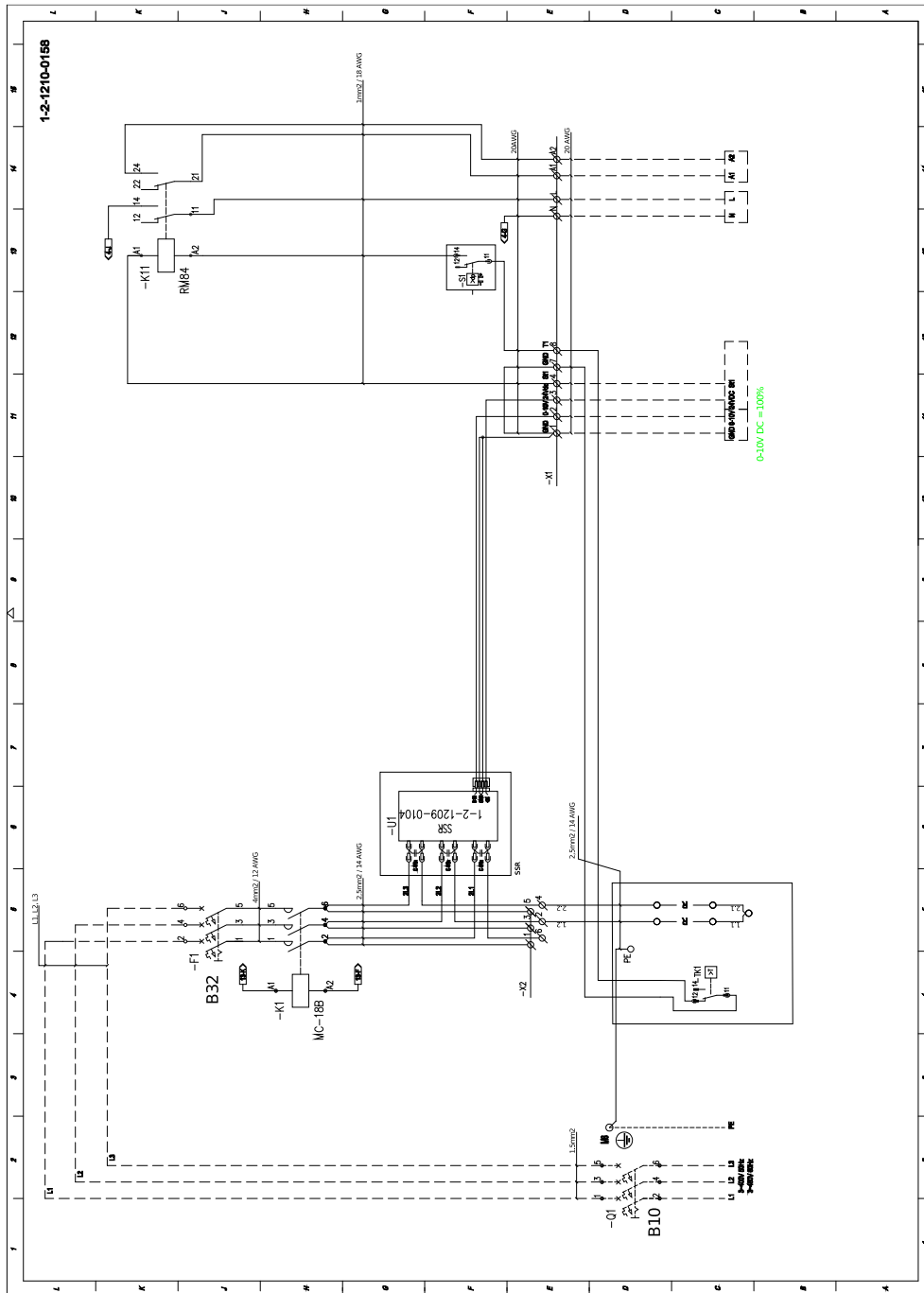

9.1.3 HEATER - LOW POWER - 6KW - VVS015s - VVS030 s

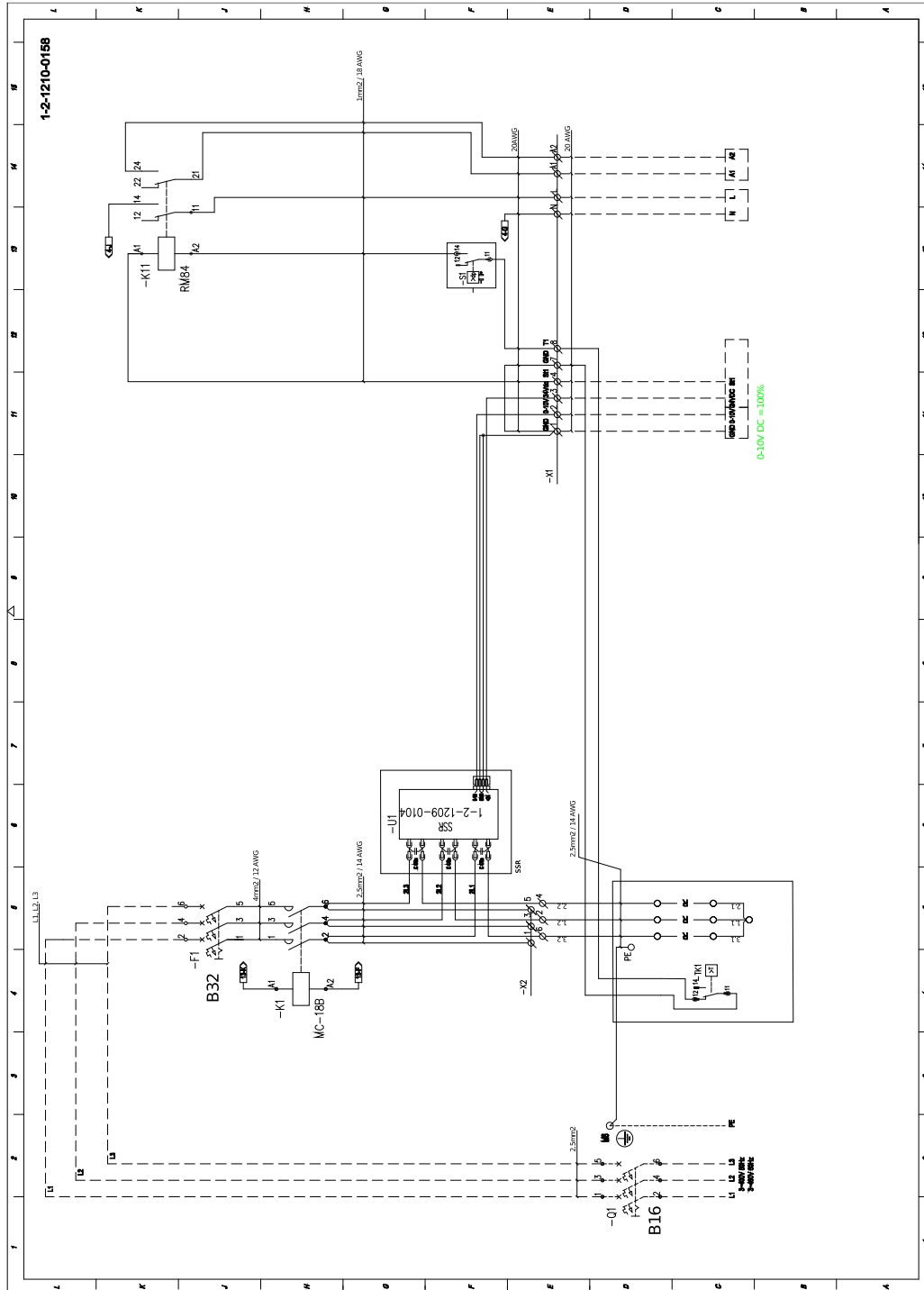

9.1.4 HEATER - HIGH POWER - 10KW - VVS005 s

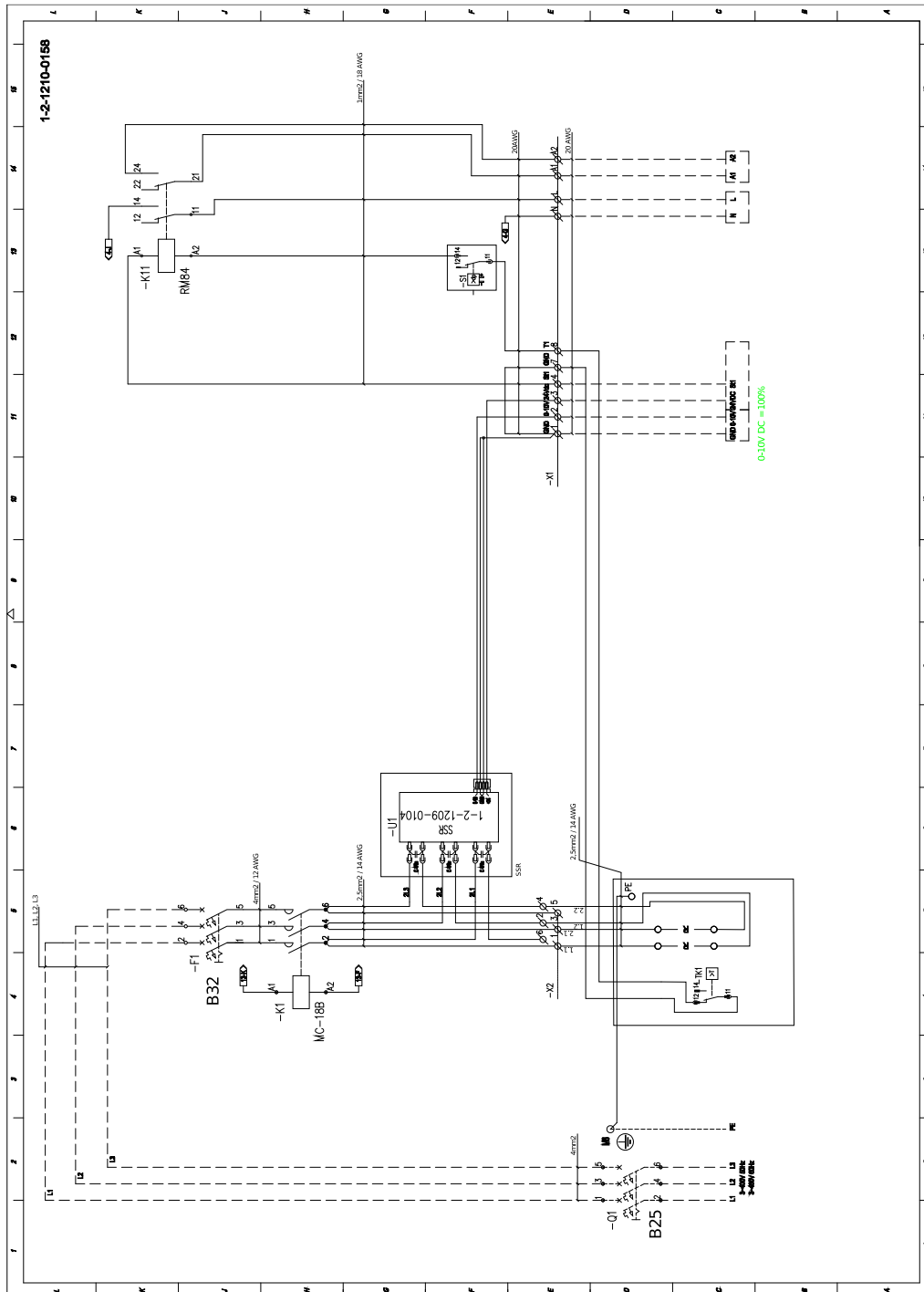

9.1.5 HEATER - HIGH POWER - 12KW - VVS010 s

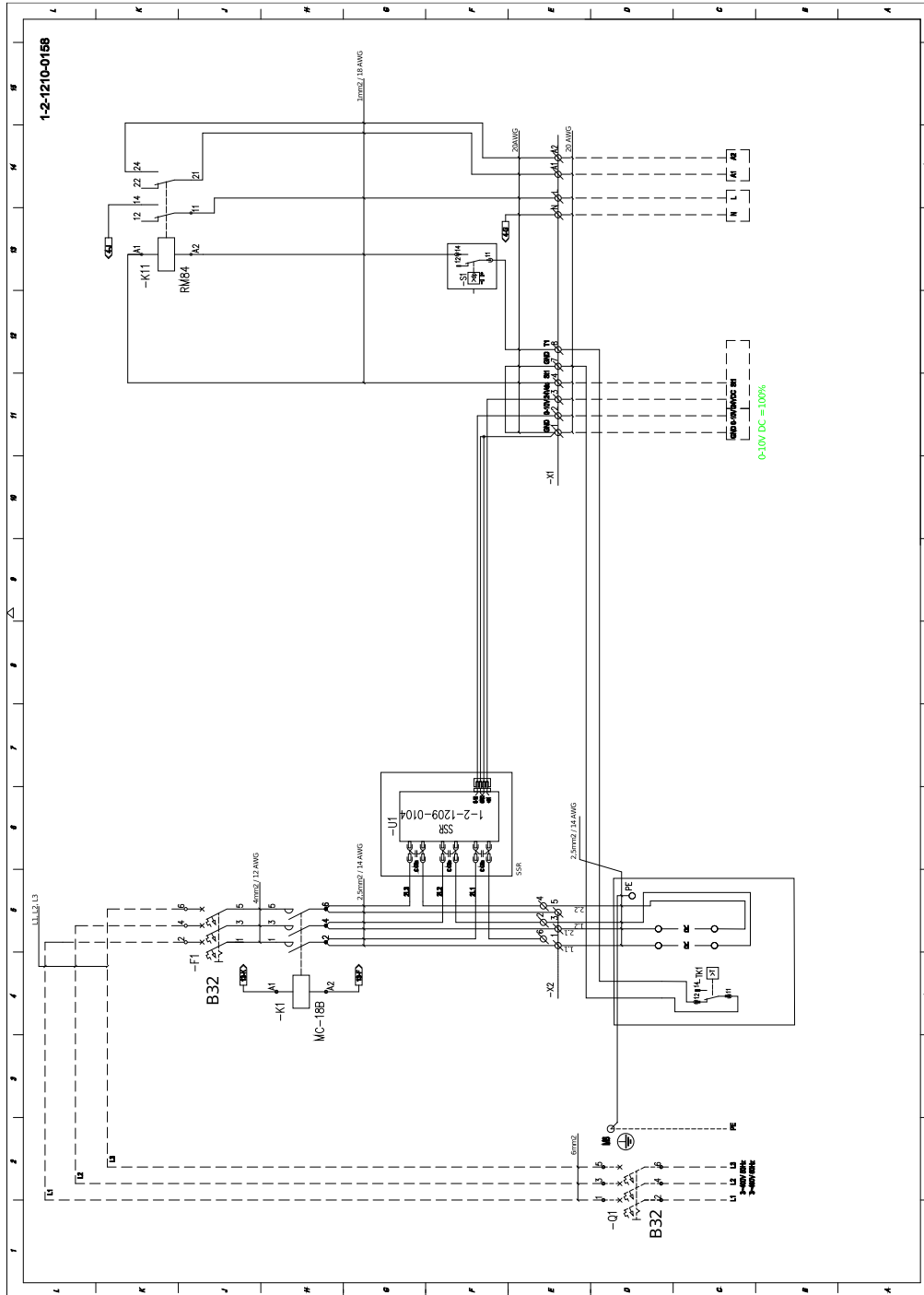

9.1.6 HEATER - HIGH POWER - 18KW - VVS015s - VVS030 s

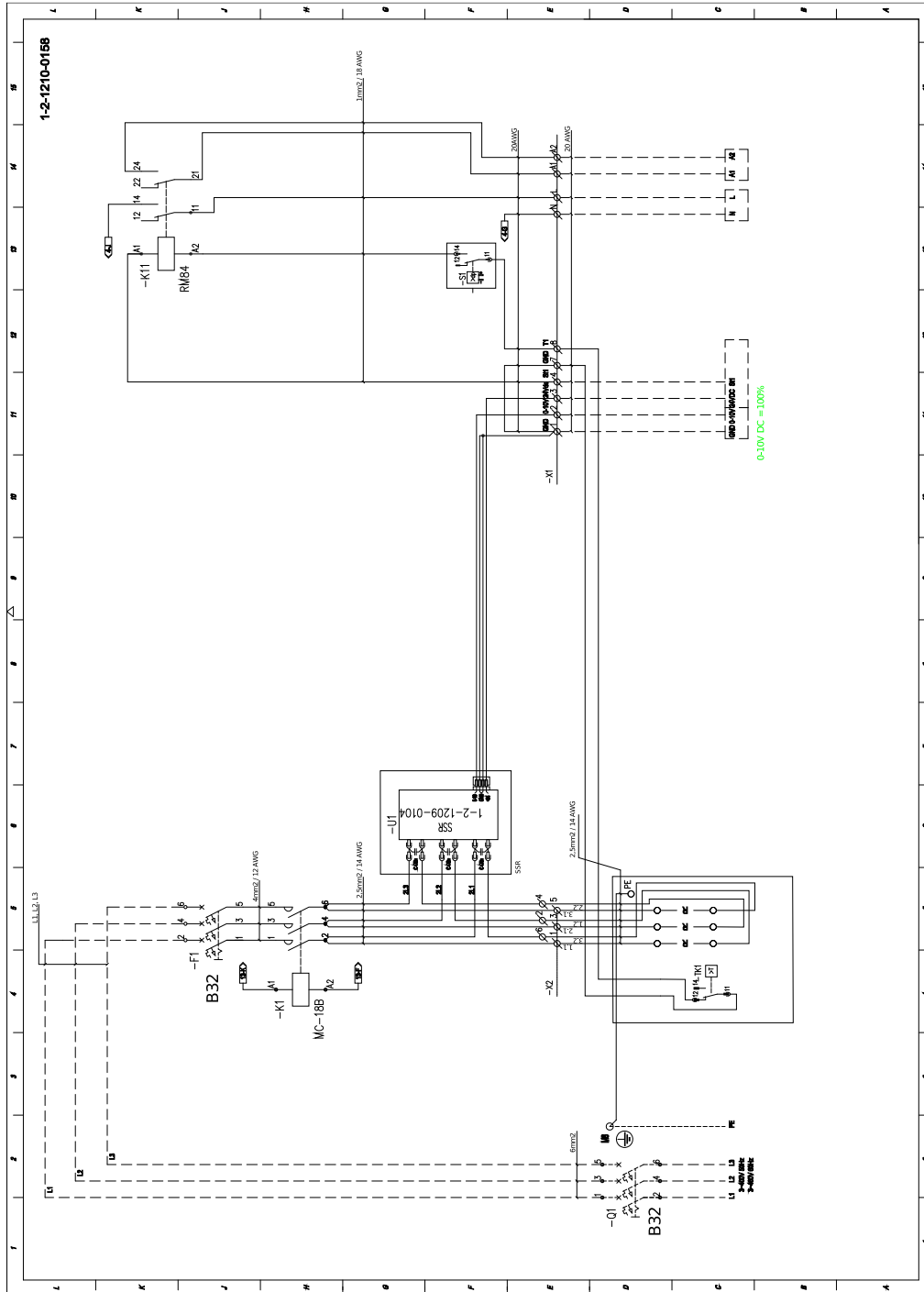

9.1.7 HEATER - HIGH POWER - 36KW - VVS015s - VVS030 s

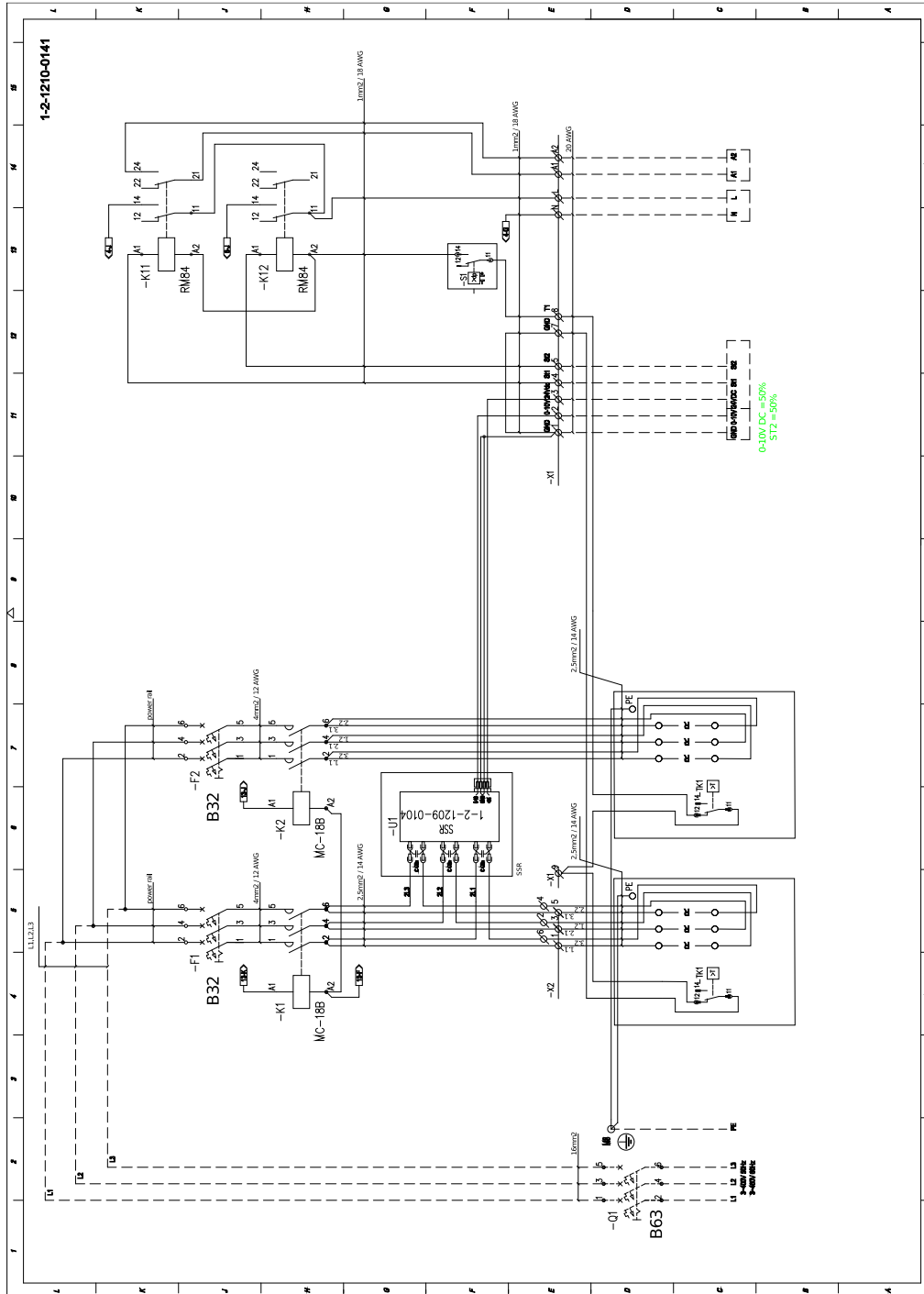

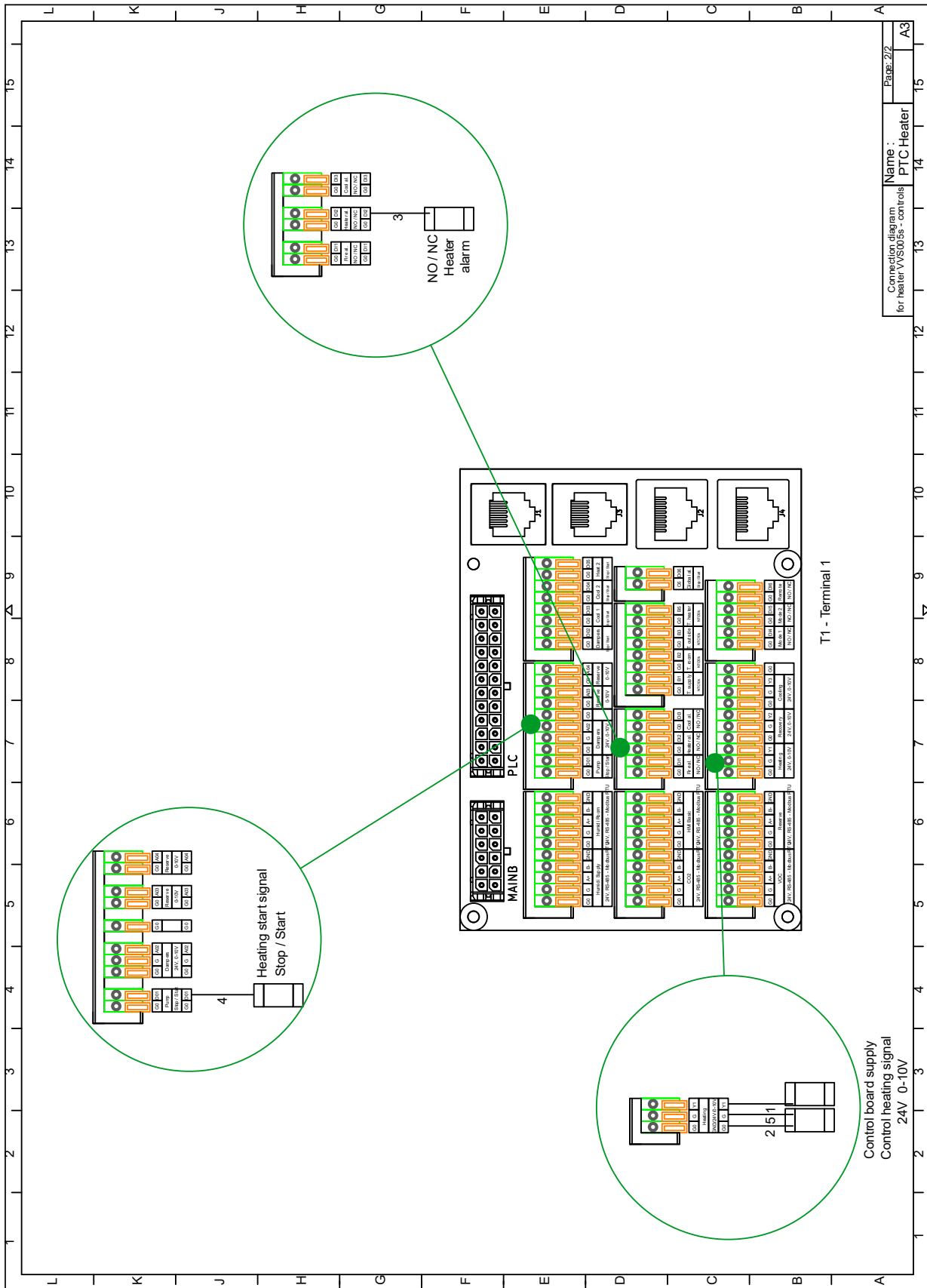

Page: 2/2
 Name: PTC Heater
 Connection diagram for heater VVS05s - controls

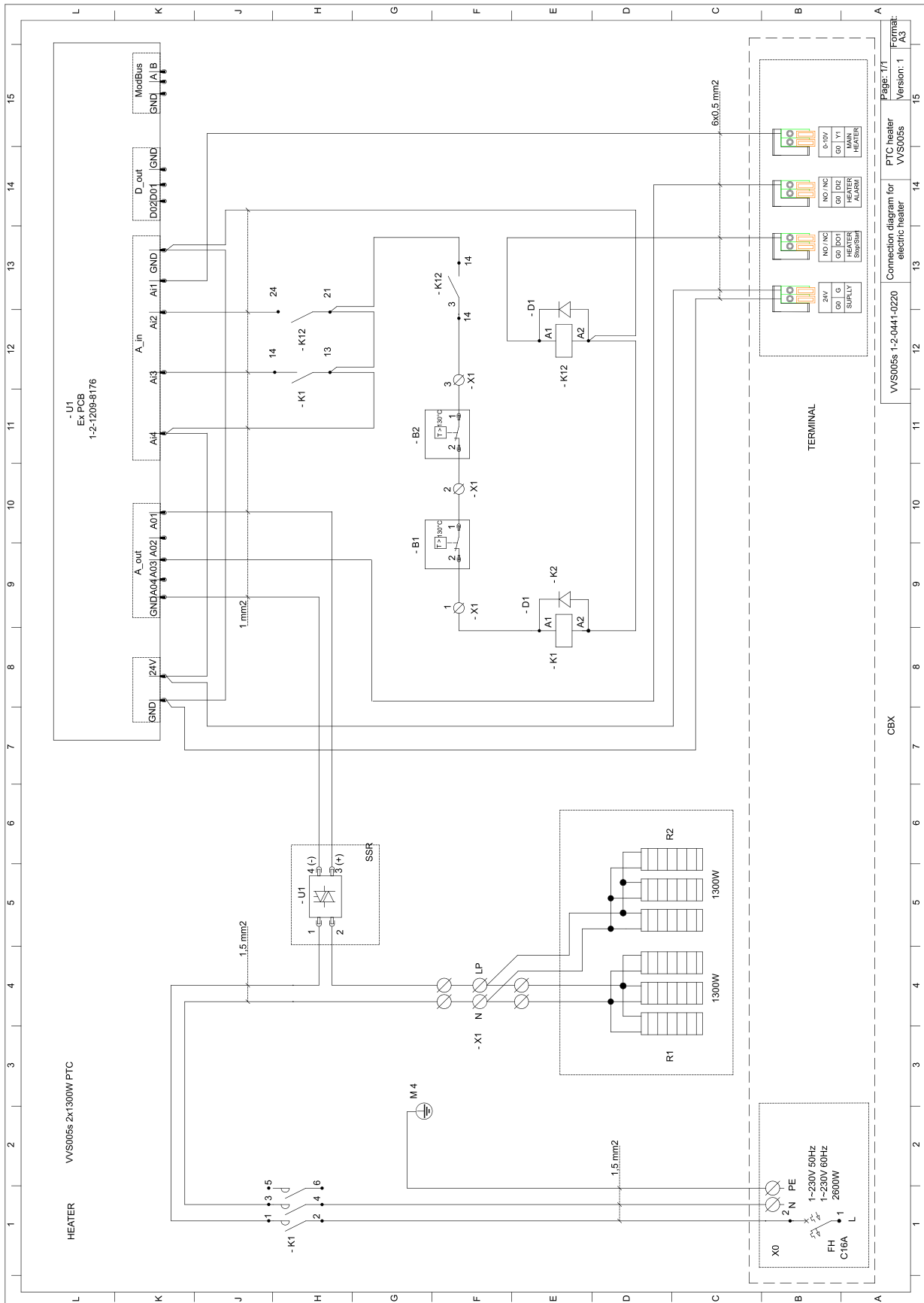

9.3 DEVICE CONNECTION DIAGRAM

9.3.1 PLUG&PLAY UNITS WITH HEX (1/6)

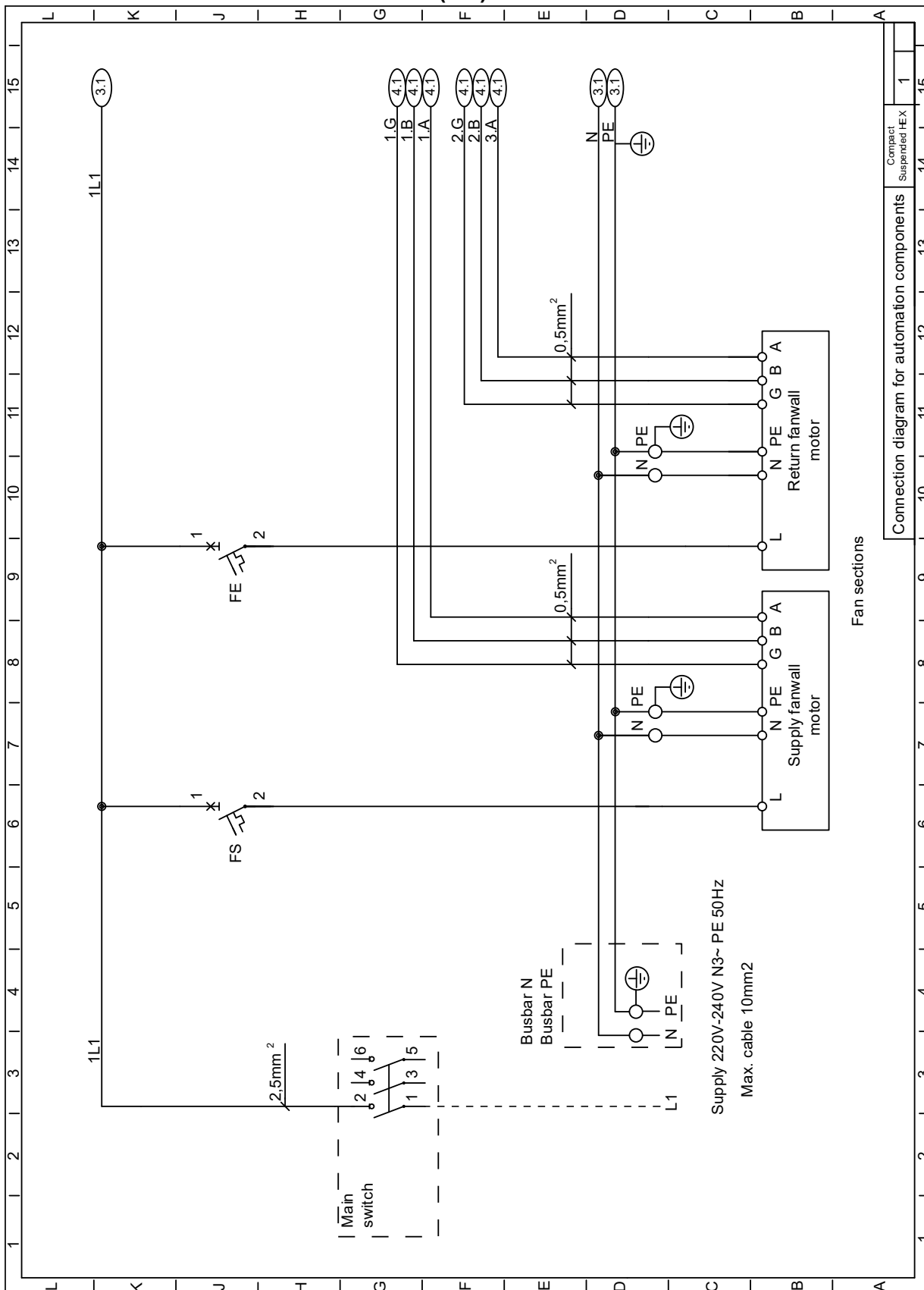

9.3.2 PLUG&PLAY UNITS WITH HE (2/6)

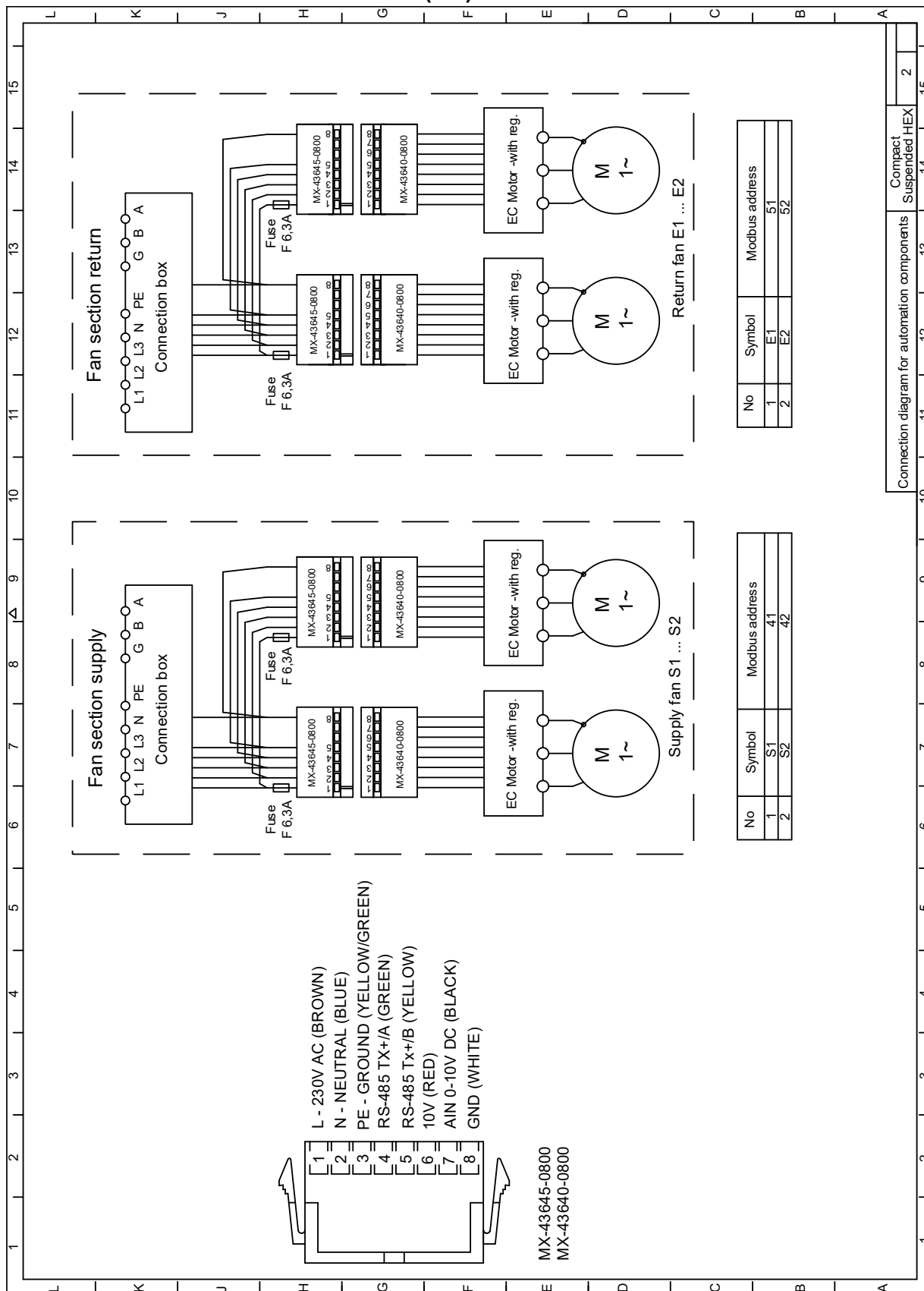

9.3.3 PLUG&PLAY UNITS WITH HEX (3/6)

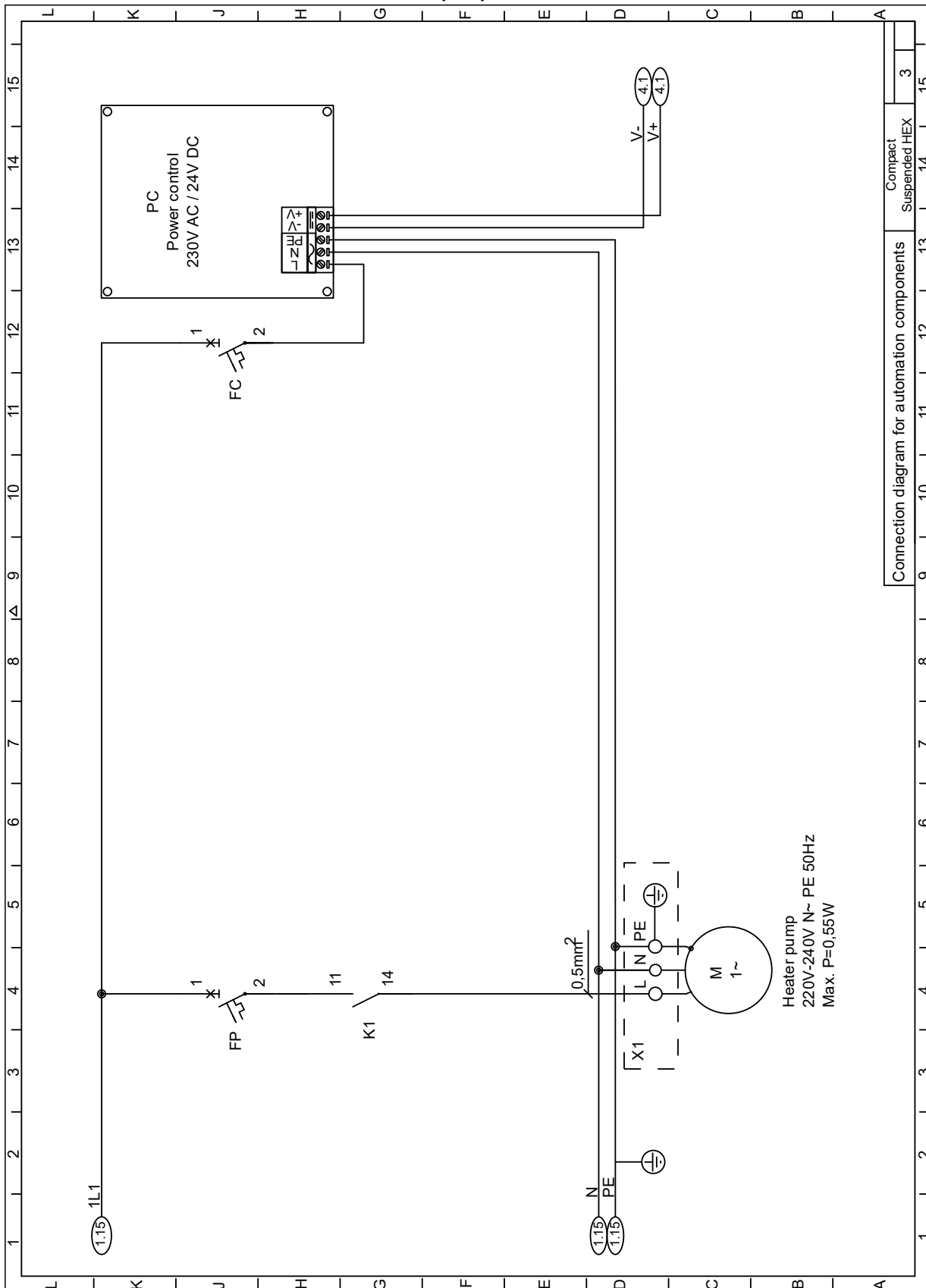

9.3.4 PLUG&PLAY UNITS WITH HEX (4/6)

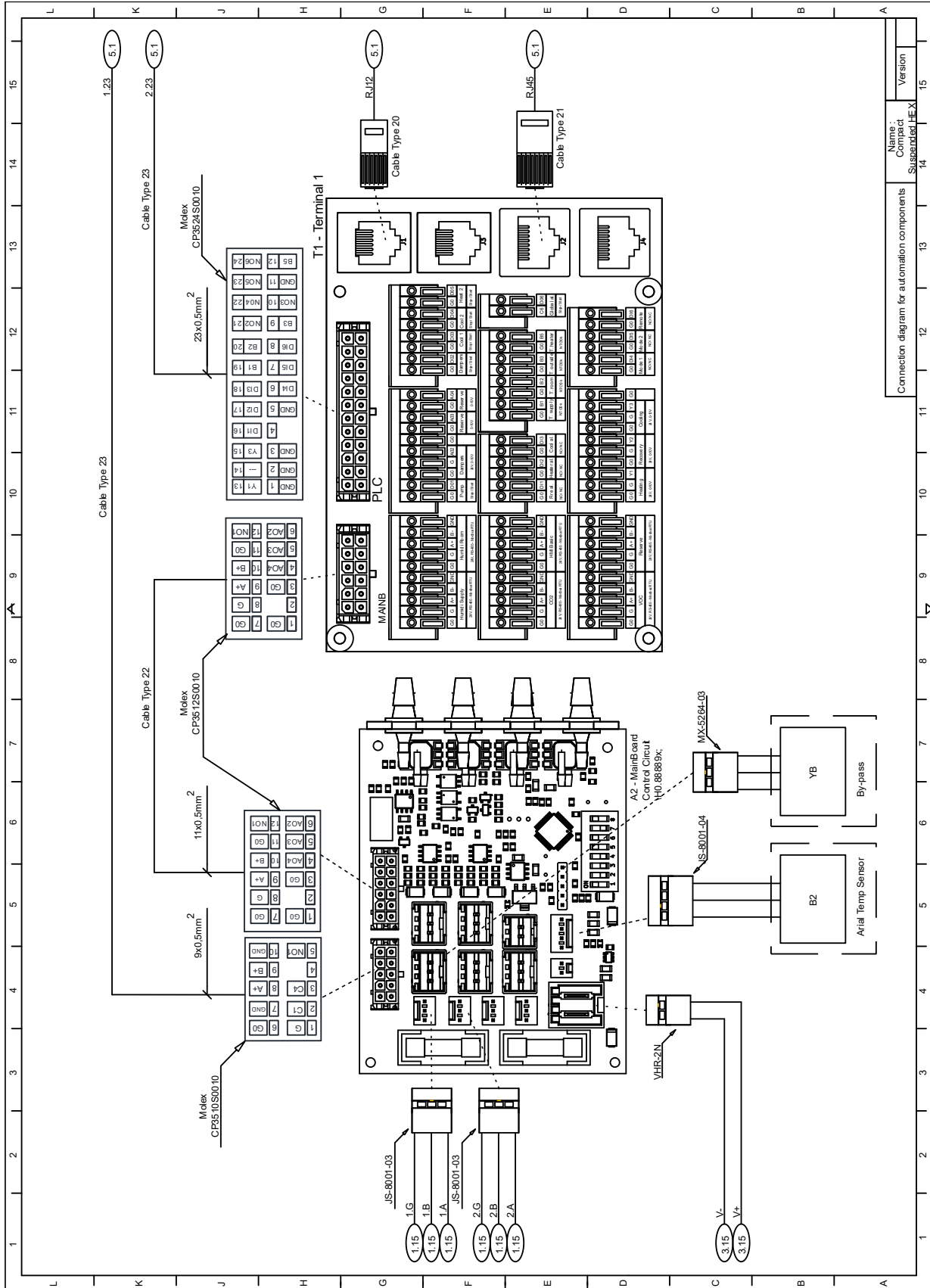

Name:	Version
Compact	15
Suspended HEX	14

9.3.5 PLUG&PLAY UNITS WITH HEX (5/6)

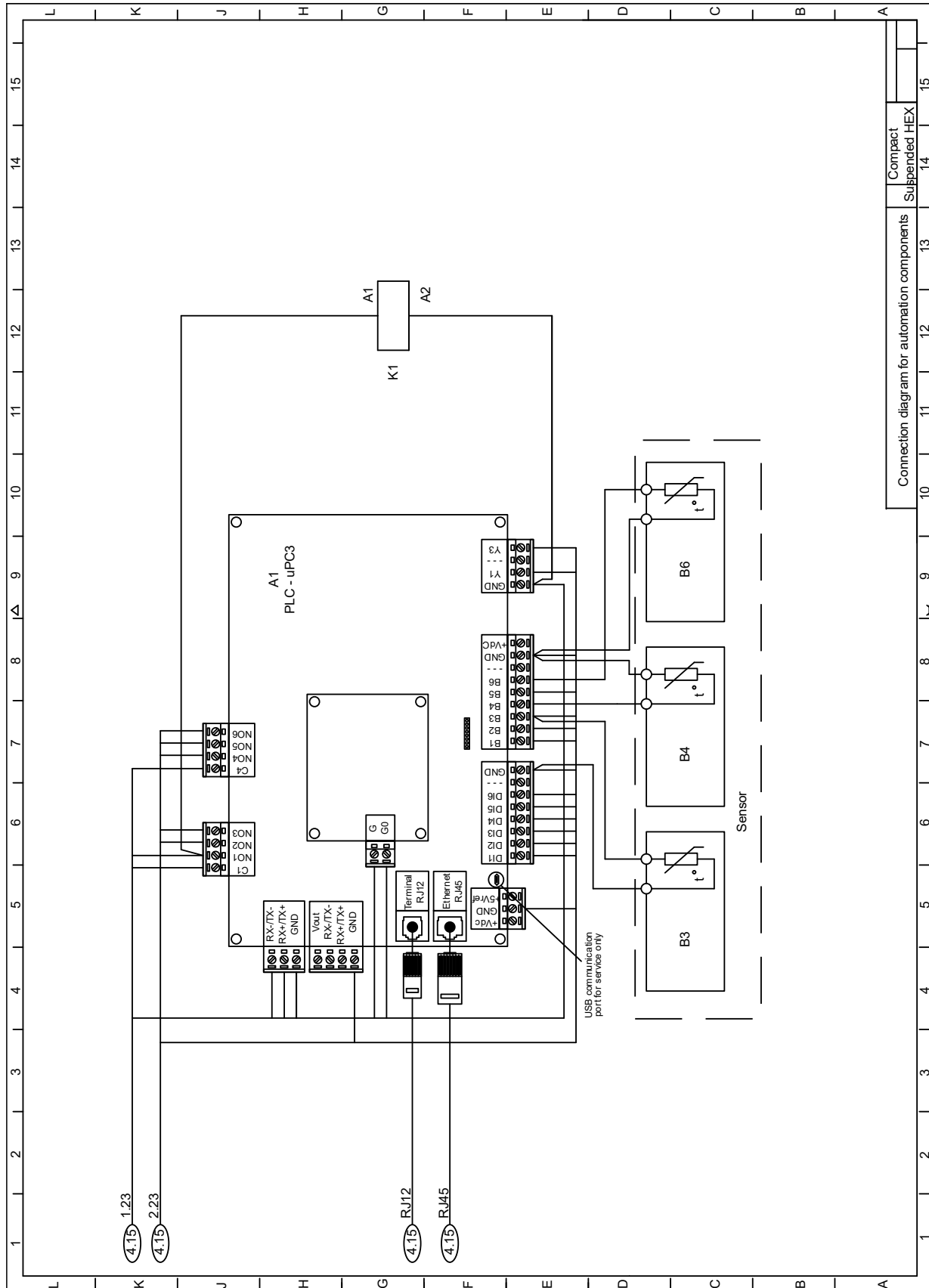

9.3.6 PLUG&PLAY UNITS WITH HEX (6/6)

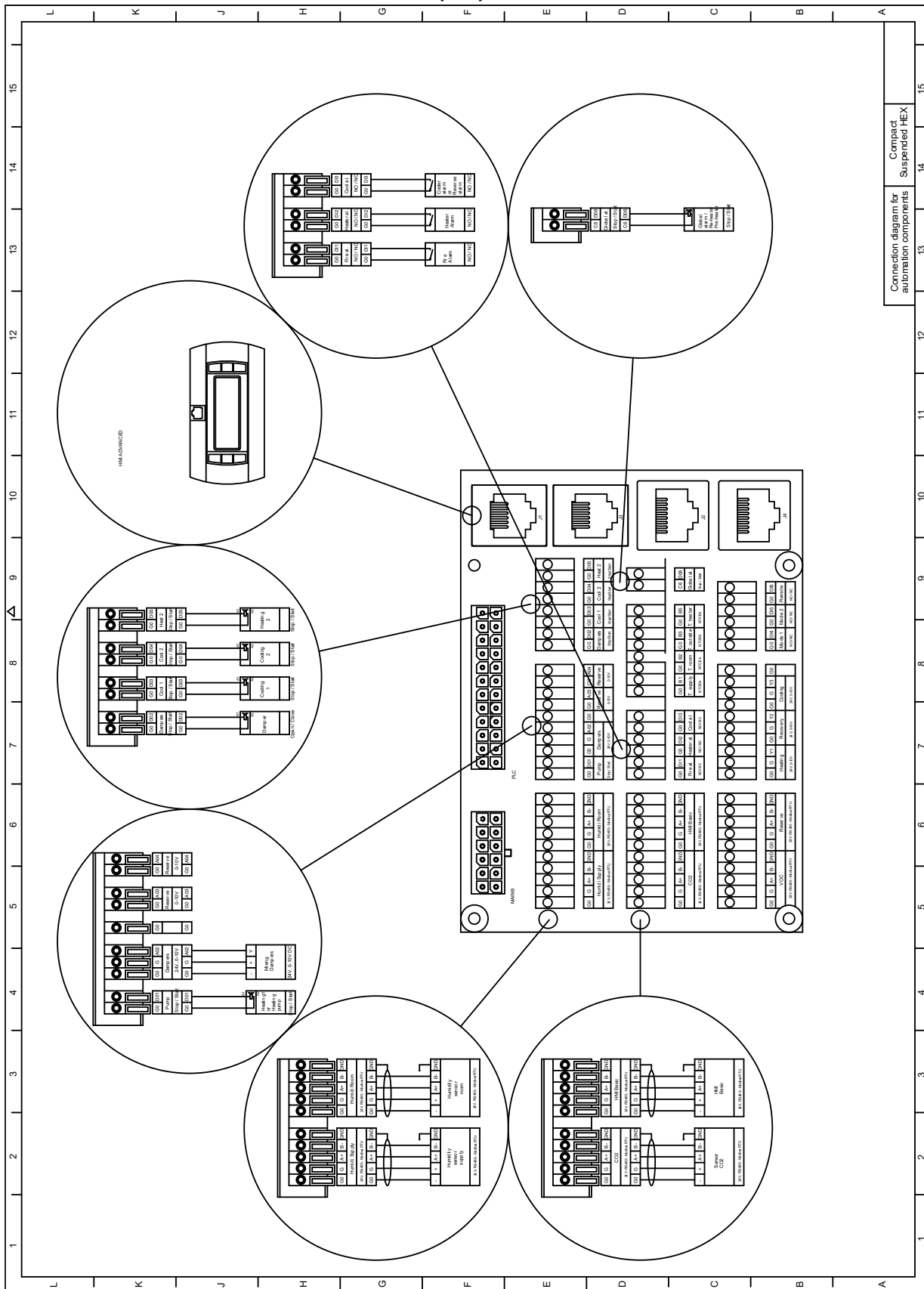

9.4 HEALTH AND SAFETY INSTRUCTIONS



- ! Connection and commissioning of the air conditioning unit should be carried out by qualified personnel and in accordance with the recommended regulations and guidelines, relating to the operation of electrical equipment.
- ! Under no circumstances should the device be connected to a power source before activating the protection system.
- ! Under no circumstances should repairs or maintenance work be carried out if the device remains connected to the power supply.
- ! Operation of the air conditioning unit with the inspection panel removed is strictly prohibited.
- ! Service, repair or maintenance personnel designated for air handling units must be qualified and authorized to perform all required activities in accordance with the regulations that apply in the country where the unit is installed.
- ! The installation location of the control panel must have the necessary safety equipment and fire-fighting equipment/devices, in accordance with local regulations.



- ! Routine inspections, carried out by qualified technical personnel or service personnel authorized by VTS, guarantee long-term, reliable and trouble-free operation of the equipment. Our service personnel are available at all times to provide support in commissioning, maintenance and in the event of any emergency situation related to the operation of the equipment.
- ! VTS authorized service stations sell spare parts and accessories for our air handling units. When ordering parts, please specify the type of air handling unit, size and series number.
- ! For more information regarding the VTS service network, visit www.vtsgroup.com.

9.5 TECHNICAL INFORMATION TO REGULATION (U) N327/2011, IMPLEMENTING DIRECTIVE 2009/125/WE

Model:	19/0.16 EC	22/0.37 EC	22/0.75 EC	25/0.37 EC	25/0.75 EC
1.	60,2	60,8%	60,8%	60,8%	60,1%
2.	A	A	A	A	A
3.	Static	Static	Static	Static	Static
4.	62	62	62	62	62
5.	Yes	Yes	Yes	Yes	Yes
6.	2018	2018	2018	2018	2018
7.	VTS, Poland	VTS, Poland	VTS, Poland	VTS, Poland	VTS, Poland
8.	1-2-0294-1750	1-2-0294-1547	1-2-0294-1548	1-2-0205-4001	1-2-0205-4003
9.	169W, 540m ³ /h, 450Pa	370W, 1300m ³ /h, 700Pa	750W, 1550m ³ /h, 1150Pa	370W, 1550m ³ /h, 620Pa	750W, 1950m ³ /h, 1000Pa
10.	4030RPM	3600RPM	4500RPM	3000RPM	3800RPM
11.	1	1	1	1	1
12.	<ul style="list-style-type: none"> Disassembly of the device must be carried out and/or supervised by qualified personnel with appropriate expertise. Contact a nearby company, authorized (certified) for disposal. Establish expectations for the quality of machine disassembly and provisions for components. Disassemble the device based on general procedures commonly used in mechanical engineering. <p>WARNING</p> <ul style="list-style-type: none"> Parts of the machine may fall / fall. The machine is made of heavy components. These components may fall during disassembly. Uncontrolled falling of parts risks death, serious injury or material damage. Safety rules must be observed: <ul style="list-style-type: none"> 1. disconnect all electrical connections 2. protect against accidental reactivation. 3. make sure that the equipment is not live. 4. shield or isolate nearby components that are still live. When connecting electricity to the system, use the reverse order of procedure. Components: these devices consist mostly of steel with varying proportions of copper alloy parts, aluminum alloys and plastics (rotor made of SAN material - styrene, acrylonitrile - a structural material with 20% glass fiber content). Metals are generally considered to be unrestricted materials for recycling. Components should be sorted out for recycling, depending on whether they are: cast iron, steel, aluminum, non-ferrous, such as winding insulation is incinerated during copper recycling, insulating materials, cables and wires, electronic waste, plastic parts (rotors, winding covers, etc.). The same applies to cloths and cleaning substances that were used during work on the machine. Separated components must be disposed of, in accordance with local regulations or through a specialized waste acceptance company. 				
13.	<ul style="list-style-type: none"> Long-term trouble-free operation depends on adherence to the operating and performance limits for the product/device/fan, according to the selection manual or maintenance manual. For proper operation of the equipment, you should carefully read the contents of the maintenance manual, paying special attention to the chapters "Installation", "Commissioning" and maintenance. 				
14.	No additional elements				

DEKLARACJA ZGODNOŚCI UE / EU DECLARATION OF CONFORMITY

My, Producent:
The Manufacturer:

VTS Sp. z o.o.
ul. Aleja Grunwaldzka 472A
80-309 Gdańsk, Poland



Strona internetowa:
Website:

www.vtsgroup.com

Deklarujemy z pełną odpowiedzialności, że wyroby:
We hereby declare that the following products:

Centrale wentylacyjne: *VENTUS*
Air handling units: *VENTUS*

Modele / *Models:*

VVS021, VVS030, VVS040, VVS055, VVS075, VVS100, VVS120, VVS150, VVS180, VVS230, VVS300, VVS400, VVS500, VVS650, VVS010s, VVS015s, VVS005s, VVS020s, VVS030s, VVS021c, VVS030c, VVS040c, VVS055c, VVS075c, VVS100c, VVS120c, VVS150c, VVSA11c, VVSA14c, VVSA22c, VVSA29c, VVSA40c, VVSA56c, VVSA70c, VVS023c, VVS033c, VVS043c.

Rok produkcji: / *Year of manufacture:*

2026

Numer seryjny: / *Serial number:*

od 8-XXX-26-XXXXX-00001 do 8-AXX-26-XXXXX-99999
(*Podano na tabliczce znamionowej/ Specified on the nameplate*)

są zgodne w całości z postanowieniami następujących dyrektyw oraz z następującymi normami oraz standardami:
comply with the provisions of the following directives and with the following norms, standards, internal reports:

DYREKTYWY:
DIRECTIVES:

2006/42/WE Dyrektywa maszynowa
2006/42/EC Machinery Directive

2009/125/WE Dyrektywa Ekoprojektu
2009/125/EC Ecodesign Directive

2014/30/UE Dyrektywa kompatybilności
elektromagnetycznej
2014/30/EU EMC Directive

2011/65/UE, 2015/863/UE Dyrektywa RoHS
2011/65/EU, 2015/863/EU RoHS Directive

2014/35/UE Dyrektywa niskonapięciowa
2014/35/EU Low Voltage Directive

STANDARDY I SPECYFIKACJE:
STANDARDS AND SPECIFICATIONS:

EN ISO 12100:2010 | EN ISO 13857:2019 | EN 60204-1:2018 |
EN IEC 60335-1:2023 | EN 60335-2-40:2015 | EN 50106:2008 |
EN 60529:2014

327/2011 | 1253/2014 | EN 13053:2019

EN 62233:2008 | EN 61000-6-2:2005 | EN 61000-6-3:2007

EN IEC 63000:2018

Imię i nazwisko, stanowisko osoby upoważnionej:

Przemysław Kamiński

Name and position of authorized person:

Chief Technology Officer

Miejsce i data:
Place and date

Gdańsk, 2026.02.06:

VTS sp. z o.o., Al. Grunwaldzka 472 A, 80-309 Gdańsk | NIP: 5871599675 | REGON: 220079570
Sąd Rejonowy Gdańsk – Północ w Gdańsku, Wydział VII Gospodarczy KRS | KRS: 0000239557

Kapitał zakładowy: 150.000,00 PLN | Nr BDO: 000006509 | www.vtsgroup.com

9.6 ADDITIONAL INFORMATION

Routine inspections, carried out by qualified technical personnel or service personnel authorized by VTS, guarantee long-term, reliable and trouble-free operation of the equipment. Our service personnel are available at all times to provide support in commissioning, maintenance and in the event of any emergency situation related to the operation of the equipment.

VTS authorized service stations sell spare parts and accessories for our air handling units. When ordering parts, please specify the type of air handling unit, size and series number

For more information regarding the VTS service network, visit www.vtsgroup.com.



The nameplate of the device includes the sound pressure level LWA (1m) given for a distance of 1m from the device.

To calculate LWA values at a distance of 3m and 5m, use the formula:

- $LWA(3m) = LWA(1m) - 9.54$
- $LWA(5m) = LWA(1m) - 13.98$



Original version of the manual.

VTS reserves the right to make changes without notice